



# Online User's Guide

**DCP-J1100DW**  
**MFC-J1300DW**

## Table of Contents

<b>Before You Use Your Brother Machine .....</b>	<b>1</b>
Definitions of Notes .....	2
Trademarks .....	3
Important Note .....	4
<b>Introduction to Your Brother Machine.....</b>	<b>5</b>
Before Using Your Machine .....	6
Control Panel Overview .....	7
Touchscreen LCD Overview.....	9
Settings Screen Overview .....	14
Navigate the Touchscreen.....	17
Set the Default Screen of the Feature Mode.....	18
Access Brother Utilities (Windows) .....	19
Uninstall the Brother Software and Drivers (Windows) .....	20
USB / Ethernet Port Locations on Your Brother Machine .....	21
<b>Paper Handling.....</b>	<b>23</b>
Load Paper.....	24
Load Paper in the Paper Tray .....	25
Load Paper in the Manual Feed Slot.....	36
Unprintable Area .....	39
Paper Settings.....	40
Acceptable Paper and Other Print Media.....	43
Load Documents .....	50
Load Documents in the Automatic Document Feeder (ADF) .....	51
Load Documents on the Scanner Glass .....	53
Unscannable Area.....	54
<b>Print.....</b>	<b>55</b>
Print from Your Computer (Windows).....	56
Print a Photo (Windows).....	57
Print a Document (Windows).....	58
Cancel a Print Job (Windows).....	59
Print More Than One Page on a Single Sheet of Paper (N in 1) (Windows).....	60
Print as a Poster (Windows).....	61
Print on Both Sides of the Paper Automatically (Automatic 2-sided Printing) (Windows) .....	62
Print as a Booklet Automatically (Windows).....	65
Print a Colour Document in Greyscale (Windows) .....	67
Prevent Smudged Printouts and Paper Jams (Windows) .....	68
Use a Preset Print Profile (Windows) .....	69
Change the Default Print Settings (Windows) .....	72
Print Settings (Windows) .....	73
Print from Your Computer (Mac) .....	77
Print a Photo (Mac) .....	78
Print a Document (Mac) .....	79
Print on Both Sides of the Paper Automatically (Automatic 2-sided Printing) (Mac) .....	80
Print More Than One Page on a Single Sheet of Paper (N in 1) (Mac) .....	81
Print a Colour Document in Greyscale (Mac).....	82

Prevent Smudged Printouts and Paper Jams (Mac) .....	83
Print Options (Mac) .....	84
<b>Scan.....</b>	<b>90</b>
Scan Using the Scan Button on Your Brother Machine .....	91
Scan Photos and Graphics.....	92
Save Scanned Data to a Folder as a PDF File .....	94
Save Scanned Data to a Memory Card or USB Flash Drive.....	96
Scan Multiple Business Cards and Photos (Auto Crop).....	99
Scan to an Editable Text File Using OCR.....	100
Scan to Email Attachment .....	102
Scan to FTP .....	104
Scan to SSH FTP (SFTP) .....	108
Scan to Network (Windows).....	115
Scan to SharePoint .....	120
Web Services for Scanning on Your Network (Windows 7, Windows 8 and Windows 10) .....	124
Change Scan Button Settings from ControlCenter4 (Windows).....	128
Change Scan Button Settings from Brother iPrint&Scan (Mac).....	132
Scan from Your Computer (Windows).....	133
Scan Using ControlCenter4 Home Mode (Windows).....	134
Scan Using ControlCenter4 Advanced Mode (Windows).....	149
Scan Using Nuance™ PaperPort™ 14SE or Other Windows Applications.....	165
Scan Using Windows Fax and Scan .....	170
Install BookScan Enhancer and Whiteboard Enhancer (Windows) .....	174
Scan from Your Computer (Mac).....	175
Scan Using Brother iPrint&Scan (Mac) .....	176
Scan Using TWAIN-Compliant Applications (Mac).....	177
Configure Scan Settings Using Web Based Management.....	180
Set the Scan Job Email Report Using Web Based Management .....	181
<b>Copy .....</b>	<b>182</b>
Copy a Document .....	183
Enlarge or Reduce Copied Images .....	185
Sort Copies .....	186
Make Page Layout Copies ( N in 1 or Poster).....	187
Copy on Both Sides of the Paper (2-sided Copy) .....	189
Copy an ID Card .....	191
Copy in Ink Save Mode .....	193
Copy Options .....	194
<b>Fax .....</b>	<b>197</b>
Send a Fax.....	198
Send a Fax from Your Brother Machine .....	199
Send a Fax Manually.....	201
Send a Fax at the End of a Conversation .....	202
Send the Same Fax to More than One Recipient (Broadcasting) .....	203
Send a Fax in Real Time .....	206
Send a Fax at a Specified Time (Delayed Fax).....	207
Change the Fax Auto Redial Setting .....	208
Cancel a Fax in Progress .....	209

Check and Cancel a Pending Fax.....	210
Fax Options .....	211
Receive a Fax .....	212
Receive Mode Settings .....	213
Set Fax Detect.....	218
Fax Preview.....	219
Shrink Page Size of an Oversized Incoming Fax .....	223
Set the Fax Receive Stamp.....	224
Receive a Fax at the End of a Telephone Conversation .....	225
Memory Receive Options .....	226
Remote Fax Retrieval.....	233
Voice Operations and Fax Numbers .....	239
Voice Operations .....	240
Store Fax Numbers .....	242
Set up Groups for Broadcasting.....	247
Telephone Services and External Devices.....	251
Use BT Call Sign .....	252
Caller ID .....	254
Set the Telephone Line Type.....	256
Voice Over Internet Protocol (VoIP/Telephone Line Interference).....	258
External TAD (Telephone Answering Device).....	259
External and Extension Telephones .....	263
Fax Reports .....	269
Set the Transmission Verification Report's Style.....	270
Set the Fax Journal's Interval Period.....	271
PC-FAX .....	272
PC-FAX for Windows .....	273
PC-FAX for Mac .....	293
<b>PhotoCapture Center .....</b>	<b>296</b>
Print Photos Directly from Media.....	297
Compatible Media .....	298
Important Information about Photo Printing.....	299
Print Photos from Media on the Brother Machine .....	300
Copy Photos from Media to a Computer.....	309
Before Copying Photos .....	310
Copy Photos from Media Over a Local Connection .....	311
Print Photos from ControlCenter4 (Windows).....	312
Edit Photos Using ControlCenter4 (Windows) .....	314
<b>Network .....</b>	<b>316</b>
Configure Network Details Using the Control Panel .....	317
Supported Basic Network Features .....	318
Network Management Software and Utilities .....	319
Learn about Network Management Software and Utilities .....	320
Additional Methods of Configuring Your Brother Machine for a Wireless Network .....	321
Before Configuring Your Brother Machine for a Wireless Network.....	322
Configure Your Machine for a Wireless Network Using the One Push Method of Wi-Fi Protected Setup™ (WPS).....	323

Configure Your Machine for a Wireless Network Using the PIN Method of Wi-Fi Protected Setup™ (WPS).....	324
Configure Your Machine for a Wireless Network When the SSID is Not Broadcast.....	326
Configure Your Machine for an Enterprise Wireless Network .....	328
Use Wi-Fi Direct® .....	330
Advanced Network Features.....	339
Print the Network Configuration Report.....	340
Configure and Operate LDAP Search .....	341
Synchronize Time with the SNTP Server Using Web Based Management .....	344
Technical Information for Advanced Users.....	347
Reset the Network Settings to Factory Default .....	348
Print the WLAN Report.....	349
<b>Security .....</b>	<b>352</b>
Network Security Features .....	353
Before Using Network Security Features .....	354
Secure Function Lock 3.0.....	355
Use Active Directory Authentication .....	362
Use LDAP Authentication .....	366
Manage Your Network Machine Securely Using SSL/TLS.....	370
Manage Your Network Machine Securely Using IPsec .....	393
Send an Email Securely .....	407
Use IEEE 802.1x Authentication for a Wired or a Wireless Network .....	411
<b>Mobile/Web Connect.....</b>	<b>416</b>
Brother Web Connect.....	417
Brother Web Connect Overview .....	418
Online Services Used with Brother Web Connect.....	419
Conditions for Using Brother Web Connect.....	421
Set Up Brother Web Connect.....	425
Scan and Upload Documents Using Brother Web Connect.....	433
Upload a Document from an External Memory Device Using Brother Web Connect .....	434
Download and Print Documents Using Brother Web Connect .....	435
Download and Save a Document to an External Memory Device Using Brother Web Connect.....	438
FaxForward to Cloud or E-mail .....	439
Google Cloud Print.....	442
Google Cloud Print Overview .....	443
Before Using Google Cloud Print .....	444
Print from Google Chrome™ or Chrome OS™ .....	448
Print from Google Drive™ for Mobile .....	449
Print from Gmail™ Webmail Service for Mobile .....	450
AirPrint .....	451
AirPrint Overview.....	452
Before Using AirPrint (macOS) .....	453
Print Using AirPrint .....	454
Scan Using AirPrint (macOS).....	457
Send a Fax Using AirPrint (macOS).....	458
Mobile Printing for Windows.....	459
Mopria® Print Service.....	460

Brother iPrint&Scan for Mobile Devices .....	461
Near-Field Communication (NFC).....	462
<b>ControlCenter .....</b>	<b>463</b>
ControlCenter4 (Windows).....	464
Change the Operation Mode in ControlCenter4 (Windows) .....	465
Scan Using ControlCenter4 Home Mode (Windows).....	467
Scan Using ControlCenter4 Advanced Mode (Windows).....	468
Set Up the Brother Machine Using ControlCenter4 (Windows) .....	469
Create a Custom Tab Using ControlCenter4 Advanced Mode (Windows).....	471
<b>Brother iPrint&amp;Scan for Windows and Mac.....</b>	<b>473</b>
Brother iPrint&Scan Overview.....	474
<b>Troubleshooting .....</b>	<b>475</b>
Error and Maintenance Messages .....	476
Transfer Your Faxes or Fax Journal Report .....	484
Error Messages When Using the Brother Web Connect Feature.....	488
Document Jams .....	490
Document is Jammed in the Top of the ADF Unit .....	491
Document is Jammed inside the ADF Unit.....	492
Remove Paper Scraps Jammed in the ADF .....	493
Printer Jam or Paper Jam .....	494
Paper is Jammed Inside and in the Front of the Machine (Jam A Inside/Front) .....	495
Paper is Jammed in the Front of the Machine (Jam B Front).....	500
Paper is Jammed in the Back of the Machine (Jam C Rear) .....	503
If You Are Having Difficulty with Your Machine .....	506
Paper Handling and Printing Problems .....	507
Telephone and Fax Problems.....	513
Other Problems .....	519
Network Problems .....	521
Google Cloud Print Problems.....	531
AirPrint Problems .....	532
Check the Machine Information .....	533
Reset Your Brother Machine .....	534
Reset Functions Overview .....	535
<b>Routine Maintenance .....</b>	<b>536</b>
Replace the Ink Cartridges.....	537
Clean Your Brother Machine .....	540
Clean the Scanner.....	541
Clean the Print Head from Your Brother Machine .....	543
Clean the Print Head from Your Computer (Windows).....	544
Clean the Print Head from Your Computer (Mac).....	546
Clean the Machine's LCD.....	547
Clean the Outside of the Machine .....	548
Clean the Machine's Printer Platen .....	549
Clean the Paper Feed Rollers .....	550
Clean the Base Pad .....	552
Clean the Paper Pick-up Rollers .....	553
Check Your Brother Machine .....	554

Check the Print Quality.....	555
Check the Print Alignment from Your Brother Machine.....	557
Check the Ink Volume (Page Gauge).....	558
Monitor Machine Status from Your Computer (Windows).....	560
Monitor Machine Status from Your Computer (Mac).....	565
Correct the Paper Feed to Clear Vertical Lines.....	567
Change the Print Setting Options When Having Printing Problems.....	568
Pack and Ship Your Brother Machine.....	569
<b>Machine Settings.....</b>	<b>571</b>
Change Machine Settings from the Control Panel.....	572
In the Event of Power Failure (Memory Storage).....	573
General Settings.....	574
Save Your Favourite Settings as a Shortcut.....	589
Print Reports.....	594
Settings and Features Tables.....	597
Change Machine Settings from Your Computer.....	614
Change Machine Settings Using Web Based Management.....	615
Change the Machine Settings Using Remote Setup.....	620
<b>Appendix.....</b>	<b>632</b>
Specifications.....	633
Supply Specifications.....	640
Enter Text on Your Brother Machine.....	641
Information Regarding Recycled Paper.....	642
Brother Numbers.....	643





## Before You Use Your Brother Machine

- [Definitions of Notes](#)
- [Trademarks](#)
- [Important Note](#)



## Definitions of Notes

We use the following symbols and conventions throughout this User's Guide:

 <b>WARNING</b>	WARNING indicates a potentially hazardous situation which, if not avoided, could result in death or serious injuries.
 <b>CAUTION</b>	CAUTION indicates a potentially hazardous situation which, if not avoided, may result in minor or moderate injuries.
<b>IMPORTANT</b>	IMPORTANT indicates a potentially hazardous situation which, if not avoided, may result in damage to property or loss of product functionality.
<b>NOTE</b>	NOTE specifies the operating environment, conditions for installation, or special conditions of use.
	Tips icons indicate helpful hints and supplementary information.
	Electrical Hazard icons alert you to possible electrical shock.
<b>Bold</b>	Bold style identifies buttons on the machine's control panel or computer screen.
<i>Italics</i>	Italicised style emphasises an important point or refers you to a related topic.
Courier New	Courier New font identifies messages shown on the machine's LCD.



### Related Information

- [Before You Use Your Brother Machine](#)

## Trademarks

Apple, AirPrint, App Store, Mac, Safari, iPad, iPhone, iPod touch and macOS are trademarks of Apple Inc., registered in the United States and other countries.

Nuance and PaperPort are trademarks or registered trademarks of Nuance Communications, Inc. or its affiliates in the United States and/or other countries.

The SDHC Logo is a trademark of SD-3C, LLC.

Wi-Fi®, Wi-Fi Alliance® and Wi-Fi Direct® are registered trademarks of Wi-Fi Alliance®.

WPA™, WPA2™, Wi-Fi Protected Setup™ and Wi-Fi Protected Setup™ logo are trademarks of Wi-Fi Alliance®.

Android, Gmail, Google Cloud Print, Google Drive, Google Play, Google Chrome, Chrome OS and Google are trademarks of Google LLC. Use of these trademarks are subject to Google Permissions.

Mozilla and Firefox are registered trademarks of the Mozilla Foundation.

The Bluetooth® word mark and logos are registered trademarks owned by the Bluetooth SIG, Inc. and any use of such marks by Brother Industries, Ltd. and related companies is under license. Other trademarks and trade names are those of their respective owners.

Intel is a trademark of Intel Corporation in the U.S. and/or other countries.

Evernote and the Evernote Elephant logo are trademarks of Evernote Corporation and used under a license.

Mopria® and the Mopria® logo are registered trademarks and service marks of Mopria Alliance, Inc. in the United States and other countries. Unauthorized use is strictly prohibited.

WordPerfect is a trademark or a registered trademark of Corel Corporation and/or its subsidiaries in Canada, the United States and/or other countries.

Each company whose software title is mentioned in this manual has a Software License Agreement specific to its proprietary programs.

**Any trade names and product names of companies appearing on Brother products, related documents and any other materials are all trademarks or registered trademarks of those respective companies.**



### Related Information

- [Before You Use Your Brother Machine](#)

## Important Note

- Do not use this product outside the country of purchase as it may violate the wireless telecommunication and power regulations of that country.
- Windows 10 in this document represents Windows 10 Home, Windows 10 Pro, Windows 10 Education and Windows 10 Enterprise.
- Windows Server 2008 in this document represents Windows Server 2008 and Windows Server 2008 R2.
- In this User's Guide, the LCD messages of the MFC-J1300DW are used unless otherwise specified.
- In this User's Guide, the illustrations of the MFC-J1300DW are used unless otherwise specified.
- The screens in this User's Guide are for illustration purposes only and may differ from the actual screens.
- Unless otherwise specified, the screens in this manual are from Windows 7 and macOS v10.12.x. Screens on your computer may vary depending on your operating system.
- The contents of this guide and the specifications of this product are subject to change without notice.
- This documentation is for both MFC and DCP models. Read 'XXX-XXXX' as 'MFC/DCP-XXXX' (where XXXX is the name of your model).



### Related Information

- [Before You Use Your Brother Machine](#)
-

## Introduction to Your Brother Machine

- [Before Using Your Machine](#)
- [Control Panel Overview](#)
- [Touchscreen LCD Overview](#)
- [Settings Screen Overview](#)
- [Navigate the Touchscreen](#)
- [Set the Default Screen of the Feature Mode](#)
- [Access Brother Utilities \(Windows\)](#)
- [USB / Ethernet Port Locations on Your Brother Machine](#)

## Before Using Your Machine

Before attempting any printing operation, confirm the following:

- Make sure you have installed the Brother software and drivers.
- For USB or network cable users: Make sure the interface cable is physically secure.

### Selecting the correct type of paper

For high quality printing, it is important to select the correct type of paper. Be sure to read the information about acceptable paper before buying paper, and to determine the printable area depending on the settings in the printer driver.

### Simultaneous printing, scanning and faxing

Your machine can print from your computer while sending or receiving a fax into memory or while scanning a document into the computer. Fax sending will not be stopped during printing from your computer. However, when the machine is copying or receiving a fax on paper, it pauses the printing operation, and then continues printing when copying or fax receiving has finished.



DCP models do not support the fax feature.

### Firewall (Windows)

If your computer is protected by a firewall and you are unable to network print, network scan, or PC-FAX, you may need to configure the firewall settings. If you are using the Windows Firewall and you installed the drivers using the steps in the installer, the necessary firewall settings have been already set. If you are using any other personal firewall software, see the User's Guide for your software or contact the software manufacturer.



### Related Information

- [Introduction to Your Brother Machine](#)

## Control Panel Overview

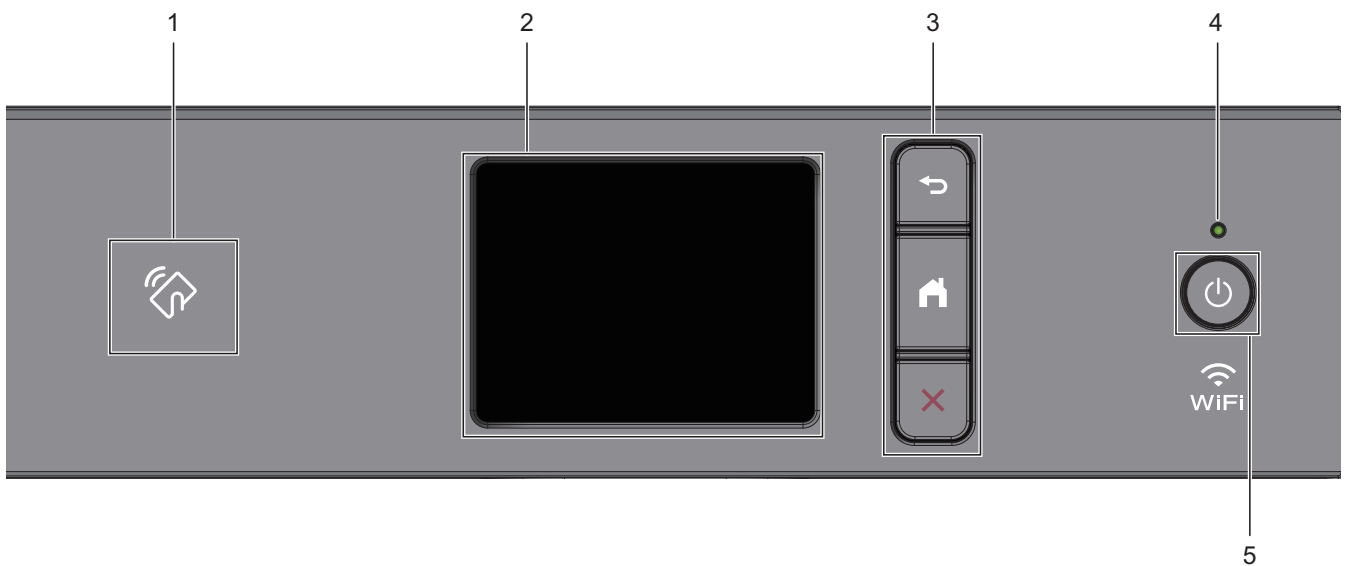

1.  **NFC (Near Field Communication) symbol**

**(MFC-J1300DW)**

If your Android™ device supports the NFC feature, you can print from your device or scan documents to your device by touching it to the NFC logo on the control panel.

2. **Touchscreen Liquid Crystal Display (LCD)**

Access menus and options by pressing them on the touchscreen.

3. **Menu buttons**



Press to go back to the previous menu.



Press to return to the Home screen.



Press to cancel an operation.

4. **LED Power Indicator**

The LED lights up depending on the machine's power status.

When the machine is in Sleep Mode, the LED blinks.

5.  **Power On/Off**

Press  to turn the machine on.

Press and hold down  to turn the machine off. The touchscreen displays [Shutting Down] and stays on for a few seconds before turning itself off. If you have connected an external telephone or TAD, it is always available (MFC models).

If you turn the machine off using , it will still clean the print head periodically to maintain print quality. To prolong print head life, provide better ink efficiency, and maintain print quality, keep your machine connected to a power source at all times.



## Related Information

- [Introduction to Your Brother Machine](#)

### **Related Topics:**

- [Near-Field Communication \(NFC\)](#)
-

## Touchscreen LCD Overview

- >> MFC-J1300DW
- >> DCP-J1100DW

### MFC-J1300DW

You can switch Home screens by pressing ◀ or ▶.

From the Home screens, you can access the Wi-Fi® setup, Shortcuts, Ink levels, and Settings screens.

#### Home Screen

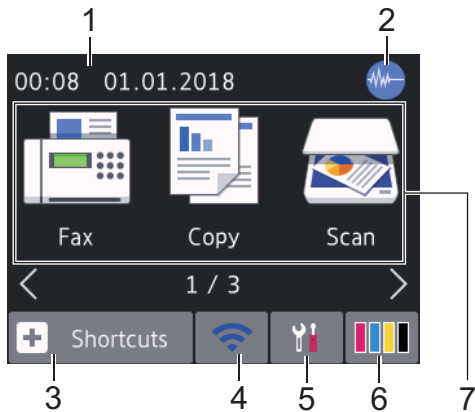

This screen shows the machine's status when the machine is idle. When displayed, it indicates that your machine is ready for the next command.

#### 1. Date & Time

Displays the date and time set on the machine.

#### 2. Quiet Mode

This icon appears when the [Quiet Mode] setting is set to [On].

The Quiet Mode setting can reduce printing noise. When Quiet Mode is turned on, the print speed becomes slower.

#### 3. [Shortcuts]

Create Shortcuts for frequently-used operations, such as sending a fax, copying, scanning, Web Connect and Apps services.



- There are three Shortcuts screens. You can program four shortcuts on each screen.

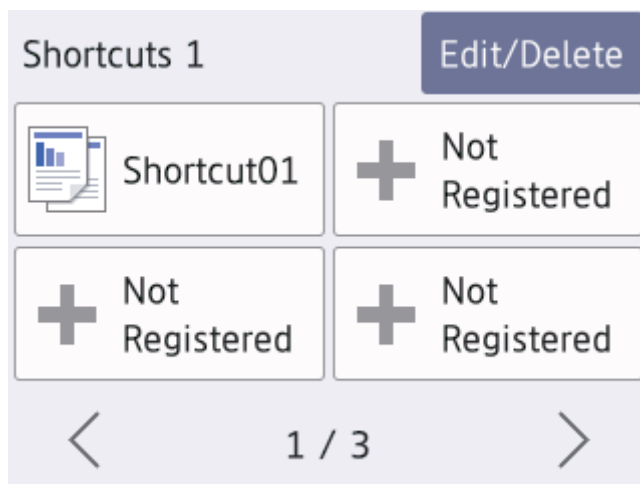





- To display the other Shortcuts screens, press ◀ or ▶.

#### 4. Wireless Status



Each icon in the following table shows the wireless network status:

	Your machine is not connected to the wireless access point/router. Press this button to configure wireless settings. For more detailed information, see the <i>Quick Setup Guide</i> .
	The wireless network is connected. A three-level indicator in each of the Home screens displays the current wireless signal strength.
	The wireless access point/router cannot be detected.
	The wireless setting is disabled.



You can configure wireless settings by pressing the Wireless Status button.

5.  [Settings]

Press to access the [Settings] menu.

6.  [Ink]

Displays the approximate available ink volume. Press to access the [Ink] menu.

When an ink cartridge is near the end of its life or having a problem, an error icon is displayed on the ink colour.

7. **Modes:**

Press to switch to each mode.

[Fax] / [Copy] / [Scan] / [Photo] / [Web] / [Apps] / [Download Software]

8. **Information icon**

8

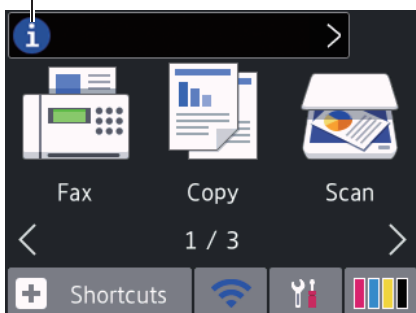

New information from Brother appears in the information bar when the notification settings such as [Message from Brother] and [Firmware Auto Check] are set to [On].



(Internet connection is needed, and data rates may apply.)

Press  to view the details.

9. **Warning icon**

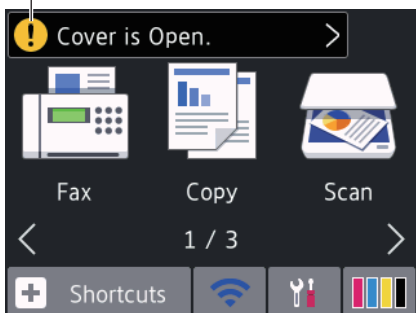
9



The warning icon  appears when there is an error or maintenance message; press  to view the details, and then press  to return to the Home screen.

## DCP-J1100DW

You can switch Home screens by pressing ◀ or ▶.

From the Home screens, you can access the Wi-Fi® setup, Shortcuts, Ink levels, and Setup screens.

### Home Screen

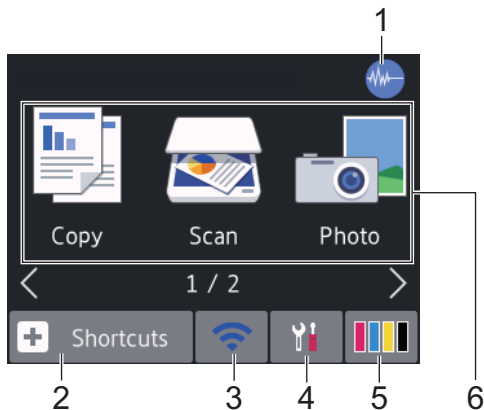

This screen shows the machine's status when the machine is idle. When displayed, it indicates that your machine is ready for the next command.

#### 1. Quiet Mode

This icon appears when the [Quiet Mode] setting is set to [On].

The Quiet Mode setting can reduce printing noise. When Quiet Mode is turned on, the print speed becomes slower.

#### 2. [Shortcuts]

Create Shortcuts for frequently-used operations, such as copying, scanning, Web Connect and Apps services.



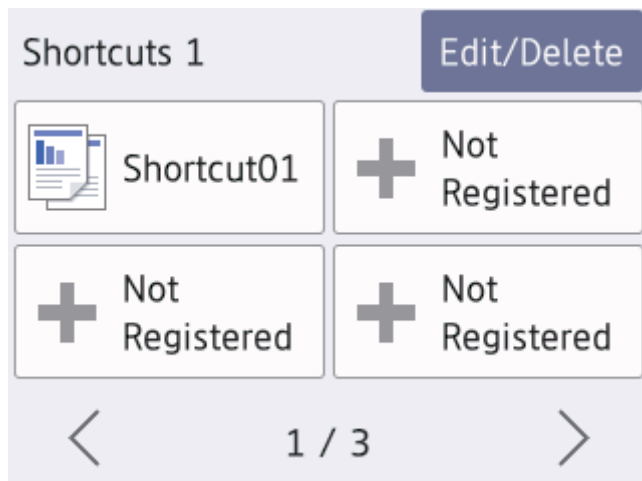

- There are three Shortcuts screens. You can program four shortcuts on each screen.



- To display the other Shortcuts screens, press ◀ or ▶.

#### 3. Wireless Status

Each icon in the following table shows the wireless network status:

	Your machine is not connected to the wireless access point/router. Press this button to configure wireless settings. For more detailed information, see the <i>Quick Setup Guide</i> .
	The wireless network is connected. A three-level indicator in each of the Home screens displays the current wireless signal strength.

	The wireless access point/router cannot be detected.
	The wireless setting is disabled.

You can configure wireless settings by pressing the Wireless Status button.

4. [Settings]

Press to access the [Settings] menu.

5. [Ink]

Displays the approximate available ink volume. Press to access the [Ink] menu.

When an ink cartridge is near the end of its life or having a problem, an error icon is displayed on the ink colour.

6. **Modes:**

Press to switch to each mode.

[Copy] / [Scan] / [Photo] / [Web] / [Apps] / [Download Software]

7. **Information icon**

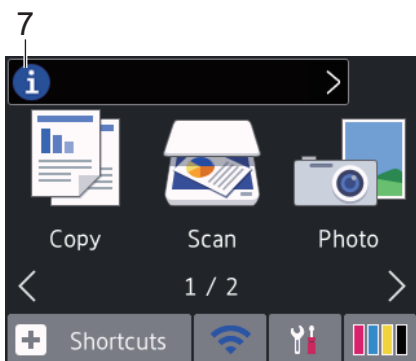

New information from Brother appears in the information bar when the notification settings such as [Message from Brother] and [Firmware Auto Check] are set to [On].

(Internet connection is needed, and data rates may apply.)

Press to view the details.

8. **Warning icon**

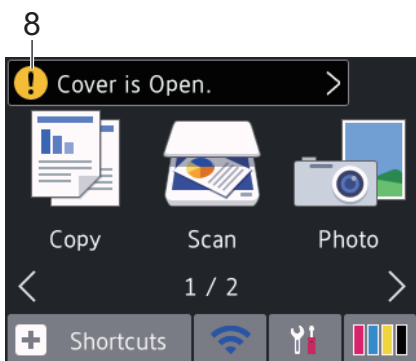

The warning icon appears when there is an error or maintenance message; press to view the details, and then press to return to the Home screen.

**Related Information**

- [Introduction to Your Brother Machine](#)

**Related Topics:**

- [Reduce Printing Noise](#)

- 
- Check the Ink Volume (Page Gauge)
  - Settings Screen Overview
  - Error and Maintenance Messages
-

## Settings Screen Overview

>> MFC-J1300DW  
>> DCP-J1100DW

### MFC-J1300DW

The touchscreen shows the machine's status when you press  [Settings].

Use the Settings menu to access all of your Brother machine's settings.

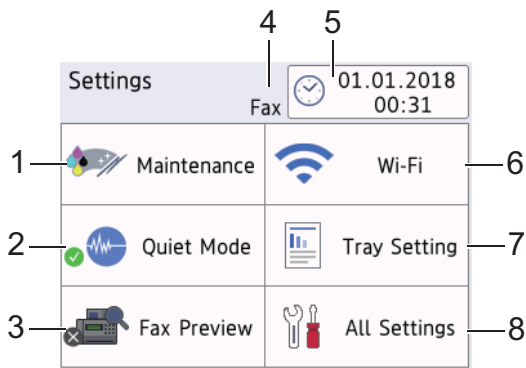

#### 1. [Maintenance]

Press to access the following menus:

- [Improve Print Quality]
- [Print Head Cleaning]
- [Ink Volume]
- [Ink Cartridge Model]
- [Print Setting Options]

#### 2. [Quiet Mode]

Displays the Quiet Mode setting.

Press to access the [Quiet Mode] menu.

When this menu is set to [On],  is displayed on the Home screen.

#### 3. [Fax Preview]

Displays the Fax Preview setting.

Press to access the [Fax Preview] menu.

#### 4. Receive Mode

Displays the current Receive Mode.

#### 5. [Date & Time]

Displays the date and time.

Press to access the [Date & Time] menu.

#### 6. [Wi-Fi]

Press to set up a wireless network connection.

If you are using a wireless connection, a three-level indicator  on the screen displays the current wireless signal strength.

#### 7. [Tray Setting]

Press to access the [Tray Setting] menu.

Use options in the Tray setting menu to change the paper size and type.

## 8. [All Settings]

Press to access a menu of all of your machine's settings.

### DCP-J1100DW

The touchscreen shows the machine's status when you press  [Settings].

Use the Settings menu to access all of your Brother machine's settings.

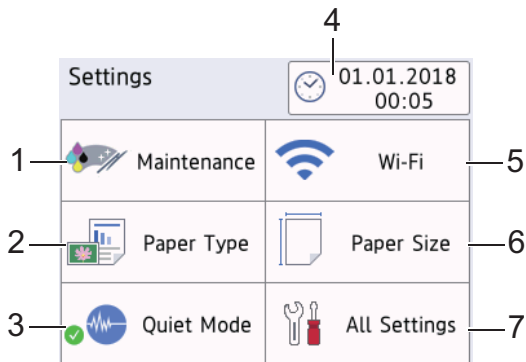

#### 1. [Maintenance]

Press to access the following menus:

- [Improve Print Quality]
- [Print Head Cleaning]
- [Ink Volume]
- [Ink Cartridge Model]
- [Print Setting Options]

#### 2. [Paper Type]

Press to access the [Paper Type] menu.

Use this option to change the paper type.

#### 3. [Quiet Mode]

Displays the Quiet Mode setting.

Press to access the [Quiet Mode] menu.

When this menu is set to [On],  is displayed on the Home screen.

#### 4. [Date & Time]

Displays the date and time.

Press to access the [Date & Time] menu.

#### 5. [Wi-Fi]

Press to set up a wireless network connection.

If you are using a wireless connection, a three-level indicator  on the screen displays the current wireless signal strength.

#### 6. [Paper Size]

Press to access the [Paper Size] menu.

Use this option to change the paper size.

#### 7. [All Settings]

Press to access a menu of all of your machine's settings.

### Related Information

- [Introduction to Your Brother Machine](#)

---

**Related Topics:**

- [Touchscreen LCD Overview](#)
  - [Check the Ink Volume \(Page Gauge\)](#)
-

## Navigate the Touchscreen

Press your finger on the LCD to operate it. To display and access all the options, press ◀▶ or ▲▼ on the LCD to scroll through them.

### NOTE

- This product adopts the font of ARPHIC TECHNOLOGY CO., LTD.





### Related Information

- [Introduction to Your Brother Machine](#)



## Set the Default Screen of the Feature Mode

You can change the default screen of the Scan mode.

1. Press  [Settings] > [All Settings] > [General Setup] > [Screen Settings] > [Scan Screen].
2. Press ▲ or ▼ to display the scan options, and then press the option you want in the default screen.
3. Press .



### Related Information

- [Introduction to Your Brother Machine](#)
-

## Access Brother Utilities (Windows)

**Brother Utilities** is an application launcher that offers convenient access to all Brother applications installed on your computer.

1. Do one of the following:

- Windows 7

Click  (**Start**) > **All Programs** > **Brother** > **Brother Utilities**.

- Windows 8

Tap or click  (**Brother Utilities**) either on the **Start** screen or the desktop.

- Windows 8.1

Move your mouse to the lower left corner of the **Start** screen and click  (if using a touch-based device, swipe up from the bottom of the **Start** screen to bring up the **Apps** screen).

When the **Apps** screen appears, tap or click  (**Brother Utilities**).

- Windows 10

Click  > **Brother** > **Brother Utilities**.

2. Select your machine.

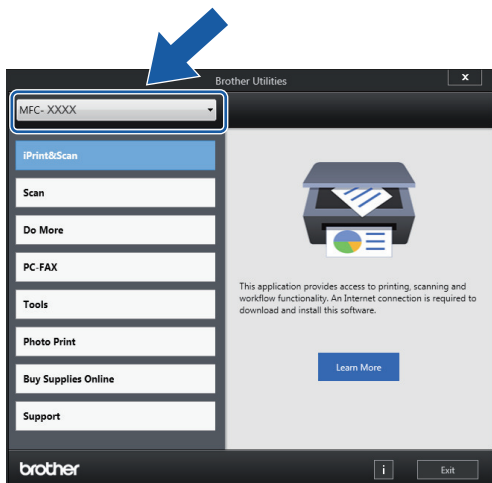

3. Select the operation you want to use.

### Related Information

- [Introduction to Your Brother Machine](#)
  - [Uninstall the Brother Software and Drivers \(Windows\)](#)

## Uninstall the Brother Software and Drivers (Windows)

1. Do one of the following:

- Windows 7

Click  (**Start**) > **All Programs** > **Brother** > **Brother Utilities**.

- Windows 8

Tap or click  (**Brother Utilities**) either on the **Start** screen or the desktop.

- Windows 8.1

Move your mouse to the lower left corner of the **Start** screen and click  (if using a touch-based device, swipe up from the bottom of the **Start** screen to bring up the **Apps** screen).

When the **Apps** screen appears, tap or click  (**Brother Utilities**).

- Windows 10

Click  > **Brother** > **Brother Utilities**.

2. Click the drop-down list, and then select your model name (if not already selected). Click **Tools** in the left navigation bar, and then click **Uninstall**.

Follow the instructions in the dialog box to uninstall the software and drivers.



### Related Information

- [Access Brother Utilities \(Windows\)](#)

## USB / Ethernet Port Locations on Your Brother Machine

The USB and Ethernet ports are located inside the machine.

- When connecting the USB or Ethernet cable, follow the instructions in the installation process.
- To install the **Full Driver & Software Package** necessary for operating your machine, insert the Brother installation disc into your computer, or go to your model's **Downloads** page on the Brother Solutions Center at [support.brother.com](http://support.brother.com).

1. Place both hands under the plastic tabs on both sides of the machine to lift the scanner cover (1) into the open position.

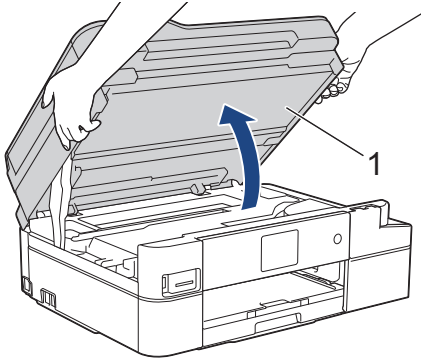

2. Locate the correct port (based on the cable you are using) inside the machine as shown.

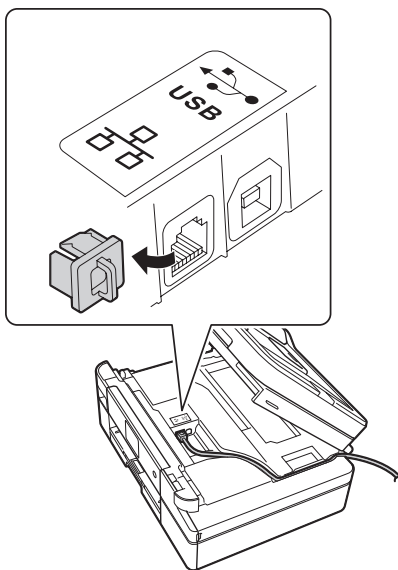

 Carefully guide the cable through the cable channel and out the back of the machine.

3. Gently close the scanner cover using both hands.

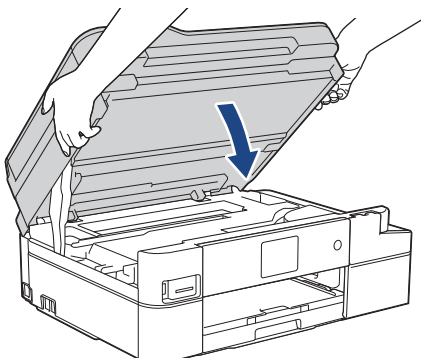



## Related Information

- [Introduction to Your Brother Machine](#)

## Paper Handling

- [Load Paper](#)
- [Load Documents](#)

## Load Paper

- [Load Paper in the Paper Tray](#)
- [Load Paper in the Manual Feed Slot](#)
- [Unprintable Area](#)
- [Paper Settings](#)
- [Acceptable Paper and Other Print Media](#)
- [Error and Maintenance Messages](#)
- [Paper Handling and Printing Problems](#)

## Load Paper in the Paper Tray

- Load Cut-Sheet Paper or Photo 2L Paper in the Paper Tray
- Load Photo Paper in the Paper Tray
- Load Envelopes in the Paper Tray



## Load Cut-Sheet Paper or Photo 2L Paper in the Paper Tray

- If the [Check Paper] setting is set to [On] and you pull the paper tray out of the machine, a message appears on the LCD asking if you want to change the paper type and paper size.
- Load only one size and type of paper in the paper tray at a time.
- When you load a different paper size in the tray, you must change the Paper Size setting in the machine or the paper size setting on your computer.

1. If the paper support flap (1) is open, close it, and then close the paper support (2).

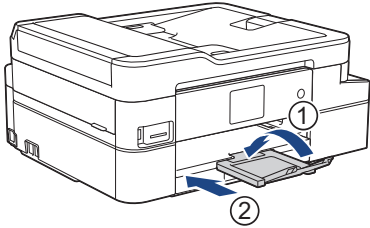

2. Pull the paper tray completely out of the machine.

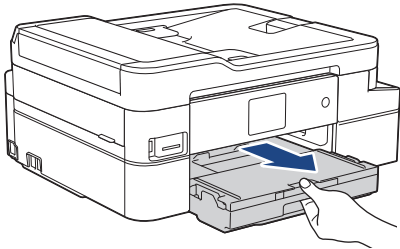

3. Open the output paper tray cover (1).

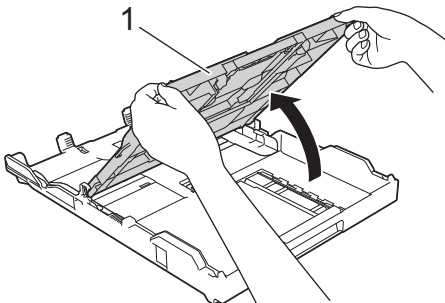

4. Gently press and slide the paper width guides (1) and then the paper length guide (2) to fit the paper size.

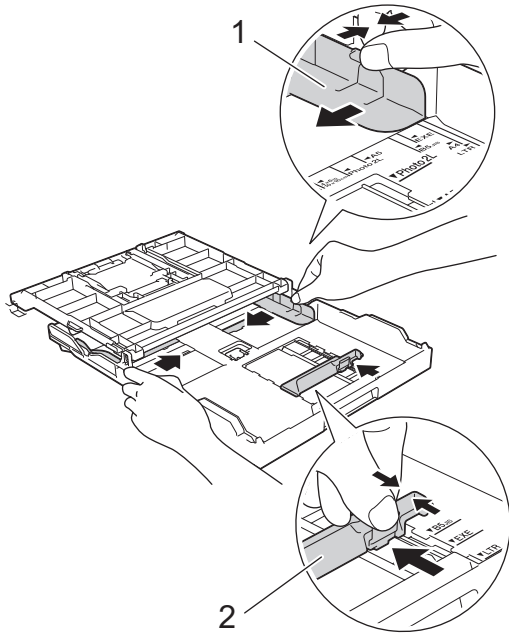

5. Fan the stack of paper well to avoid paper jams and misfeeds.

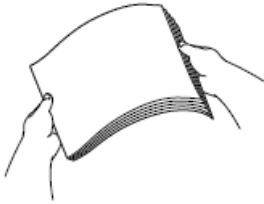

 Always make sure the paper is not curled or wrinkled.

6. Gently load paper in the paper tray with the printing surface **face down**.

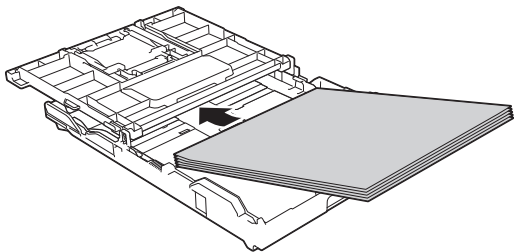

Make sure the paper is flat in the tray and the paper length guide (1) touches the edges of the paper.

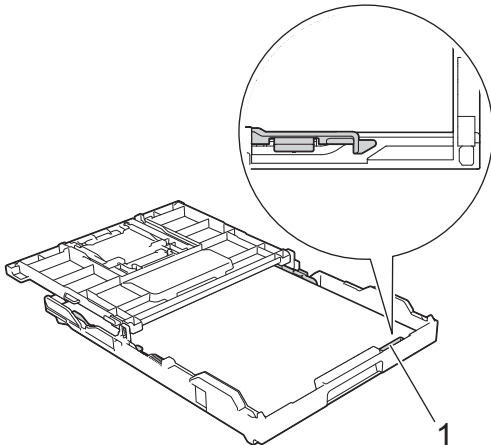

## IMPORTANT

- Be careful not to push the paper in too far; it may lift at the back of the tray and cause paper feed problems.
- Loading more than 20 sheets of Photo 2L (13 x 18 cm) paper may cause paper jams.



To add paper before the tray is empty, remove the paper from the tray and combine it with the paper you are adding. Always fan the stack of paper well to prevent the machine from feeding multiple pages.

7. Gently adjust the paper width guides (1) to fit the paper.  
Make sure the paper width guides touch the edges of the paper.

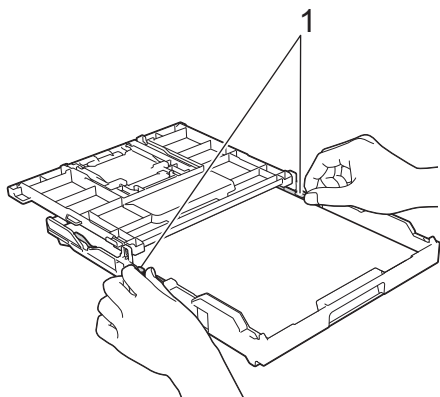

8. Close the output paper tray cover.

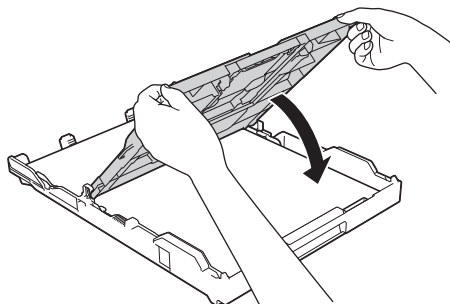

9. Slowly push the paper tray completely into the machine.

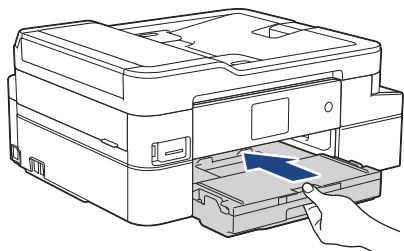

10. Pull out the paper support (1) until it locks into place, and then unfold the paper support flap (2).

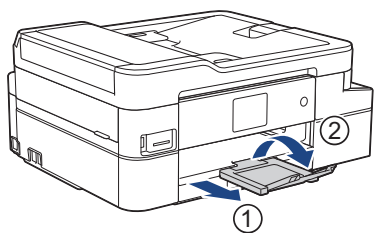

### Related Information

- [Load Paper in the Paper Tray](#)

---

**Related Topics:**

- [Change the Check Paper Size Setting](#)
  - [Choose the Right Print Media](#)
  - [Change the Paper Size and Paper Type](#)
-

## Load Photo Paper in the Paper Tray

- If the [Check Paper] setting is set to [On] and you pull the paper tray out of the machine, a message appears on the LCD asking if you want to change the paper type and paper size.
- Load only one size and type of paper in the paper tray at a time.
- When you load a different paper size in the tray, you must change the Paper Size setting in the machine or the paper size setting on your computer.

1. If the paper support flap (1) is open, close it, and then close the paper support (2).

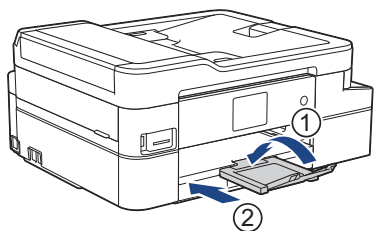

2. Pull the paper tray completely out of the machine.

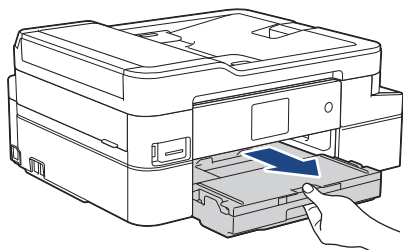

3. Open the output paper tray cover (1).

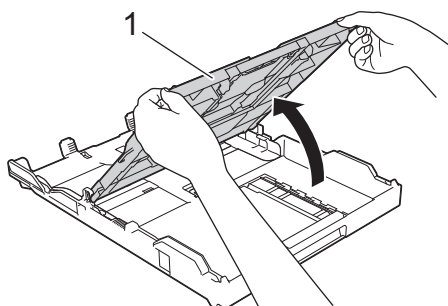

4. Gently press and slide the paper width guides (1) to fit the paper size, and then lift up the stopper (2).

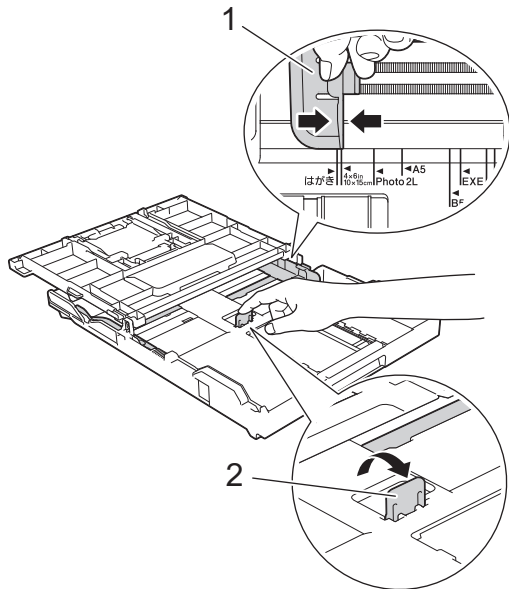

5. Close the output paper tray cover.

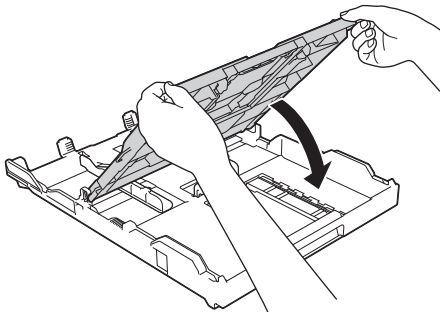

6. Load up to 20 sheets of photo paper with the printing surface **face down**.  
Loading more than 20 sheets of photo paper may cause paper jams.

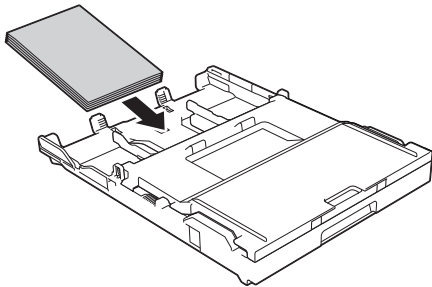

7. Gently adjust the paper width guides (1) to fit the paper.  
Make sure the paper width guides touch the edges of the paper and the paper is flat in the tray.

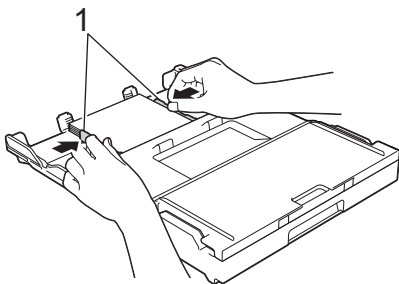

8. Slowly push the paper tray completely into the machine.

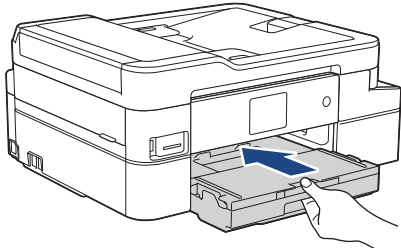

9. Pull out the paper support (1) until it locks into place, and then unfold the paper support flap (2).

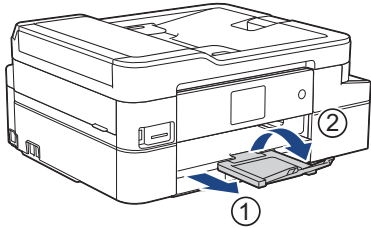

### Related Information

- [Load Paper in the Paper Tray](#)

#### Related Topics:

- [Change the Check Paper Size Setting](#)
  - [Choose the Right Print Media](#)
  - [Change the Paper Size and Paper Type](#)
-

## Load Envelopes in the Paper Tray

- If the [Check Paper] setting is set to [On] and you pull the paper tray out of the machine, a message appears on the LCD asking if you want to change the paper type and paper size.
- You can load envelopes in a variety of sizes. See *Related Information: Paper Type and Paper Size for Each Operation*.
- When you load a different paper size in the tray, you must change the Paper Size setting in the machine or the paper size setting on your computer.
- Before loading envelopes in the tray, press the corners and sides of the envelopes to make them as flat as possible.

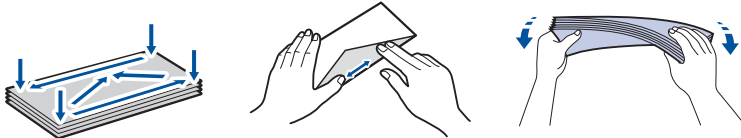

1. If the paper support flap (1) is open, close it, and then close the paper support (2).

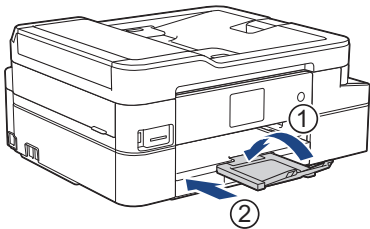

2. Pull the paper tray completely out of the machine.

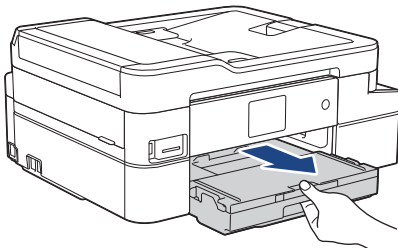

3. Open the output paper tray cover (1).

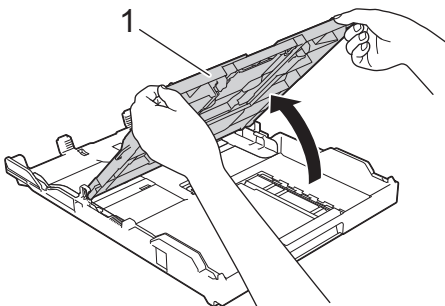

4. Load up to 10 envelopes in the paper tray with the printing surface **face down**. Loading more than 10 envelopes may cause paper jams.



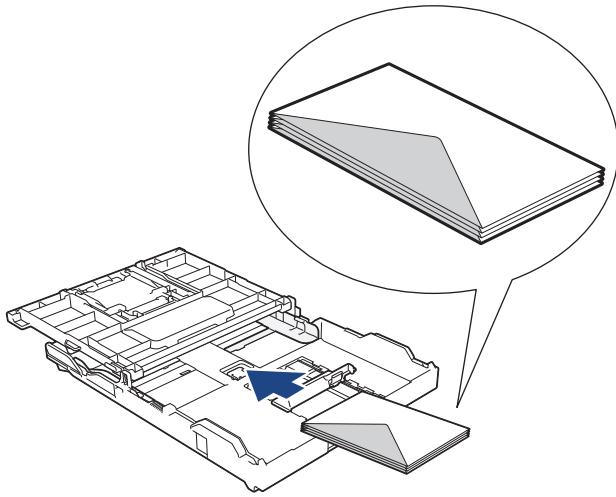

5. Gently press and slide the paper width guides (1) and paper length guide (2) to fit the size of the envelopes. Make sure the envelopes are flat in the tray.

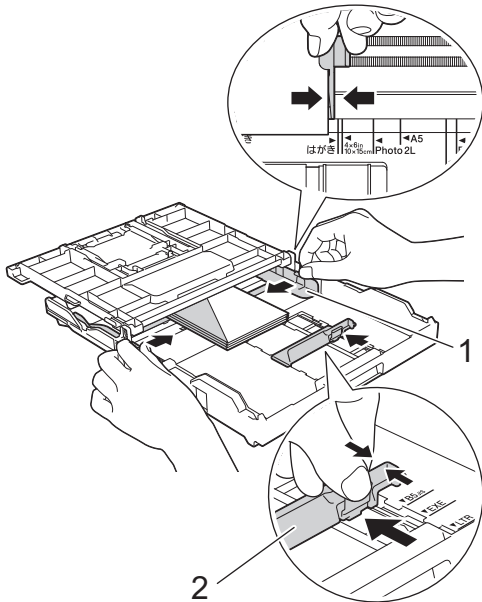

## IMPORTANT

If envelopes are "double-feeding," load one envelope in the paper tray at a time.

6. Close the output paper tray cover.

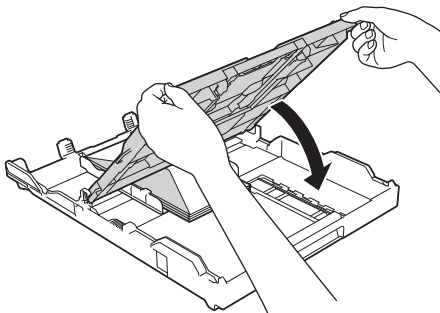

7. Slowly push the paper tray completely into the machine.

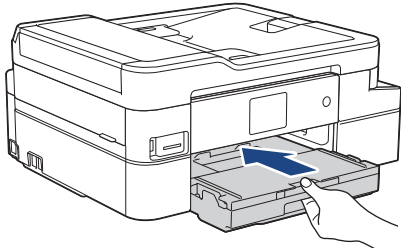

8. Pull out the paper support (1) until it locks into place, and then unfold the paper support flap (2).

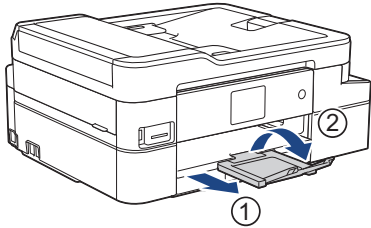

### ✓ Related Information

- [Load Paper in the Paper Tray](#)

#### **Related Topics:**

- [Change the Check Paper Size Setting](#)
  - [Choose the Right Print Media](#)
  - [Change the Paper Size and Paper Type](#)
  - [Paper Type and Paper Size for Each Operation](#)
-

## Load Paper in the Manual Feed Slot

Load special print media in this slot, **one sheet of paper** at a time.



The machine automatically turns on Manual Feed mode when you put paper in the manual feed slot.

1. Open the manual feed slot cover.

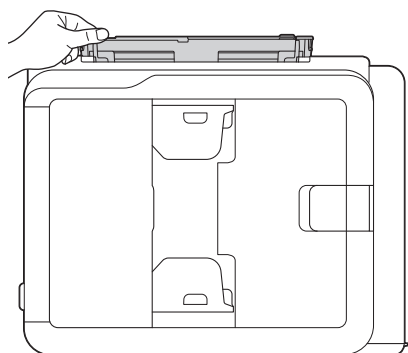
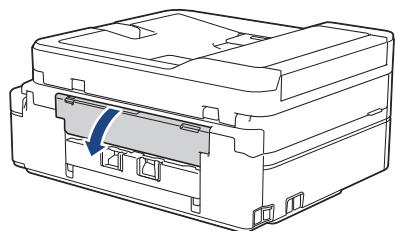

2. Lift up the paper support.

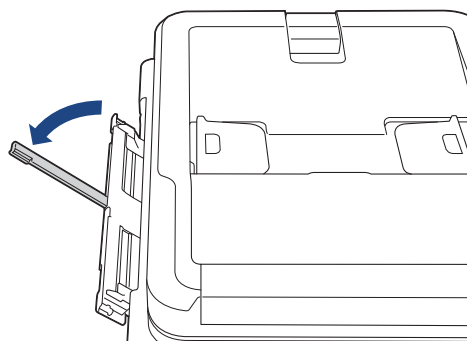

3. Slide the manual feed slot paper guides to fit the width of the paper you are using.

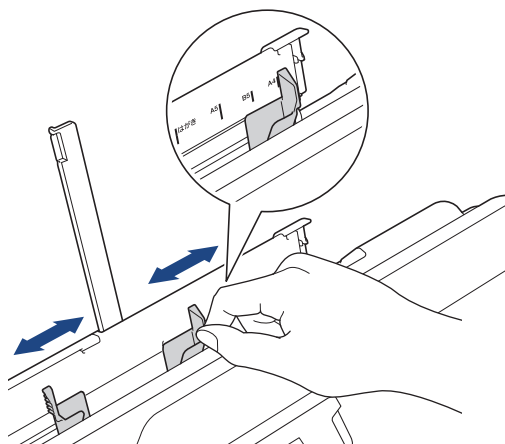

4. Load only **one sheet of paper** in the manual feed slot with the printing surface **face up**.

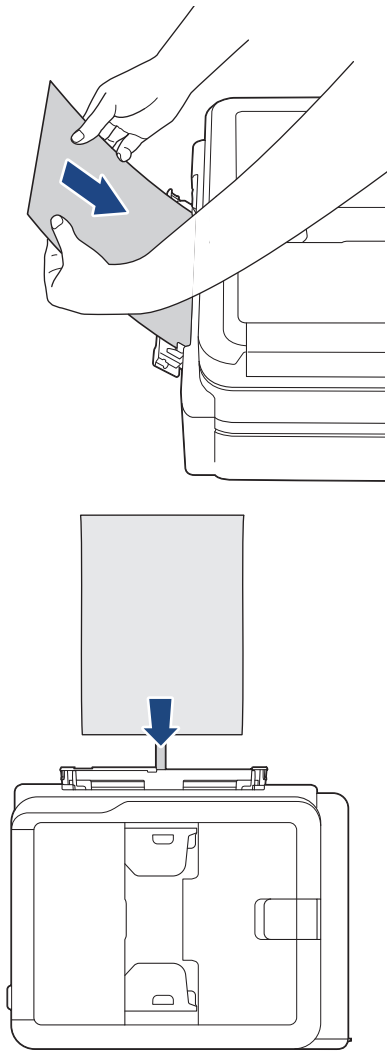

 When using envelopes, load the envelopes with the printing surface **face up** and the flap on the left as shown in the illustration.

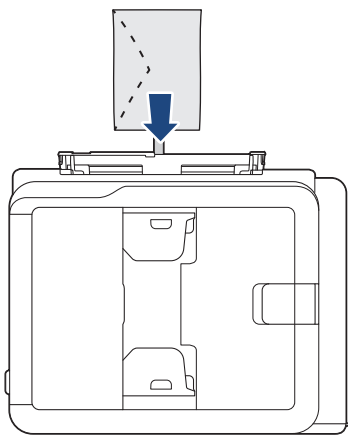

## IMPORTANT

- DO NOT load more than **one sheet of paper** in the manual feed slot at any time. Doing this may cause a paper jam. When printing multiple pages, do not feed the next sheet of paper until the LCD displays a message instructing you to feed the next sheet.
- DO NOT load paper in the manual feed slot when you are printing from the paper tray. Doing this may cause a paper jam.

- 
5. Using both hands, push **one sheet of paper** into the manual feed slot until the front edge touches the paper feed rollers. Let go of the paper when you hear the machine pull it. The LCD displays [Manual Feed Slot ready]. Read the instruction displayed on the LCD, and then press [OK].

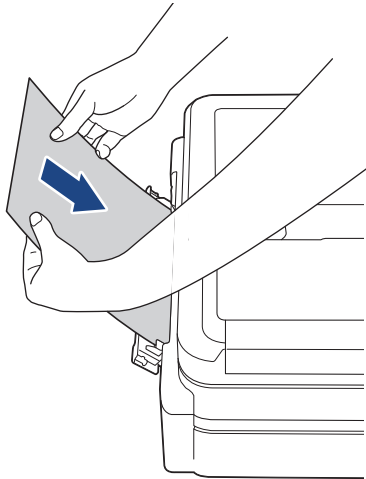

---

When loading an envelope, or a sheet of thick paper, push the envelope into the manual feed slot until you feel the paper feed rollers pull it.

---

6. Pull out the paper support (1) until it locks into place, and then unfold the paper support flap (2).

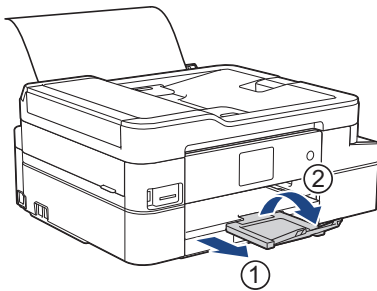

- If the document does not fit on one sheet, the machine will prompt you to load another sheet of paper. Place another sheet of paper in the manual feed slot, and then press [OK] on the machine's control panel.
  - Make sure printing has finished before you close the manual feed slot cover.
  - When paper is placed in the manual feed slot, the machine always prints from the manual feed slot.
  - The machine will eject paper loaded in the manual feed slot while a test page, fax, or report is being printed.
  - The machine will eject paper loaded in the manual feed slot during the machine's cleaning process. Wait until the machine finishes its cleaning, and then load paper in the manual feed slot.
- 



## Related Information

- [Load Paper](#)

### Related Topics:

- [Choose the Right Print Media](#)
  - [Error and Maintenance Messages](#)
-

## Unprintable Area

The unprintable area depends on the settings in the application you are using. The figures below show the unprintable areas on cut-sheet paper and envelopes. The machine can print in the shaded areas of cut-sheet paper only when the Borderless print feature is available and turned on.

### Cut-Sheet Paper

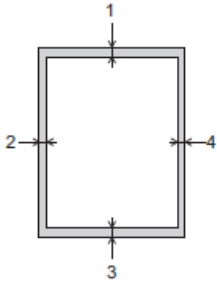

### Envelopes

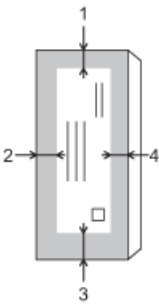

	Top (1)	Left (2)	Bottom (3)	Right (4)
Cut-Sheet	3 mm	3 mm	3 mm	3 mm
Envelopes	12 mm	3 mm	12 mm	3 mm



The Borderless print feature is not available for envelopes and 2-sided printing.



### Related Information

- [Load Paper](#)

#### Related Topics:



- [Paper Handling and Printing Problems](#)

## Paper Settings

- [Change the Paper Size and Paper Type](#)
- [Change the Check Paper Size Setting](#)
- [Shrink Page Size of an Oversized Incoming Fax](#)

## Change the Paper Size and Paper Type

Set the Paper Size and Paper Type settings for the paper tray.

- To get the best print quality, set the machine for the type of paper you are using.
  - When you change the size of the paper you load in the tray, you must change the Paper Size setting on the LCD at the same time.
1. Press  [Settings] > [All Settings] > [General Setup].
  2. Press [Paper Type].
  3. Press ▲ or ▼ to display the paper type options, and then press the option you want.
  4. Press [Paper Size].
  5. Press ▲ or ▼ to display the paper size options, and then press the option you want.
  6. Press .



The machine ejects paper with the printed surface face up onto the paper tray at the front of the machine. When you use glossy paper, remove each sheet at once to prevent smudging or paper jams.

### Related Information

- [Paper Settings](#)

#### Related Topics:



- [Load Cut-Sheet Paper or Photo 2L Paper in the Paper Tray](#)
- [Load Photo Paper in the Paper Tray](#)
- [Load Envelopes in the Paper Tray](#)
- [Acceptable Paper and Other Print Media](#)
- [Error and Maintenance Messages](#)
- [Paper Handling and Printing Problems](#)



## Change the Check Paper Size Setting

If this setting is set to [On] and you pull the paper tray out of the machine, the LCD displays a message asking if you want to change the Paper Size and Paper Type settings.

The default setting is [On].

1. Press  [Settings] > [All Settings] > [General Setup].
2. Press ▲ or ▼ to display the [Check Paper] option, and then press it.
3. Press [On] or [Off].
4. Press .



### Related Information

- [Paper Settings](#)

#### Related Topics:

- [Load Cut-Sheet Paper or Photo 2L Paper in the Paper Tray](#)
- [Load Photo Paper in the Paper Tray](#)
- [Load Envelopes in the Paper Tray](#)
- [Error and Maintenance Messages](#)

## Acceptable Paper and Other Print Media

The print quality can be affected by the type of paper you use in the machine.

To get the best print quality for the settings you have selected, always set the Paper Type to match the type of paper you load.

You can use plain paper, inkjet paper (coated paper), glossy paper, recycled paper and envelopes.

We recommend testing various paper types before buying large quantities.

For best results, use Brother paper.

- When you print on inkjet paper (coated paper) and glossy paper, be sure to select the correct print media in the **Basic** tab of the printer driver or in the Paper Type setting on the machine.
- When you print on Brother Photo paper, load one extra sheet of the same photo paper in the paper tray.
- When using photo paper, remove each sheet at once to prevent smudging or paper jams.
- Avoid touching the printed surface of the paper immediately after printing; the surface may not be completely dry and may stain your fingers.



### Related Information

- [Load Paper](#)
  - [Recommended Print Media](#)
  - [Handle and Use Print Media](#)
  - [Choose the Right Print Media](#)

### Related Topics:

- [Change the Paper Size and Paper Type](#)
  - [Paper Handling and Printing Problems](#)
-

## Recommended Print Media

For the best print quality, we recommend using the Brother paper listed in the table.

If Brother paper is not available in your country, we recommend testing various paper types before purchasing large quantities.

### Brother paper

Paper Type	Item
A4 Plain	BP60PA
A4 Glossy Photo	BP71GA4
A4 Inkjet (Matte)	BP60MA
10 x 15 cm Glossy Photo	BP71GP



### Related Information

- [Acceptable Paper and Other Print Media](#)

## Handle and Use Print Media

- Store paper in its original packaging and keep it sealed. Keep the paper flat and away from moisture, direct sunlight and heat.
- Avoid touching the shiny (coated) side of photo paper.
- Some envelope sizes require that you set margins in the application. Make sure you do a test print first before printing many envelopes.

### IMPORTANT

DO NOT use the following kinds of paper:

- Damaged, curled, wrinkled, or irregularly shaped

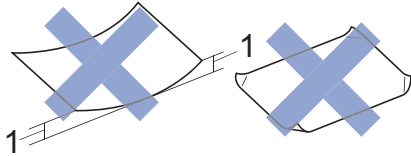

1. **2 mm or greater curl may cause jams to occur.**

- Extremely shiny or highly textured
- Paper that cannot be arranged uniformly when stacked
- Paper made with a short grain

DO NOT use envelopes that:

- Are loosely constructed
- Have windows
- Are embossed (have raised writing on them)
- Have clasps or staples
- Are pre-printed on the inside
- Are self-adhesive
- Have double flaps

#### Self-adhesive Double flaps

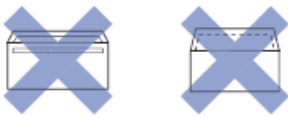

You may experience paper feed problems caused by the thickness, size and flap shape of the envelopes you are using.



### Related Information

- [Acceptable Paper and Other Print Media](#)

#### Related Topics:

- [Load Paper in the Paper Tray](#)

## Choose the Right Print Media

- Paper Type and Paper Size for Each Operation
- Paper Capacity of the Paper Trays
- Paper Weight and Thickness
- Load Cut-Sheet Paper or Photo 2L Paper in the Paper Tray
- Load Photo Paper in the Paper Tray
- Load Envelopes in the Paper Tray
- Load Paper in the Manual Feed Slot

## Paper Type and Paper Size for Each Operation

Paper Type	Paper Size		Usage			
			Fax <sup>1</sup>	Copy	Photo Capture <sup>2</sup>	Printer
Cut-Sheet	A4	210 x 297 mm	Yes	Yes	Yes	Yes
	Letter	215.9 x 279.4 mm	Yes	Yes	Yes	Yes
	Executive	184.1 x 266.7 mm	-	-	-	Yes
	A5	148 x 210 mm	-	Yes	-	Yes
	A6	105 x 148 mm	-	-	-	Yes
Cards	Photo	10 x 15 cm	-	Yes	Yes	Yes
	Photo L	9 x 13 cm	-	-	-	Yes
	Photo 2L	13 x 18 cm	-	-	Yes	Yes
	Index Card	13 x 20 cm	-	-	-	Yes
Envelopes	C5 Envelope	162 x 229 mm	-	-	-	Yes
	DL Envelope	110 x 220 mm	-	-	-	Yes
	Com-10	104.7 x 241.3 mm	-	-	-	Yes
	Monarch	98.4 x 190.5 mm	-	-	-	Yes

<sup>1</sup> MFC models only

<sup>2</sup> DCP-J1100DW/MFC-J1300DW only



### Related Information

- [Choose the Right Print Media](#)

#### Related Topics:

- [Load Envelopes in the Paper Tray](#)

## Paper Capacity of the Paper Trays

	Paper Size	Paper Types	No. of sheets
Paper Tray	A4, Letter, Executive, A5, A6, Envelopes (C5, Com-10, DL, Monarch), Photo (10 x 15 cm), Photo 2L (13 x 18 cm), Index card (13 x 20 cm)	Plain Paper, Recycled Paper	150 <sup>1</sup>
		Inkjet Paper	20
		Glossy Paper, Photo	20
		Index Card	30
		Envelopes	10
Manual Feed Slot	A4, Letter, Executive, A5, A6, Envelopes (C5, Com-10, DL, Monarch), Photo (10 x 15 cm), Photo L (9 x 13 cm), Photo 2L (13 x 18 cm), Index card (13 x 20 cm)	Plain Paper, Inkjet Paper, Glossy Paper, Recycled Paper, Photo and Envelopes	1

<sup>1</sup> When using plain paper 80 g/m<sup>2</sup>



### Related Information

- [Choose the Right Print Media](#)

## Paper Weight and Thickness

Paper Type		Weight	Thickness
Cut-Sheet	Plain Paper, Recycled Paper	64 to 120 g/m <sup>2</sup>	0.08 to 0.15 mm
	Inkjet Paper	64 to 200 g/m <sup>2</sup>	0.08 to 0.25 mm
	Glossy Paper <sup>1 2</sup>	Up to 220 g/m <sup>2</sup>	Up to 0.25 mm
Cards	Photo Card <sup>1 2</sup>	Up to 220 g/m <sup>2</sup>	Up to 0.25 mm
	Index Card <sup>2</sup>	Up to 120 g/m <sup>2</sup>	Up to 0.15 mm
Envelopes		80 to 95 g/m <sup>2</sup>	Up to 0.52 mm

<sup>1</sup> BP71 260 g/m<sup>2</sup> paper is specially designed for Brother inkjet machines.

<sup>2</sup> Up to 300 g/m<sup>2</sup> for Manual Feed Slot



### Related Information

- [Choose the Right Print Media](#)

#### Related Topics:

- [Paper Handling and Printing Problems](#)



## Load Documents

- [Load Documents in the Automatic Document Feeder \(ADF\)](#)
- [Load Documents on the Scanner Glass](#)
- [Unscannable Area](#)

## Load Documents in the Automatic Document Feeder (ADF)

The ADF can hold multiple pages and feeds each sheet individually.

Use paper that is within the sizes and weights shown in the table. Always fan the pages before placing them in the ADF.

### Document Sizes and Weights

Length <sup>1</sup> :	148 to 355.6 mm
Width:	148 to 215.9 mm
Paper Weight:	64 to 90 g/m <sup>2</sup>

<sup>1</sup> Documents that are longer than 297 mm must be fed one page at a time.

### IMPORTANT

- DO NOT pull on the document while it is feeding.
- DO NOT use paper that is curled, wrinkled, folded, ripped, stapled, paper clipped, pasted or taped.
- DO NOT use cardboard, newspaper or fabric.
- Make sure documents with correction fluid or written in ink are completely dry.

1. Lift up and unfold the ADF document support (1).

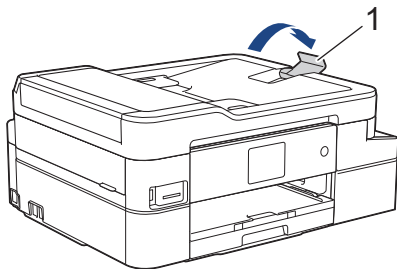

2. Fan the stack of paper well to avoid paper jams and misfeeds.
3. Adjust the paper guides (1) to fit the document size.

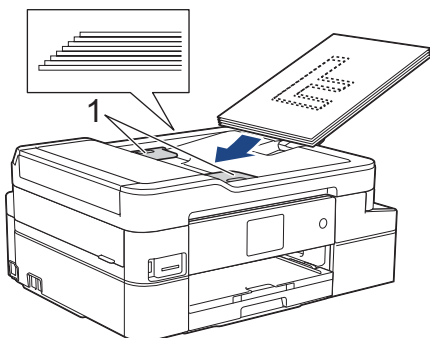

4. Place your document, **face down, top edge first** in the ADF underneath the paper guides until you feel the document touch the feed rollers and the LCD displays [ADF Ready].

### IMPORTANT

DO NOT leave any documents on the scanner glass. If you do this, the ADF may jam.

### ✓ Related Information

- [Load Documents](#)

---

**Related Topics:**

- [Copy a Document](#)
  - [Error and Maintenance Messages](#)
  - [Telephone and Fax Problems](#)
  - [Other Problems](#)
-

## Load Documents on the Scanner Glass

Use the scanner glass to fax, copy, or scan one page at a time.

### Document Sizes Supported

Length:	Up to 297 mm
Width:	Up to 215.9 mm
Weight:	Up to 2 kg



(ADF models)

To use the scanner glass, the ADF must be empty and the ADF document support must be closed.

1. Lift the document cover.
2. Place the document **face down** in the upper left corner of the scanner glass as shown in the illustration.

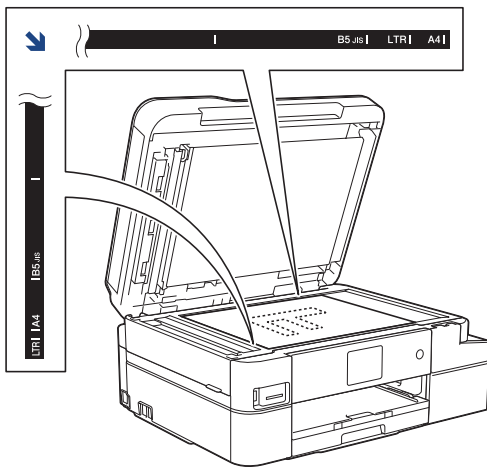

3. Close the document cover.

### IMPORTANT

If you are scanning a book or thick document, DO NOT slam or press on the document cover.



### Related Information

- [Load Documents](#)

#### Related Topics:

- [Copy a Document](#)
- [Telephone and Fax Problems](#)
- [Other Problems](#)

## Unscannable Area

The unscannable area of a page depends on the settings in the application you are using. The figures below show the typical unscannable measurements.

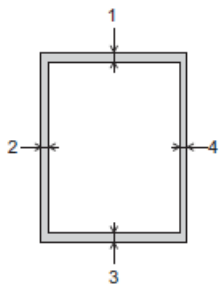

Usage	Document Size	Top (1) Bottom (3)	Left (2) Right (4)
Fax	A4	3 mm	3 mm <sup>1</sup>
	Letter		4 mm
	Legal		
Copy	All paper sizes		3 mm
Scan		1 mm	1 mm

<sup>1</sup> The unscannable area is 1 mm when using the ADF.



### Related Information

- [Load Documents](#)

## Print

- [Print from Your Computer \(Windows\)](#)
- [Print from Your Computer \(Mac\)](#)

## Print from Your Computer (Windows)

- [Print a Photo \(Windows\)](#)
- [Print a Document \(Windows\)](#)
- [Cancel a Print Job \(Windows\)](#)
- [Print More Than One Page on a Single Sheet of Paper \(N in 1\) \(Windows\)](#)
- [Print as a Poster \(Windows\)](#)
- [Print on Both Sides of the Paper Automatically \(Automatic 2-sided Printing\) \(Windows\)](#)
- [Print as a Booklet Automatically \(Windows\)](#)
- [Print a Colour Document in Greyscale \(Windows\)](#)
- [Prevent Smudged Printouts and Paper Jams \(Windows\)](#)
- [Use a Preset Print Profile \(Windows\)](#)
- [Change the Default Print Settings \(Windows\)](#)
- [Print Settings \(Windows\)](#)

## Print a Photo (Windows)



1. Select the print command in your application.
2. Select **Brother MFC-XXXX Printer** (where XXXX is the name of your model), and then click the printing properties or preferences button.  
The printer driver window appears.
3. Make sure you have loaded the correct media in the paper tray.

### IMPORTANT

- For best results, use Brother paper.
- When you print on Brother photo paper, load one extra sheet of the same photo paper in the paper tray.

4. Click the **Basic** tab.
5. Click the **Media Type** drop-down list, and then select the type of paper you are using.

### IMPORTANT

To get the best print quality for the settings you have selected, always set the **Media Type** option to match the type of paper you load.

6. Click the **Paper Size** drop-down list, and then select your paper size.
7. Select the **Borderless** check box, if needed.
8. For **Colour Mode**, select the **Natural** or **Vivid** option.
9. In the **Orientation** field, select the **Portrait** or **Landscape** option to set the orientation of your printout.



If your application contains a similar setting, we recommend that you set the orientation using the application.

10. Type the number of copies (1-999) you want in the **Copies** field.
11. Change other printer settings, if needed.
12. Click **OK**.
13. Complete your print operation.



### Related Information

- [Print from Your Computer \(Windows\)](#)

#### Related Topics:

- [Print Settings \(Windows\)](#)



## Print a Document (Windows)

1. Select the print command in your application.
2. Select **Brother MFC-XXXX Printer** (where XXXX is the name of your model), and then click the printing properties or preferences button.  
The printer driver window appears.
3. Make sure you have loaded the correct size paper in the paper tray.
4. Click the **Basic** tab.
5. Click the **Media Type** drop-down list, and then select the type of paper you are using.

### IMPORTANT

To get the best print quality for the settings you have selected, always set the **Media Type** option to match the type of paper you load.

6. Click the **Paper Size** drop-down list, and then select your paper size.
7. For **Colour Mode**, select the **Natural** or **Vivid** option.
8. In the **Orientation** field, select the **Portrait** or **Landscape** option to set the orientation of your printout.



If your application contains a similar setting, we recommend that you set the orientation using the application.

9. Type the number of copies (1-999) you want in the **Copies** field.
10. To print multiple pages on a single sheet of paper or print one page of your document on multiple sheets, click the **Multiple Page** drop-down list, and then select your options.
11. Change other printer settings, if needed.
12. Click **OK**.
13. Complete your print operation.



### Related Information

- [Print from Your Computer \(Windows\)](#)

#### Related Topics:

- [Check the Ink Volume \(Page Gauge\)](#)
- [Print Settings \(Windows\)](#)

## Cancel a Print Job (Windows)

If a print job was sent to the print queue and did not print, or was sent to the print queue in error, you may have to delete it to allow subsequent jobs to print.

1. Double-click the printer icon  in the task tray.
2. Select the print job you want to cancel.
3. Click the **Document** menu.
4. Select **Cancel**.
5. Click **Yes**.



### Related Information

- [Print from Your Computer \(Windows\)](#)

#### Related Topics:

- [Monitor Machine Status from Your Computer \(Windows\)](#)
-

## Print More Than One Page on a Single Sheet of Paper (N in 1) (Windows)



1. Select the print command in your application.
2. Select **Brother MFC-XXXX Printer** (where XXXX is the name of your model), and then click the printing properties or preferences button.  
The printer driver window appears.
3. Click the **Basic** tab.
4. In the **Orientation** field, select the **Portrait** or **Landscape** option to set the orientation of your printout.



---

If your application contains a similar setting, we recommend that you set the orientation using the application.

---

5. Click the **Multiple Page** drop-down list, and then select the **2 in 1**, **4 in 1**, **9 in 1**, or **16 in 1** option.
6. Click the **Page Order** drop-down list, and then select your page order.
7. Click the **Border Line** drop-down list, and then select your border line type.
8. Change other printer settings, if needed.
9. Click **OK**, and then complete your print operation.



### Related Information

- [Print from Your Computer \(Windows\)](#)

#### Related Topics:

- [Print Settings \(Windows\)](#)
-

## Print as a Poster (Windows)

Enlarge your print size and print the document in poster mode.

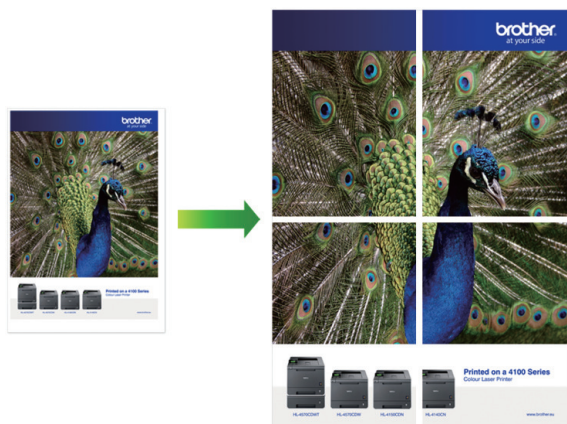

1. Select the print command in your application.
2. Select **Brother MFC-XXXX Printer** (where XXXX is the name of your model), and then click the printing properties or preferences button.  
The printer driver window appears.
3. Click the **Basic** tab.
4. Click the **Multiple Page** drop-down list, and then select the **1 in 2x2 pages** or **1 in 3x3 pages** option.
5. Change other printer settings, if needed.
6. Click **OK**.
7. Complete your print operation.



### Related Information

- [Print from Your Computer \(Windows\)](#)

#### Related Topics:

- [Print Settings \(Windows\)](#)

## Print on Both Sides of the Paper Automatically (Automatic 2-sided Printing) (Windows)

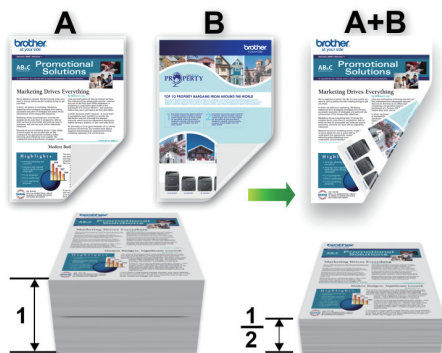

- Make sure the jam clear cover is closed.
- If paper is curled, straighten it and put it back in the paper tray.
- Use regular paper. DO NOT use bond paper.
- If the paper is thin, it may wrinkle.

1. Select the print command in your application.
2. Select **Brother MFC-XXXX Printer** (where XXXX is the name of your model), and then click the printing properties or preferences button.  
The printer driver window appears.
3. Click the **Basic** tab.
4. In the **Orientation** field, select the **Portrait** or **Landscape** option to set the orientation of your printout.



If your application contains a similar setting, we recommend that you set the orientation using the application.

5. Click the **2-sided / Booklet** drop-down list, and then select **2-sided**.
6. Click the **2-sided Settings** button.
7. Select one of the options from the **2-sided Type** menu.

When 2-sided is selected, four types of 2-sided binding are available for each orientation:

Option for Portrait	Description
<b>Long Edge (Left)</b>	
<b>Long Edge (Right)</b>	

Option for Portrait	Description
---------------------	-------------

Short Edge (Top)

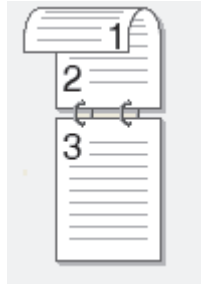

Short Edge (Bottom)

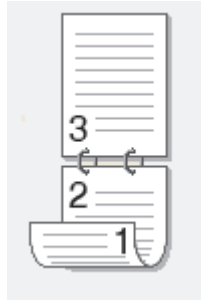

Option for Landscape	Description
----------------------	-------------

Long Edge (Top)

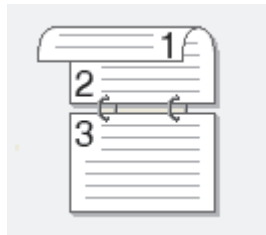

Long Edge (Bottom)



Short Edge (Right)

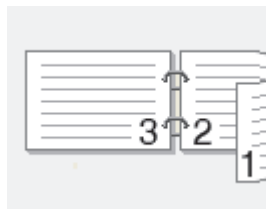

Short Edge (Left)

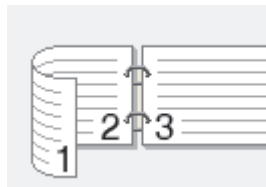

8. Select the **Binding Offset** check box if you want to specify the offset for binding in inches or millimetres.
9. Click **OK** to return to the printer driver window.
10. Change other printer settings, if needed.



The Borderless feature is not available when using this option.

11. Click **OK** again, and then complete your print operation.



## Related Information

- [Print from Your Computer \(Windows\)](#)

### **Related Topics:**

- [Print Settings \(Windows\)](#)
  - [Print as a Booklet Automatically \(Windows\)](#)
-

## Print as a Booklet Automatically (Windows)

Use this option to print a document in booklet format using 2-sided printing. The document's pages will be arranged according to the correct page number and will allow you to fold at the centre of the print output without having to change the order of the printed pages.



- Make sure the jam clear cover is closed.
- If paper is curled, straighten it and put it back in the paper tray.
- Use regular paper. DO NOT use bond paper.
- If the paper is thin, it may wrinkle.

1. Select the print command in your application.
2. Select **Brother MFC-XXXX Printer** (where XXXX is the name of your model), and then click the printing properties or preferences button.  
The printer driver window appears.
3. Click the **Basic** tab.
4. In the **Orientation** field, select the **Portrait** or **Landscape** option to set the orientation of your printout.



If your application contains a similar setting, we recommend that you set the orientation using the application.

5. Click the **2-sided / Booklet** drop-down list, and then select the **Booklet** option.
6. Click the **2-sided Settings** button.
7. Select one of the options from the **2-sided Type** menu.

There are two types of 2-sided binding directions available for each orientation:

Option for Portrait	Description
<b>Left Binding</b>	
<b>Right Binding</b>	



Option for Landscape	Description
----------------------	-------------

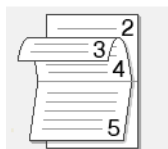

**Top Binding**

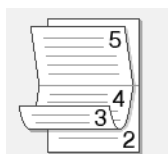

**Bottom Binding**



8. Select one of the options from the **Booklet Printing Method** menu.

Option	Description
<b>All Pages at Once</b>	Every page will be printed in booklet format (four pages to every piece of paper, two pages per side). Fold your printout in the middle to create the booklet. 
<b>Divide into Sets</b>	This option prints the whole booklet in smaller individual booklet sets, allowing you to fold at the centre of the smaller individual booklet sets without having to change the order of the printed pages. You can specify the number of sheets in each smaller booklet set (from 1-15). This option can be helpful when folding a printed booklet that has a large number of pages. 

9. Select the **Binding Offset** check box if you want to specify the offset for binding in inches or millimetres.

10. Click **OK** to return to the printer driver window.

11. Change other printer settings, if needed.



The Borderless feature is not available when using this option.

12. Click **OK**.

13. Complete your print operation.



### Related Information

- [Print from Your Computer \(Windows\)](#)

**Related Topics:**

- [Print Settings \(Windows\)](#)
- [Print on Both Sides of the Paper Automatically \(Automatic 2-sided Printing\) \(Windows\)](#)

## Print a Colour Document in Greyscale (Windows)

Greyscale mode makes the print processing speed faster than colour mode. If your document contains colour, selecting Greyscale mode prints your document in 256 levels of greyscale.

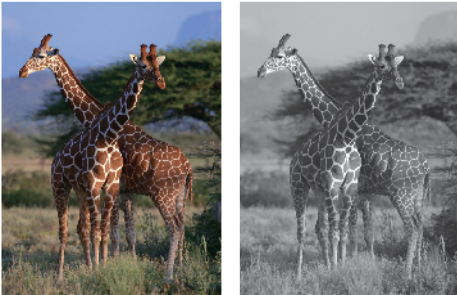

1. Select the print command in your application.
2. Select **Brother MFC-XXXX Printer** (where XXXX is the name of your model), and then click the printing properties or preferences button.  
The printer driver window appears.
3. Click the **Advanced** tab.
4. For **Colour / Greyscale**, select **Greyscale**.
5. Change other printer settings, if needed.
6. Click **OK**.
7. Complete your print operation.



### Related Information

- [Print from Your Computer \(Windows\)](#)

## Prevent Smudged Printouts and Paper Jams (Windows)

Some types of print media may need more drying time. Change the **Reduce Smudge** option if you have problems with smudged printouts or paper jams.

1. Select the print command in your application.
2. Select **Brother MFC-XXXX Printer** (where XXXX is the name of your model), and then click the printing properties or preferences button.  
The printer driver window appears.
3. Click the **Advanced** tab.
4. Click the **Other Print Options** button.
5. Select the **Reduce Smudge** option on the left side of the screen.
6. Select one of the following options:

Media Type	Option	Description	
Plain Paper	2-sided Printing or Simplex Printing	Off	Select this mode to print at normal speed, using a normal amount of ink.
		Low	Select this mode to print at a slower speed, using a normal amount of ink.
		High	Select this mode to print at the same speed as <b>Low</b> , but using less ink.

7. Click **OK** to return to the printer driver window.
8. Click **OK**.
9. Complete your print operation.



### Related Information

- [Print from Your Computer \(Windows\)](#)

#### Related Topics:

- [Paper Handling and Printing Problems](#)
- [Change the Print Setting Options When Having Printing Problems](#)

## Use a Preset Print Profile (Windows)

**Print Profiles** are presets designed to give you quick access to frequently-used printing configurations.

1. Select the print command in your application.
2. Select **Brother MFC-XXXX Printer** (where XXXX is the name of your model), and then click the printing properties or preferences button.  
The printer driver window appears.
3. Click the **Print Profiles** tab.

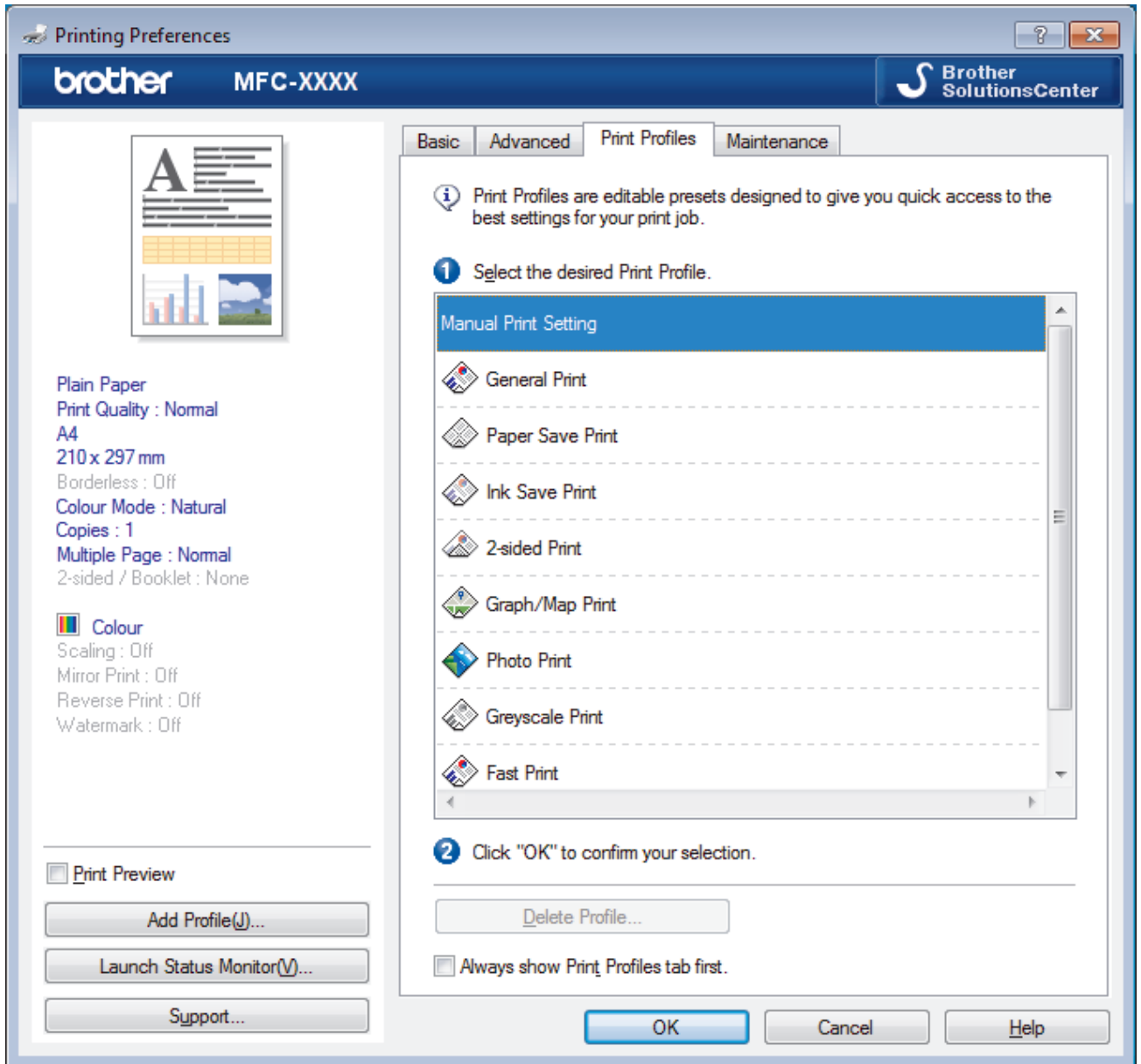

4. Select your profile from the print profile list.  
The profile settings are shown on the left side of the printer driver window.
5. Do one of the following:
  - If the settings are correct for your print job, click **OK**.
  - To change the settings, go back to the **Basic** or **Advanced** tab, change settings, and then click **OK**.



To display the **Print Profiles** tab at the front of the window the next time you print, select the **Always show Print Profiles tab first**. check box.



## Related Information

- [Print from Your Computer \(Windows\)](#)
  - [Create or Delete Your Print Profile \(Windows\)](#)

### Related Topics:

- [Print Settings \(Windows\)](#)
-

## Create or Delete Your Print Profile (Windows)

Add up to 20 new print profiles with customised settings.

1. Select the print command in your application.
2. Select **Brother MFC-XXXX Printer** (where XXXX is the name of your model), and then click the printing properties or preferences button.  
The printer driver window appears.
3. Click the **Basic** tab and the **Advanced** tab, and configure the print settings you want for the new Print Profile.
4. Click the **Print Profiles** tab.
5. Do one of the following:

### To create a new print profile:

- a. Click **Add Profile**.  
The **Add Profile** dialog box appears.
- b. Type the new profile name in the **Name** field.
- c. Click the icon you want to use to represent this profile from the icon list.
- d. Click **OK**.

The new Print Profile name is added to the list in the **Print Profiles** tab.

### To delete a print profile that you created:

- a. Click **Delete Profile**.  
The **Delete Profile** dialog box appears.
- b. Select the profile you want to delete.
- c. Click **Delete**.
- d. Click **Yes**.
- e. Click **Close**.





### Related Information

- [Use a Preset Print Profile \(Windows\)](#)

## Change the Default Print Settings (Windows)

When you change an application's print settings, the changes only apply to documents printed with that application. To change print settings for all Windows applications, you must configure the printer driver properties.

- Do one of the following:
  - For Windows Server 2008  
Click  (**Start**) > **Control Panel** > **Hardware and Sound** > **Printers**.
  - For Windows 7 and Windows Server 2008 R2  
Click  (**Start**) > **Devices and Printers**.
  - For Windows 8  
Move your mouse to the lower right corner of your desktop. When the menu bar appears, click **Settings**, and then click **Control Panel**. In the **Hardware and Sound** group, click **View devices and printers**.
  - For Windows 10 and Windows Server 2016  
Click  > **Windows System** > **Control Panel**. In the **Hardware and Sound** group, click **View devices and printers**.
  - For Windows Server 2012  
Move your mouse to the lower right corner of your desktop. When the menu bar appears, click **Settings**, and then click **Control Panel**. In the **Hardware** group, click **View devices and printers**.
  - For Windows Server 2012 R2  
Click **Control Panel** on the **Start** screen. In the **Hardware** group, click **View devices and printers**.
- Right-click the **Brother MFC-XXXX Printer** icon (where XXXX is your model name), and then select **Printer properties**. If printer driver options appear, select your printer driver.  
The printer driver dialog box appears.
- Click the **General** tab, and then click the **Printing Preferences...** or **Preferences...** button.  
The printer driver dialog box appears.
- Select the print settings you want to use as defaults for all of your Windows programs.
- Click **OK**.
- Close the printer properties dialog box.



### Related Information

- [Print from Your Computer \(Windows\)](#)

#### Related Topics:

- [Print Settings \(Windows\)](#)

## Print Settings (Windows)

- >> Basic Tab
- >> Advanced Tab

### Basic Tab

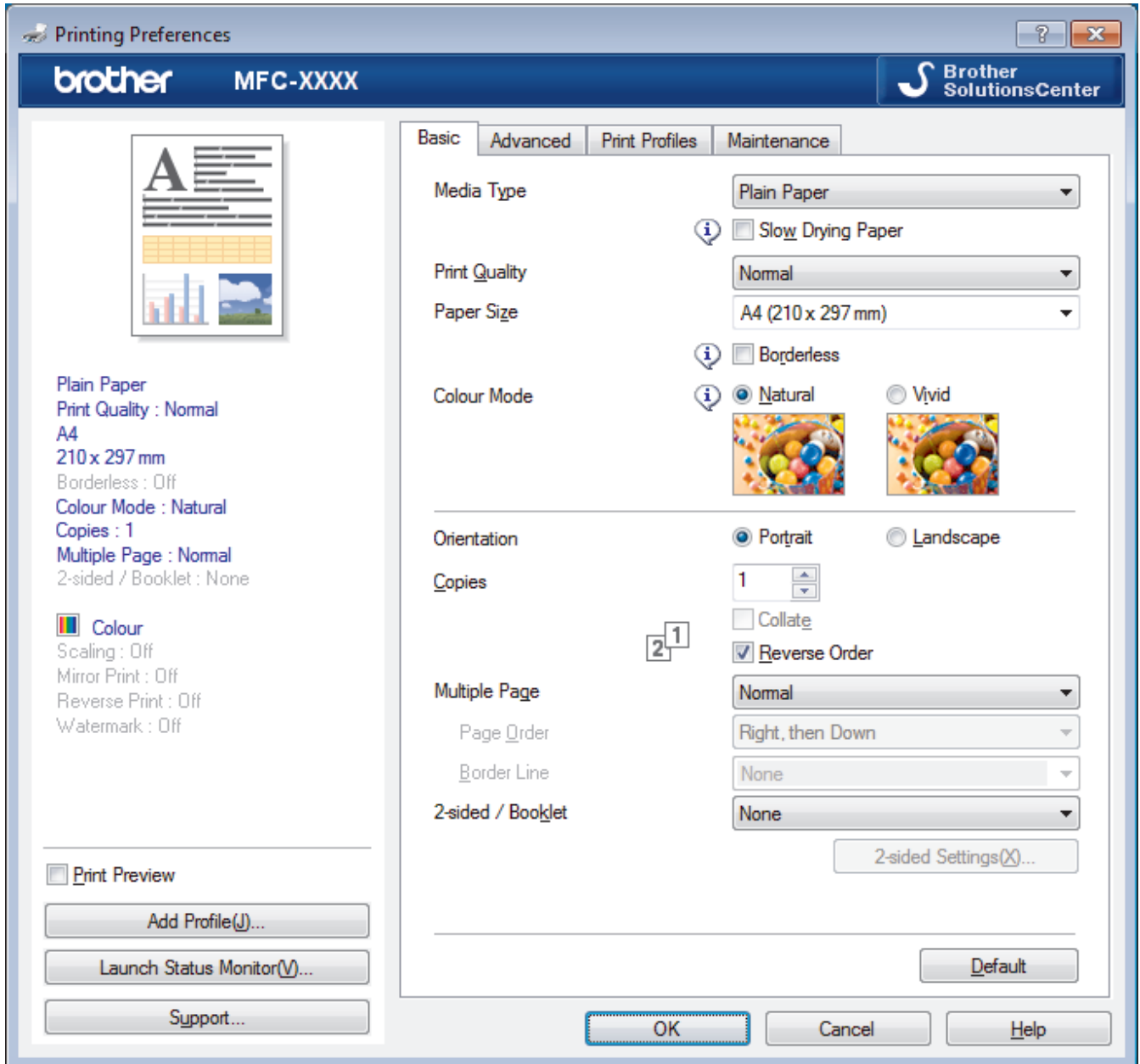

#### 1. Media Type

Select the type of media you want to use. To achieve the best print results, the machine automatically adjusts its print settings according to the selected media type.

#### Slow Drying Paper

Select this option if you use a type of plain paper on which ink dries slowly. This option may cause slight blurring of the text.

#### 2. Print Quality

Select the print resolution you want. Because print quality and speed are related, the higher the quality, the longer it will take to print the document.



---

### 3. Paper Size

Select the size of the paper you want to use. You can either choose from standard paper sizes or create a custom paper size.

#### Borderless

Select this option to print photos without borders. Because the image data is created slightly larger than the paper size you are using, this will cause some cropping of the photo edges.

You may not be able to select the Borderless option for some combinations of media type and quality, or from some applications.

### 4. Colour Mode

Select the colour mode to suit your preference.

### 5. Orientation

Select the orientation (portrait or landscape) of your printout.

If your application contains a similar setting, we recommend that you set the orientation using the application.

### 6. Copies

Type the number of copies (1-999) that you want to print in this field.

#### Collate

Select this option to print sets of multi-page documents in the original page order. When this option is selected, one complete copy of your document will print, and then reprint according to the number of copies you choose. If this option is not selected, then each page will print according to the number of copies chosen before the next page of the document is printed.

#### Reverse Order

Select this option to print your document in reverse order. The last page of your document will be printed first.

### 7. Multiple Page

Select this option to print multiple pages on a single sheet of paper, or print one page of your document on multiple sheets.

#### Page Order

Select the page order when printing multiple pages on a single sheet of paper.

#### Border Line

Select the type of border to use when printing multiple pages on a single sheet of paper.

### 8. 2-sided / Booklet

Select this option to print on both sides of the paper, or print a document in booklet format using 2-sided printing.

#### 2-sided Settings button

Click this button to select the type of 2-sided binding. Four types of 2-sided bindings are available for each orientation.

## Advanced Tab

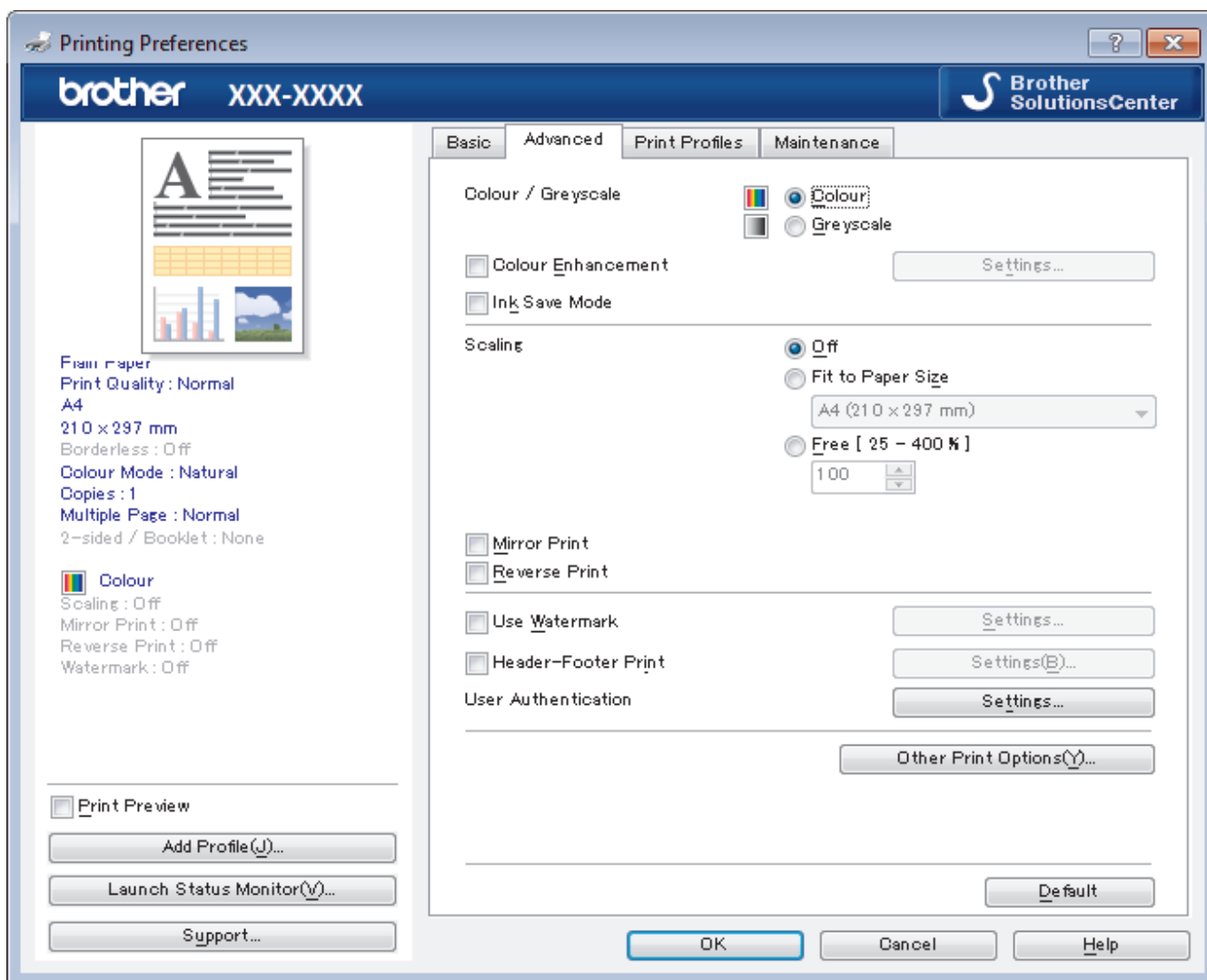

### 1. Colour / Greyscale

Select colour or greyscale printing. The print speed is faster in greyscale mode than it is in colour mode. If your document contains colour and you select greyscale mode, your document will be printed using 256 levels of greyscale.

### 2. Colour Enhancement

Select this option to use the Colour Enhancement feature. This feature analyses your image to improve its sharpness, white balance and colour density. This process may take several minutes depending on the image size and your computer's specifications.

### 3. Ink Save Mode

Select this option to print using lighter colours and emphasise image outlines. The amount of ink that is saved varies, depending on the type of documents printed. Ink Save Mode may make your printouts look different than they appear on your screen.

The Ink Save Mode feature is supported by technology from Reallusion, Inc.



### 4. Scaling

Select these options to enlarge or reduce the size of the pages in your document.

#### Fit to Paper Size

Select this option to enlarge or reduce the document pages to fit a specified paper size. When you select this option, select the paper size you want from the drop-down list.

---

**Free**

Select this option to enlarge or reduce the document pages manually. When you select this option, type a value into the field.

**5. Mirror Print**

Select this option to reverse the printed image on the page horizontally from left to right.

**6. Reverse Print**

Select this option to rotate the printed image 180 degrees.

**7. Use Watermark**

Select this option to print a logo or text on your document as a watermark. Select one of the preset watermarks, add a new watermark, or use an image file you have created.

**8. Header-Footer Print**

Select this option to print the date, time and PC login user name on the document.

**9. User Authentication**

This feature allows you to confirm the restrictions for each user.

**10. Other Print Options button****Change Data Transfer Mode**

Select the print data transfer mode to improve print quality or print speed.

**Advanced Colour Settings**

Select the method that the machine uses to arrange dots to express halftones.

The printout colour can be adjusted to achieve the closest match to what appears on your computer screen.

**Reduce Smudge**

Some types of print media may need more drying time. Change this option if you have problems with smudged printouts or paper jams.

**Retrieve Printer's Colour Data**

Select this option to optimise the print quality using the machine's factory settings, which are set specifically for your Brother machine. Use this option when you have replaced the machine or changed the machine's network address.

**Print Archive**

Select this option to save the print data as a PDF file to your computer.

**Related Information**

- [Print from Your Computer \(Windows\)](#)

**Related Topics:**

- [Error and Maintenance Messages](#)
  - [Paper Handling and Printing Problems](#)
  - [Print a Photo \(Windows\)](#)
  - [Print a Document \(Windows\)](#)
  - [Print More Than One Page on a Single Sheet of Paper \(N in 1\) \(Windows\)](#)
  - [Print as a Poster \(Windows\)](#)
  - [Print on Both Sides of the Paper Automatically \(Automatic 2-sided Printing\) \(Windows\)](#)
  - [Print as a Booklet Automatically \(Windows\)](#)
  - [Use a Preset Print Profile \(Windows\)](#)
  - [Change the Default Print Settings \(Windows\)](#)
  - [Change the Print Setting Options When Having Printing Problems](#)
-

## Print from Your Computer (Mac)

- [Print a Photo \(Mac\)](#)
- [Print a Document \(Mac\)](#)
- [Print on Both Sides of the Paper Automatically \(Automatic 2-sided Printing\) \(Mac\)](#)
- [Print More Than One Page on a Single Sheet of Paper \(N in 1\) \(Mac\)](#)
- [Print a Colour Document in Greyscale \(Mac\)](#)
- [Prevent Smudged Printouts and Paper Jams \(Mac\)](#)
- [Print Options \(Mac\)](#)

## Print a Photo (Mac)



1. Make sure you have loaded the correct media in the paper tray.

### IMPORTANT

- For best results, use Brother paper.
- When you print on Brother photo paper, load one extra sheet of the same photo paper in the paper tray.

2. From an application, such as Apple Preview, click the **File** menu, and then select **Print**.
3. Select **Brother MFC-XXXX** (where XXXX is your model name).



For more page setup options, click the **Show Details** button.

4. Click the **Paper Size** pop-up menu, and then select your paper size.



To print photographs without margins, select a borderless paper size option.

5. Click the **Orientation** button that matches the way you want the photo to print.
6. Click the application pop-up menu, and then select **Print Settings**.  
The **Print Settings** options appear.
7. Click the **Media Type** pop-up menu, and then select the media type you want to use.

### IMPORTANT

To get the best print quality for the settings you have selected, always set the **Media Type** option to match the type of paper you load.

8. Change other printer settings, if needed.
9. Click **Print**.



### Related Information

- [Print from Your Computer \(Mac\)](#)

#### Related Topics:

- [Paper Handling and Printing Problems](#)
- [Print Options \(Mac\)](#)

## Print a Document (Mac)

1. Make sure you have loaded the correct size paper in the paper tray.
2. From an application, such as Apple TextEdit, click the **File** menu, and then select **Print**.
3. Select **Brother MFC-XXXX** (where XXXX is your model name).



For more page setup options, click the **Show Details** button.

4. Click the **Paper Size** pop-up menu, and then select your paper size.
5. Select the **Orientation** option that matches the way you want the document to print.
6. Click the application pop-up menu, and then select **Print Settings**.  
The **Print Settings** options appear.
7. Click the **Media Type** pop-up menu, and then select the media type you want to use.

### IMPORTANT

To get the best print quality for the settings you have selected, always set the **Media Type** option to match the type of paper you load.

8. Change other printer settings, if needed.
9. Click **Print**.



### Related Information

- [Print from Your Computer \(Mac\)](#)

#### Related Topics:

- [Check the Ink Volume \(Page Gauge\)](#)
- [Print Options \(Mac\)](#)

## Print on Both Sides of the Paper Automatically (Automatic 2-sided Printing) (Mac)

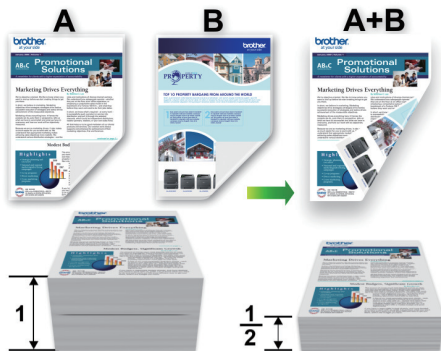

1. From an application, such as Apple TextEdit, click the **File** menu, and then select **Print**.
2. Select **Brother MFC-XXXX** (where XXXX is your model name).



For more page setup options, click the **Show Details** button.

3. Select the **Orientation** option that matches the way you want the document to print.
4. Click the application pop-up menu, and then select **Layout**.  
The **Layout** setting options appear.
5. In the **Two-Sided** section, select the **Short-Edge binding** or **Long-Edge binding** option.
6. Change other printer settings, if needed.



The Borderless feature is not available when using this option.

7. Click **Print**.



### Related Information

- [Print from Your Computer \(Mac\)](#)

### Related Topics:

- [Print Options \(Mac\)](#)

## Print More Than One Page on a Single Sheet of Paper (N in 1) (Mac)



1. From an application, such as Apple TextEdit, click the **File** menu, and then select **Print**.
2. Select **Brother MFC-XXXX** (where XXXX is your model name).



For more page setup options, click the **Show Details** button.

3. Click the application pop-up menu, and then select **Layout**.  
The **Layout** setting options appear.
4. Click the **Pages per Sheet** pop-up menu, and then select the number of pages to print on each sheet.
5. Select the **Layout Direction** option.
6. Click the **Border** pop-up menu, and then select your border line type.
7. Change other printer settings, if needed.
8. Click **Print**.



### Related Information

- [Print from Your Computer \(Mac\)](#)

#### Related Topics:

- [Print Options \(Mac\)](#)



## Print a Colour Document in Greyscale (Mac)

Greyscale mode makes the print processing speed faster than colour mode. If your document contains colour, selecting Greyscale mode prints your document in 256 levels of greyscale.

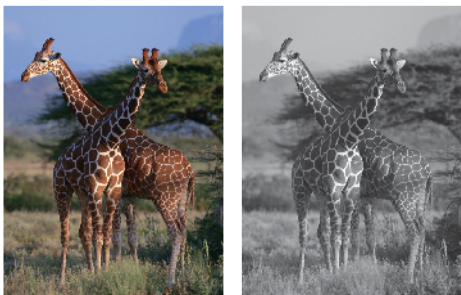

1. From an application, such as Apple TextEdit, click the **File** menu, and then select **Print**.
2. Select **Brother MFC-XXXX** (where XXXX is your model name).



For more page setup options, click the **Show Details** button.

3. Click the application pop-up menu, and then select **Print Settings**.  
The **Print Settings** options appear.
4. Click the **Color / Grayscale** pop-up menu, and then select the **Grayscale** option.
5. Change other printer settings, if needed.
6. Click **Print**.



### Related Information

- [Print from Your Computer \(Mac\)](#)

## Prevent Smudged Printouts and Paper Jams (Mac)

Some types of print media may need more drying time. Change the **Reduce Smudge** option if you have problems with smudged printouts or paper jams.

1. From an application, such as Apple TextEdit, click the **File** menu, and then select **Print**.
2. Select **Brother MFC-XXXX** (where XXXX is your model name).



For more page setup options, click the **Show Details** button.

3. Click the application pop-up menu, and then select **Print Settings**.  
The **Print Settings** options appear.
4. Click the **Advanced** print settings list.
5. Click the **Reduce Smudge** menu.
6. Select one of the following options:

Media Type	Option	Description
Plain Paper	2-sided Printing or Simplex Printing	<b>Off</b> Select this mode to print at normal speed, using a normal amount of ink.
		<b>Low</b> Select this mode to print at a slower speed, using a normal amount of ink.
		<b>High</b> Select this mode to print at the same speed as <b>Low</b> , but using less ink.

7. Change other printer settings, if needed.
8. Click **Print**.



### Related Information

- [Print from Your Computer \(Mac\)](#)

#### Related Topics:

- [Paper Handling and Printing Problems](#)
- [Change the Print Setting Options When Having Printing Problems](#)

## Print Options (Mac)

- >> Page Setup
- >> **Layout**
- >> Paper Handling
- >> **Print Settings**
- >> Color Settings

### Page Setup



Page Attributes

Format For: Brother MFC-XXXX

Brother MFC-XXXX CUPS

Paper Size: A4

210 by 297 mm

Orientation:  

Scale: 100%

?

Cancel OK

#### 1. Paper Size

Select the size of the paper you want to use. You can either choose from standard paper sizes or create a custom paper size.

#### 2. Orientation

Select the orientation (portrait or landscape) of your printout.

If your application contains a similar setting, we recommend that you set the orientation using the application.

#### 3. Scale

Type a value into the field to enlarge or reduce the pages in your document to fit the selected paper size.

## Layout

Printer: Brother MFC-XXXX

Presets: Default Settings

Copies: 1  Two-Sided

Pages:  All  
 From: 1 to: 1

Paper Size: A4 210 by 297 mm

Orientation:

Layout: Layout

Pages per Sheet: 1

Layout Direction:

Border: None

Two-Sided: Off

Reverse page orientation  
 Flip horizontally

? PDF Hide Details Cancel Print

### 1. Pages per Sheet

Select the number of pages to print on a single sheet of paper.

### 2. Layout Direction

Select the page order when printing multiple pages on a single sheet of paper.

### 3. Border

Select the type of border to use when printing multiple pages on a single sheet of paper.

### 4. Two-Sided

Select whether to print on both sides of the paper.

### 5. Reverse page orientation

Select this option to rotate the printed image 180 degrees.

### 6. Flip horizontally

Select this option to reverse the printed image on the page horizontally from left to right.

## Paper Handling

Printer: Brother MFC-XXXX

Presets: Default Settings

Copies: 1  Two-Sided

Pages:  All  
 From: 1 to: 1

Paper Size: A4 210 by 297 mm

Orientation:

Paper Handling

Collate pages

Pages to Print: All pages

Page Order: Automatic

Scale to fit paper size

Destination Paper Size: Suggested Paper: A4

Scale down only

? PDF Hide Details Cancel Print

### 1. Collate pages

Select this option to print sets of multi-page documents in the original page order. When this option is selected, one complete copy of your document will print, and then reprint according to the number of copies you choose. If this option is not selected, then each page will print according to the number of copies chosen before the next page of the document is printed.

### 2. Pages to Print

Select which pages you want to print (even pages or odd pages).

### 3. Page Order

Select the page order.

### 4. Scale to fit paper size

Select this option to enlarge or reduce the pages in your document to fit the selected paper size.

### 5. Destination Paper Size

Select the paper size to print on.

### 6. Scale down only

Select this option if you want to reduce the pages in your document when they are too large for the selected paper size. If this option is selected and the document is formatted for a paper size that is smaller than the paper size you are using, the document will be printed at its original size.

## Print Settings

Printer: Brother MFC-XXXX

Presets: Default Settings

Copies: 1  Two-Sided

Pages:  All  
 From: 1 to: 1

Paper Size: A4 210 by 297 mm

Orientation:  Portrait  Landscape

Print Settings

Media Type: Plain Paper  Slow Drying Paper

Print Quality: Normal

Color / Grayscale: Color

► Advanced

? PDF Hide Details Cancel Print

### 1. Media Type

Select the type of media you want to use. To achieve the best print results, the machine automatically adjusts its print settings according to the selected media type.

### 2. Slow Drying Paper

Select this option if you use a type of plain paper on which ink dries slowly. This option may cause slight blurring of the text.

### 3. Print Quality

Select the print resolution you want. Because print quality and speed are related, the higher the quality, the longer it will take to print the document.

### 4. Color / Grayscale

Select colour or greyscale printing. The print speed is faster in greyscale mode than it is in colour mode. If your document contains colour and you select greyscale mode, your document will be printed using 256 levels of greyscale.

### 5. Advanced

#### Change Data Transfer Mode

Select the print data transfer mode to improve print quality or print speed.

#### Reduce Smudge

Some types of print media may need more drying time. Change this option if you have problems with smudged printouts or paper jams.

#### Other Print Options

##### Paper Thickness

Select the appropriate paper thickness.

##### Bi-Directional Printing

Select this option to increase the print speed. When this option is selected, the print head prints in both directions. When this option is cleared, the print head prints in only one direction, resulting in higher quality printouts but causing slower print speeds.

Sometimes, the movement of the print head may vary due to environmental conditions. This may be seen when you print vertical lines and they do not align. If you encounter this problem, turn off the Bi-Directional Printing feature.

## Color Settings

Printer: Brother MFC-XXXX

Presets: Default Settings

Copies: 1  Two-Sided

Pages:  All  
 From: 1 to: 1

Paper Size: A4 210 by 297 mm

Orientation:

Color Settings

Color Mode:  Natural  
 Vivid  
 None

Advanced Color Settings

Color Enhancement

Brightness 0

Contrast 0

Red 0

Green 0

Blue 0

Halftone Pattern: Diffusion

PDF Hide Details Cancel Print

### 1. Color Mode

Select the colour mode to suit your preference.

### 2. Advanced Color Settings

Click the disclosure triangle to view the Advanced Colour Settings. Select the Colour Enhancement check box, and then set the options using the sliders. This process may take several minutes depending on the size of the image and the specifications of your computer.

## ✓ Related Information

- [Print from Your Computer \(Mac\)](#)

### Related Topics:

- [Error and Maintenance Messages](#)
- [Paper Handling and Printing Problems](#)
- [Print a Photo \(Mac\)](#)
- [Print a Document \(Mac\)](#)
- [Print on Both Sides of the Paper Automatically \(Automatic 2-sided Printing\) \(Mac\)](#)
- [Print More Than One Page on a Single Sheet of Paper \(N in 1\) \(Mac\)](#)

- 
- Change the Print Setting Options When Having Printing Problems
-



## Scan

- [Scan Using the Scan Button on Your Brother Machine](#)
- [Scan from Your Computer \(Windows\)](#)
- [Scan from Your Computer \(Mac\)](#)
- [Configure Scan Settings Using Web Based Management](#)

## Scan Using the Scan Button on Your Brother Machine

- [Scan Photos and Graphics](#)
- [Save Scanned Data to a Folder as a PDF File](#)
- [Save Scanned Data to a Memory Card or USB Flash Drive](#)
- [Scan Multiple Business Cards and Photos \(Auto Crop\)](#)
- [Scan to an Editable Text File Using OCR](#)
- [Scan to Email Attachment](#)
- [Scan to FTP](#)
- [Scan to SSH FTP \(SFTP\)](#)
- [Scan to Network \(Windows\)](#)
- [Scan to SharePoint](#)
- [Web Services for Scanning on Your Network \(Windows 7, Windows 8 and Windows 10\)](#)
- [Change Scan Button Settings from ControlCenter4 \(Windows\)](#)
- [Change Scan Button Settings from Brother iPrint&Scan \(Mac\)](#)

## Scan Photos and Graphics

Send scanned photos or graphics directly to your computer.

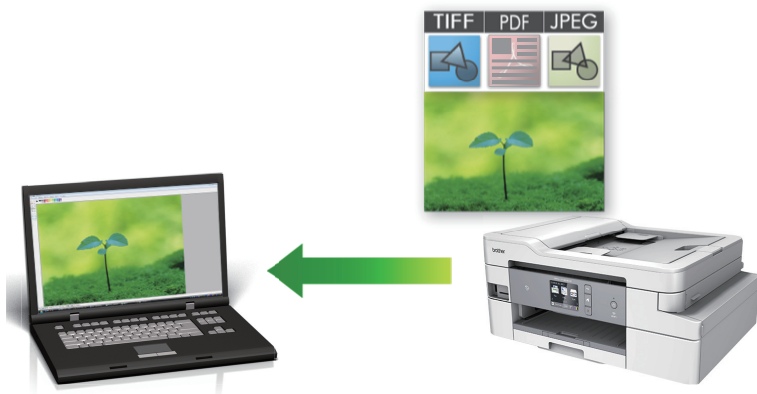

Use the Scan button on the machine to make temporary changes to the scan settings. To make permanent changes, use either ControlCenter4 (Windows) or Brother iPrint&Scan (Mac) software.

1. Load your document.
2. Press [Scan] > [to PC] > [to Image].
3. If the machine is connected over the network, press ▲ or ▼ to display the computer where you want to send data, and then press the computer name.



If the LCD prompts you to enter a PIN, use the LCD to enter the four-digit PIN for the computer, and then press [OK].

4. Do one of the following:
  - To change the settings, press [Options] or [Set at Device].
  - Press [Start] to start scanning without changing additional settings.

The machine starts scanning. If using the machine's scanner glass, follow the LCD instructions to complete the scanning job.



To use the [Options] or [Set at Device] setting, a computer with either ControlCenter4 (Windows) or Brother iPrint&Scan (Mac) software installed must be connected to the machine.

5. Select the scan settings you want to change, and then press [OK].

Option	Description
Scan Type	Select the scan type for your document.
Resolution	Select the scan resolution for your document.
File Type	Select the file format for your document.
Document Size	Select your document size.
Brightness	Select the brightness level.
Contrast	Select the contrast level.
ADF Auto Deskew (Available only for certain models)	Correct any skewed documents when they are scanned using the ADF.
Skip Blank Page	When On is selected, blank pages are skipped.

---

Option	Description
Remove Background Colour	Change the amount of background colour that is removed.



- To save the settings as a shortcut, press [Save as Shortcut]. You will be asked if you want to make this a One Touch Shortcut. Follow the LCD instructions.
- 

6. Press [Start].

The machine starts scanning. If using the machine's scanner glass, follow the LCD instructions to complete the scanning job.



### Related Information

- [Scan Using the Scan Button on Your Brother Machine](#)
-

## Save Scanned Data to a Folder as a PDF File

Scan documents and save them to a folder on your computer as PDF files.



Use the Scan button on the machine to make temporary changes to the scan settings. To make permanent changes, use either ControlCenter4 (Windows) or Brother iPrint&Scan (Mac) software.

1. Load your document.
2. Press [Scan] > [to PC] > [to File].
3. If the machine is connected over the network, press ▲ or ▼ to display the computer where you want to send data, and then press the computer name.



If the LCD prompts you to enter a PIN, use the LCD to enter the four-digit PIN for the computer, and then press [OK].

4. Do one of the following:
  - To change the settings, press [Options] or [Set at Device].
  - Press [Start] to start scanning without changing additional settings.

The machine starts scanning. If using the machine's scanner glass, follow the LCD instructions to complete the scanning job.



To use the [Options] or [Set at Device] setting, a computer with either ControlCenter4 (Windows) or Brother iPrint&Scan (Mac) software installed must be connected to the machine.

5. Select the scan settings you want to change, and then press [OK].

Option	Description
Scan Type	Select the scan type for your document.
Resolution	Select the scan resolution for your document.
File Type	Select the file format for your document.
Document Size	Select your document size.
Brightness	Select the brightness level.
Contrast	Select the contrast level.
ADF Auto Deskew (Available only for certain models)	Correct any skewed documents when they are scanned using the ADF.

---

Option	Description
Skip Blank Page	When On is selected, blank pages are skipped.
Remove Background Colour	Change the amount of background colour that is removed.

---



- To save the settings as a shortcut, press [Save as Shortcut]. You will be asked if you want to make this a One Touch Shortcut. Follow the LCD instructions.
- 

6. Press [Start].

The machine starts scanning. If using the machine's scanner glass, follow the LCD instructions to complete the scanning job.



### Related Information

- [Scan Using the Scan Button on Your Brother Machine](#)
-

## Save Scanned Data to a Memory Card or USB Flash Drive

Scan documents and save them directly to a memory card or USB flash drive without using a computer.

1. Load your document.
2. Insert a memory card or USB flash drive into your machine.  
The LCD screen automatically changes.
3. Press [Scan to Media].
4. Do one of the following:
  - To change the settings, press [Options], and then go to the next step.



- To set your own default settings: after making changes to settings, press the [Set New Default] option, and then press [Yes].
- To restore the factory settings: press the [Factory Reset] option, and then press [Yes].

- Press [Start] to start scanning without changing additional settings.

The machine starts scanning. If using the machine's scanner glass, follow the LCD instructions to complete the scanning job.

5. Select the scan settings you want to change, and then press [OK].

Option	Description
Scan Type	Select the scan type for your document.
Resolution	Select the scan resolution for your document.
File Type	Select the file format for your document.
Document Size	Select your document size.
Scan Long Paper (ADF)	Scan a long document using the ADF.
File Name	Rename the file.
File Name Style	Select the order in which the date, counter number, and other items appear in the file names.
Brightness	Select the brightness level.
Contrast	Select the contrast level.
Auto Crop	Scan multiple documents placed on the scanner glass to a memory card or USB flash drive. The machine will scan each document and create separate files or a single multi-page file.
ADF Auto Deskew (Available only for certain models)	Correct any skewed documents when they are scanned using the ADF.
Skip Blank Page	When On is selected, blank pages are skipped.
Skip Blank Page Sensitivity	Select the sensitivity level for detecting blank pages in the scanned data. The higher the sensitivity, the easier it is for the machine to detect blank pages.
Remove Background Colour	Change the amount of background colour that is removed.



- To save the settings as a shortcut, press [Save as Shortcut]. You will be asked if you want to make this a One Touch Shortcut. Follow the LCD instructions.

6. Press [Start].
7. If you are using the scanner glass, set the next page and then press [Continue]. If there are no more pages to scan, press [Finish]. After you finish scanning, make sure you choose [Finish] before removing the memory card or USB flash drive from the machine.

## IMPORTANT

The LCD displays a message while reading the data. DO NOT unplug the power cord or remove the memory card or USB flash drive from the machine while it is reading the data. You could lose your data or damage the memory card or USB flash drive.



## Related Information

- [Scan Using the Scan Button on Your Brother Machine](#)
  - [Compatible Media](#)







## Compatible Media

Your Brother machine has media drives (slots) for use with common data storage and digital camera media.

### IMPORTANT

The USB direct interface supports only USB flash drives and digital cameras that use the USB mass storage standard. Other USB devices are not supported.

Compatible Media	
USB flash drive	
SD Memory Card SDHC Memory Card SDXC Memory Card MultiMediaCard MultiMediaCard plus	  
miniSD (Adapter required) miniSDHC (Adapter required) microSD (Adapter required) microSDHC (Adapter required) MultiMediaCard mobile (Adapter required)	



### Related Information

- [Save Scanned Data to a Memory Card or USB Flash Drive](#)
- [Print Photos Directly from Media](#)

## Scan Multiple Business Cards and Photos (Auto Crop)

You can scan multiple documents placed on the scanner glass. The machine will scan each document and use the Auto Crop feature to create separate files or a single multi-page file.

### Guidelines for Auto Crop

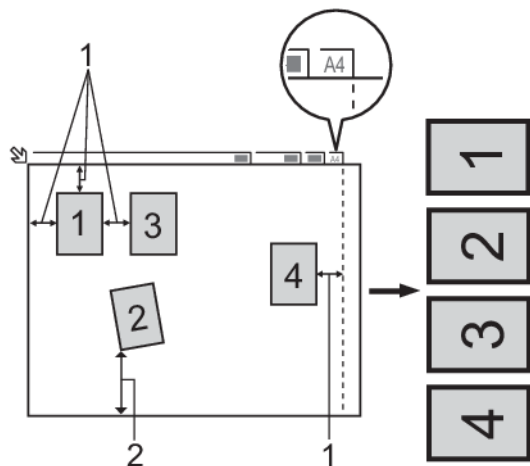

1. 10 mm or greater
2. 20 mm or greater (bottom)
  - This setting is available only for documents that are rectangular or square.
  - If your document is too long or wide, this feature will not work as described here.
  - You must place the documents away from the edges of the scanner glass as shown in the illustration.
  - You must place the documents at least 10 mm away from each other.
  - Auto Crop adjusts the skew of the document on the scanner glass; however, if your document is skewed more than 45 degrees at less than 300 x 300 dpi or 10 degrees at 600 x 600 dpi, this feature will not work.
  - The ADF must be empty to use Auto Crop.
  - The Auto Crop feature is available for a maximum of 16 documents, depending on the size of the documents.

1. Load documents on the scanner glass.



- To scan documents using the Auto Crop feature, you must put the documents on the scanner glass.
- The Auto Crop feature is supported by technology from Reallusion, Inc.



2. Insert a memory card or USB flash drive into your machine.

The LCD screen automatically changes.

3. Press [Scan to Media] > [Options] > [Auto Crop].
4. Press [On].
5. Press [OK].
6. Press [Start].

The machine starts scanning. Follow the LCD instructions to complete the scanning job.



### Related Information

- [Scan Using the Scan Button on Your Brother Machine](#)

## Scan to an Editable Text File Using OCR

Your machine can convert characters in a scanned document to text using optical character recognition (OCR) technology. You can edit this text using your preferred text-editing application.



- The Scan to OCR feature is available for certain languages.
- Use the Scan button on the machine to make temporary changes to the scan settings. To make permanent changes, use either ControlCenter4 (Windows) or Brother iPrint&Scan (Mac) software.

1. Load your document.
2. Press [Scan] > [to PC] > [to OCR].
3. If the machine is connected over the network, press ▲ or ▼ to display the computer where you want to send data, and then press the computer name.

 If the LCD prompts you to enter a PIN, use the LCD to enter the four-digit PIN for the computer, and then press [OK].

4. Do one of the following:
  - To change the settings, press [Options] or [Set at Device].
  - Press [Start] to start scanning without changing additional settings.The machine starts scanning. If using the machine's scanner glass, follow the LCD instructions to complete the scanning job.

 To use the [Options] or [Set at Device] setting, a computer with either ControlCenter4 (Windows) or Brother iPrint&Scan (Mac) software installed must be connected to the machine.

5. Select the scan settings you want to change, and then press [OK].

Option	Description
Scan Type	Select the scan type for your document.
Resolution	Select the scan resolution for your document.
File Type	Select the file format for your document.
Document Size	Select your document size.
Brightness	Select the brightness level.
Contrast	Select the contrast level.
ADF Auto Des skew	Correct any skewed documents when they are scanned using the ADF.

---

Option	Description
(Available only for certain models)	
Skip Blank Page	When On is selected, blank pages are skipped.
Remove Background Colour	Change the amount of background colour that is removed.

---



- To save the settings as a shortcut, press [Save as Shortcut]. You will be asked if you want to make this a One Touch Shortcut. Follow the LCD instructions.
- 

6. Press [Start].

The machine starts scanning. If using the machine's scanner glass, follow the LCD instructions to complete the scanning job.



### Related Information

- [Scan Using the Scan Button on Your Brother Machine](#)
-

## Scan to Email Attachment

Send a scanned document as an email attachment.

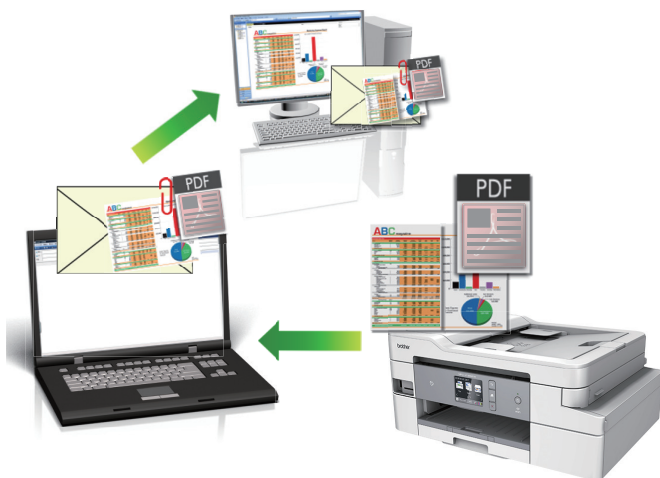

- Use the Scan button on the machine to make temporary changes to the scan settings. To make permanent changes, use either ControlCenter4 (Windows) or Brother iPrint&Scan (Mac) software.
- The Scan to Email feature does not support Webmail services. Use the Scan to Image or Scan to File feature to scan a document or a picture, and then attach the scanned file to an email message.

1. Load your document.
2. Press [Scan] > [to PC] > [to E-mail].
3. If the machine is connected over the network, press ▲ or ▼ to display the computer where you want to send data, and then press the computer name.

 If the LCD prompts you to enter a PIN, use the LCD to enter the four-digit PIN for the computer, and then press [OK].

4. Do one of the following:
  - To change the settings, press [Options] or [Set at Device].
  - Press [Start] to start scanning without changing additional settings.The machine scans the document and saves it as a file attachment. It then launches your email application and opens a new, blank email message with the scanned file attached.

 To use the [Options] or [Set at Device] setting, a computer with either ControlCenter4 (Windows) or Brother iPrint&Scan (Mac) software installed must be connected to the machine.

5. Select the scan settings you want to change, and then press [OK].

Option	Description
Scan Type	Select the scan type for your document.
Resolution	Select the scan resolution for your document.
File Type	Select the file format for your document.
Document Size	Select your document size.
Brightness	Select the brightness level.

---

Option	Description
Contrast	Select the contrast level.
ADF Auto Deskew (Available only for certain models)	Correct any skewed documents when they are scanned using the ADF.
Skip Blank Page	When On is selected, blank pages are skipped.
Remove Background Colour	Change the amount of background colour that is removed.



- To save the settings as a shortcut, press [Save as Shortcut]. You will be asked if you want to make this a One Touch Shortcut. Follow the LCD instructions.

6. Press [Start].

The machine scans the document and saves it as a file attachment. It then launches your email application and opens a new, blank email message with the scanned file attached.



### Related Information

- [Scan Using the Scan Button on Your Brother Machine](#)
-

## Scan to FTP

Scan documents directly to an FTP server when you need to share the scanned information. For added convenience, configure different profiles to save your favourite Scan to FTP destinations.

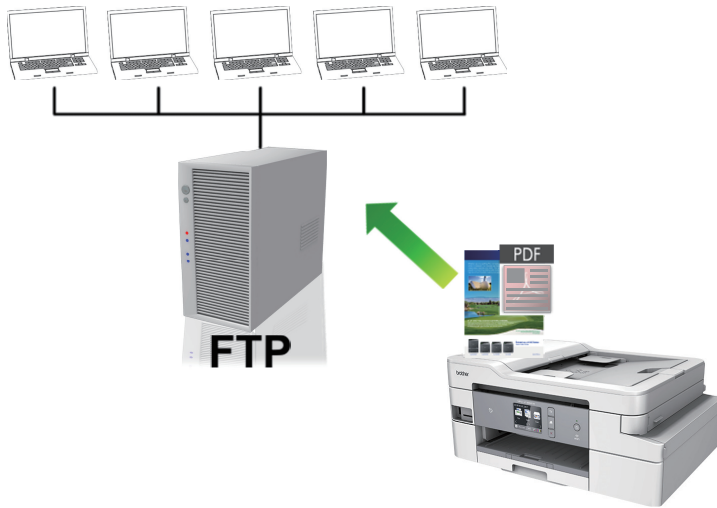

- [Set up a Scan to FTP Profile](#)
- [Upload Scanned Data to an FTP Server](#)

## Set up a Scan to FTP Profile

Set up a Scan to FTP Profile to scan and upload the scanned data directly to an FTP location.

We recommend Microsoft Internet Explorer 11/Microsoft Edge for Windows, and Safari 10/11 for Mac. Make sure that JavaScript and Cookies are always enabled in whichever browser you use.

1. Start your web browser.

Type "https://machine's IP address" in your browser's address bar (where "machine's IP address" is the IP address of the machine or the print server name). For example: https://192.168.1.2

If the machine prompts you for a password, type it, and then click .

2. Click the **Scan** tab.
3. Click the **Scan to FTP/SFTP/Network/SharePoint** menu in the left navigation bar.
4. Select the **FTP** option, and then click **Submit**.

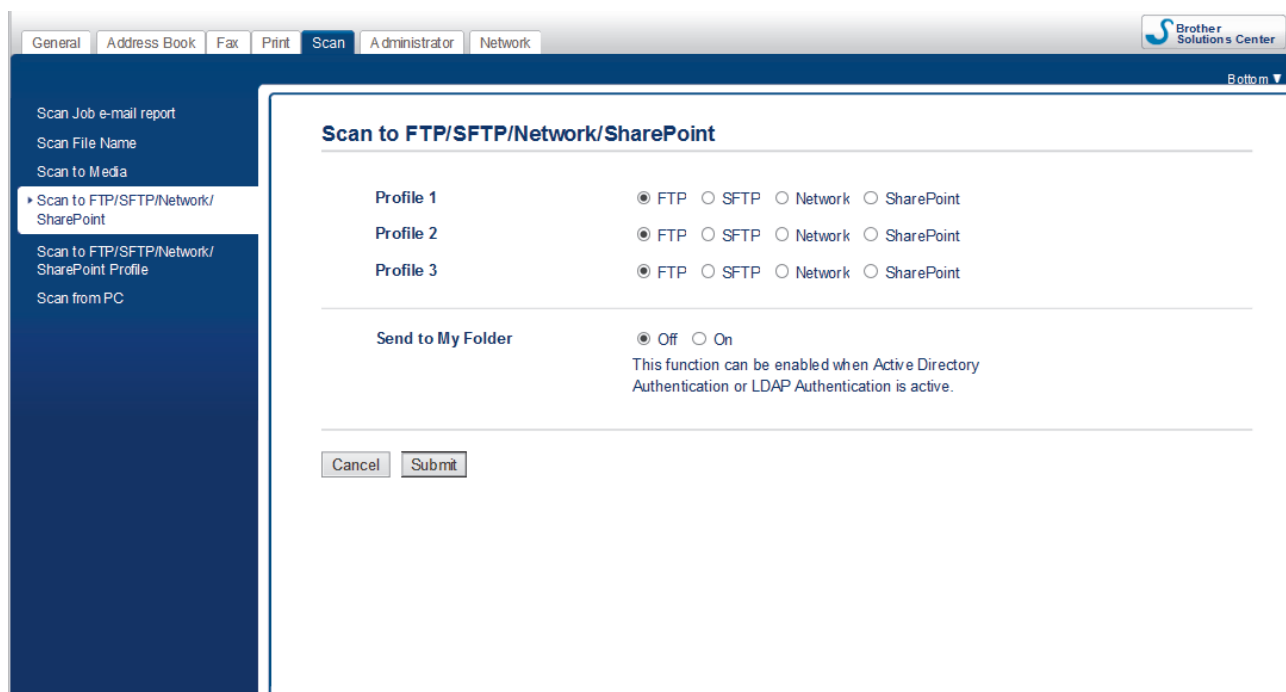

5. Click the **Scan to FTP/SFTP/Network/SharePoint Profile** menu in the left navigation bar.
6. Select the profile you want to set up or change.



Using the following characters: ?, /, \, ", :, <, >, | or \* may cause a sending error.

Option	Description
<b>Profile Name</b>	Type a name for this server profile (up to 15 alphanumeric characters). The machine will display this name on the LCD.
<b>Host Address</b>	Type the Host Address (for example: ftp.example.com; up to 64 characters) or the IP address (for example: 192.23.56.189).
<b>Port Number</b>	Change the <b>Port Number</b> setting used to access the FTP server. The default for this setting is port 21. In most cases this setting does not need to be changed.
<b>Username</b>	Type a user name (up to 32 characters) that has permission to write data to the FTP server.



Option	Description
<b>Password</b>	Type the password (up to 32 characters) associated with the user name you entered in the <b>Username</b> field. Type the password again in the <b>Retype password</b> field.
<b>SSL/TLS</b>	Set the <b>SSL/TLS</b> option to scan securely using SSL/TLS communication. Change the <b>CA Certificate</b> setting, if needed.
<b>Store Directory</b>	Type the path (up to 60 characters) to the folder on the FTP server where you want to send your scanned data. Do not type a slash mark at the beginning of the path (for example: brother/abc).
<b>File Name</b>	Select a file name from the preset names provided, or from user-defined names. You can set the user-defined names and file name style in the <b>Scan File Name</b> menu in the left navigation bar.
<b>Quality</b>	Select a quality setting. If you choose the <b>User Select</b> option, the machine will prompt users to select a setting each time they use the scan profile.
<b>File Type</b>	Select the file type you want to use for the scanned document. If you choose the <b>User Select</b> option, the machine will prompt users to select a setting each time they use the scan profile.
<b>Document Size</b>	Select your document size from the list. This is necessary to make sure the scanned file is the correct size.
<b>Scan Long Paper (ADF)</b>	Select the <b>On</b> option to scan a document printed on long paper using the ADF.
<b>ADF Auto Deskew</b>	Select <b>Auto</b> to set the machine to correct document skewing automatically as the pages are scanned from the ADF.
<b>Skip Blank Page</b>	Select the <b>On</b> option to remove blank pages of the document from the scanning results.
<b>Skip Blank Page Sensitivity</b>	Select the sensitivity level for detecting blank pages in the scanned data. The higher the sensitivity, the easier it is for the machine to detect blank pages.
<b>Remove Background Color</b>	Change the amount of background colour that is removed.
<b>Brightness</b>	Select the brightness level.
<b>Contrast</b>	Select the contrast level.
<b>Passive Mode</b>	Set the <b>Passive Mode</b> option to off or on depending on your FTP server and network firewall configuration. The default setting is on. In most cases this setting does not need to be changed.

7. Click **Submit**.



## Related Information

- [Scan to FTP](#)

## Upload Scanned Data to an FTP Server

1. Load your document.
2. Press [Scan] > [to FTP/SFTP].
3. The server profiles you have set up using Web Based Management are listed. Select the profile you want. If the profile is not complete (for example, if the logon account name and password are missing, or if the quality or file type is not specified), you will be prompted to enter any missing information.
4. Press [Start].

The machine starts scanning. If you are using the scanner glass, follow the Touchscreen instructions to complete the scanning job.



### Related Information

- [Scan to FTP](#)

## Scan to SSH FTP (SFTP)

Scan documents directly to an SFTP server, a secure version of an FTP server. For added convenience, configure different profiles to save your favourite Scan to SFTP destinations.

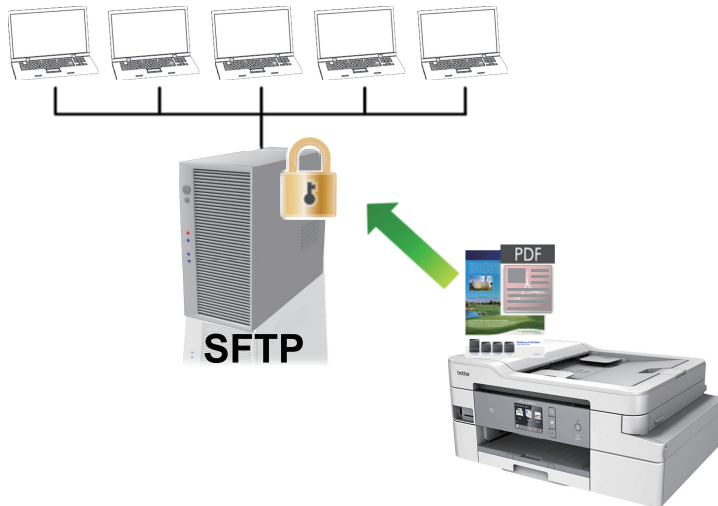

- Set up a Scan to SFTP Profile
- Create a Client Key Pair Using Web Based Management
- Export a Client Key Pair Using Web Based Management
- Import a Server Public Key Using Web Based Management
- Upload Scanned Data to an SFTP Server

## Set up a Scan to SFTP Profile

Set up a Scan to SFTP Profile to scan and upload scanned data directly to an SFTP location.

We recommend Microsoft Internet Explorer 11/Microsoft Edge for Windows, and Safari 10/11 for Mac. Make sure that JavaScript and Cookies are always enabled in whichever browser you use.

1. Start your web browser.  
Type "https://machine's IP address" in your browser's address bar (where "machine's IP address" is the IP address of the machine or the print server name). For example: https://192.168.1.2  
If the machine prompts you for a password, type it, and then click .
2. Click the **Scan** tab.
3. Click the **Scan to FTP/SFTP/Network/SharePoint** menu in the left navigation bar.
4. Select the **SFTP** option, and then click **Submit**.

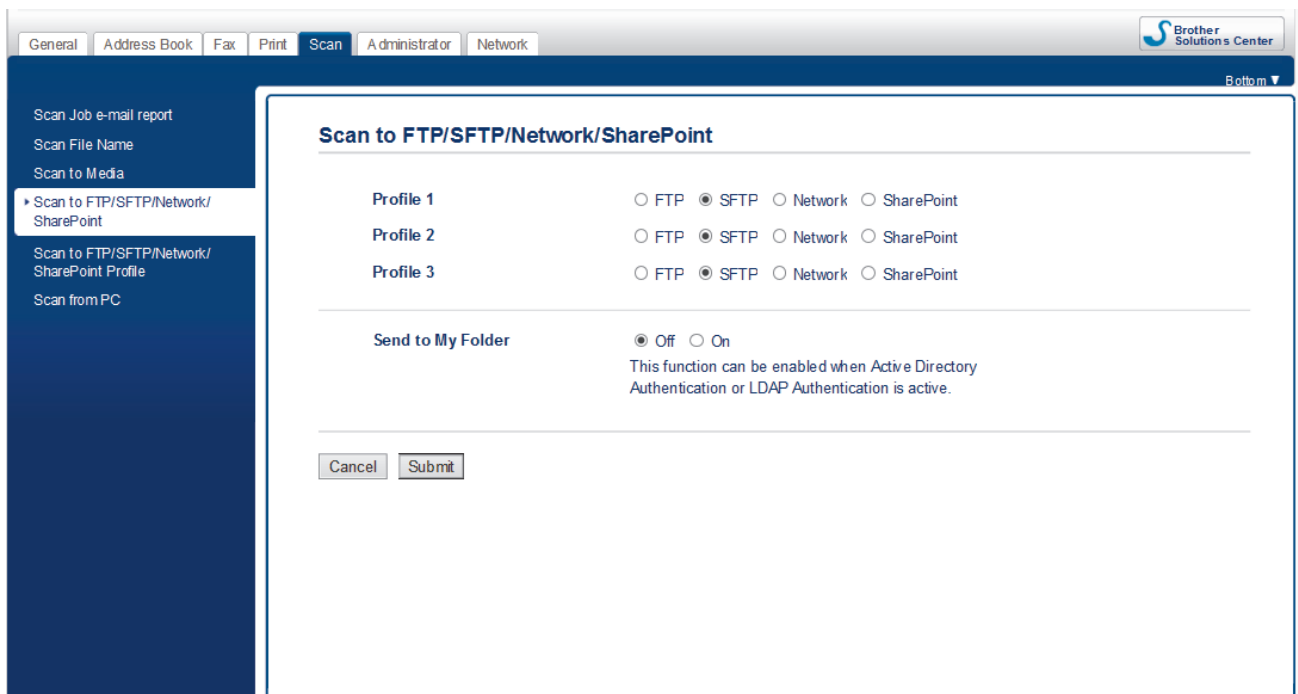

5. Click the **Scan to FTP/SFTP/Network/SharePoint Profile** menu in the left navigation bar.
6. Select the profile you want to set up or change.



Using the following characters: ?, /, \, ", :, <, >, | or \* may cause a sending error.

Option	Description
<b>Profile Name</b>	Type a name for this server profile (up to 15 alphanumeric characters). The machine will display this name on the LCD.
<b>Host Address</b>	Type the Host Address (for example: ftp.example.com; up to 64 characters) or the IP address (for example: 192.23.56.189).
<b>Username</b>	Type a user name (up to 32 characters) that has permission to write data to the FTP server.
<b>Auth. Method</b>	Select <b>Password</b> or <b>Public Key</b> . Do one of the following: <ul style="list-style-type: none"> <li>• When you select <b>Password</b>, type the password (up to 32 characters) associated with the user name you typed in the</li> </ul>

Option	Description
	<p><b>Username</b> field. Type the password again in the <b>Retype password</b> field.</p> <ul style="list-style-type: none"> <li>When you select <b>Public Key</b>, select the authentication type from the <b>Client Key Pair</b> drop-down list.</li> </ul>
<b>Server Public Key</b>	Select the authentication type.
<b>Store Directory</b>	Type the path (up to 60 characters) to the folder on the FTP server where you want to send your scanned data. Do not type a slash mark at the beginning of the path (for example: brother/abc).
<b>File Name</b>	Select a file name from the preset names provided, or from user-defined names. You can set the user-defined names and file name style in the <b>Scan File Name</b> menu in the left navigation bar.
<b>Quality</b>	Select a quality setting. If you choose the <b>User Select</b> option, the machine will prompt users to select a setting each time they use the scan profile.
<b>File Type</b>	Select the file type you want to use for the scanned document. If you choose the <b>User Select</b> option, the machine will prompt users to select a setting each time they use the scan profile.
<b>Document Size</b>	Select your document size from the list. This is necessary to make sure the scanned file is the correct size.
<b>Scan Long Paper (ADF)</b>	Select the <b>On</b> option to scan a document printed on long paper using the ADF.
<b>ADF Auto Deskew</b>	Select <b>Auto</b> to set the machine to correct document skewing automatically as the pages are scanned from the ADF.
<b>Skip Blank Page</b>	Select the <b>On</b> option to remove blank pages of the document from the scanning results.
<b>Skip Blank Page Sensitivity</b>	Select the sensitivity level for detecting blank pages in the scanned data. The higher the sensitivity, the easier it is for the machine to detect blank pages.
<b>Remove Background Color</b>	Change the amount of background colour that is removed.
<b>Brightness</b>	Select the brightness level.
<b>Contrast</b>	Select the contrast level.
<b>Port Number</b>	Change the <b>Port Number</b> setting used to access the FTP server. The default for this setting is port 22. In most cases this setting does not need to be changed.

7. Click **Submit**.



## Related Information

- [Scan to SSH FTP \(SFTP\)](#)

## Create a Client Key Pair Using Web Based Management

1. Start your web browser.
2. Type "https://machine's IP address" in your browser's address bar (where "machine's IP address" is the machine's IP address).

For example:

https://192.168.1.2



- If you are using a Domain Name System or enable a NetBIOS name, you can type another name, such as "SharedPrinter" instead of the IP address.

- For example:

https://SharedPrinter

If you enable a NetBIOS name, you can also use the node name.

- For example:

https://brnxxxxxxxxxxxx

The NetBIOS name can be found in the Network Configuration Report.

- For Mac, access Web Based Management by clicking the machine's icon on the **Status Monitor** screen.

3. If the machine prompts you for a password, type it, and then click .
4. Click the **Network** tab.
5. Click the **Security** tab.
6. Click **Client Key Pair** in the left navigation bar.
7. Click **Create New Client Key Pair**.
8. In the **Client Key Pair Name** field, type the name (up to 20 characters) you want.
9. Click the **Public Key Algorithm** drop-down list, and then select the algorithm you want.
10. Click **Submit**.

The client key pair is created and saved in your machine's memory. The client key pair name and public key algorithm will be displayed in the **Client Key Pair List**.



### Related Information

- [Scan to SSH FTP \(SFTP\)](#)

## Export a Client Key Pair Using Web Based Management

1. Start your web browser.
2. Type "https://machine's IP address" in your browser's address bar (where "machine's IP address" is the machine's IP address).

For example:

https://192.168.1.2



- If you are using a Domain Name System or enable a NetBIOS name, you can type another name, such as "SharedPrinter" instead of the IP address.

- For example:

https://SharedPrinter

If you enable a NetBIOS name, you can also use the node name.

- For example:

https://brnxxxxxxxxxxxx

The NetBIOS name can be found in the Network Configuration Report.

- For Mac, access Web Based Management by clicking the machine's icon on the **Status Monitor** screen.

3. If the machine prompts you for a password, type it, and then click .
4. Click the **Network** tab.
5. Click the **Security** tab.
6. Click **Client Key Pair** in the left navigation bar.
7. Click **Export Public Key** shown with **Client Key Pair List**.
8. Click **Submit**.
9. Specify the location where you want to save the file.

The client key pair is exported to your computer.



### Related Information

- [Scan to SSH FTP \(SFTP\)](#)

## Import a Server Public Key Using Web Based Management

1. Start your web browser.
2. Type "https://machine's IP address" in your browser's address bar (where "machine's IP address" is the machine's IP address).

For example:

https://192.168.1.2



- If you are using a Domain Name System or enable a NetBIOS name, you can type another name, such as "SharedPrinter" instead of the IP address.

- For example:

https://SharedPrinter

If you enable a NetBIOS name, you can also use the node name.

- For example:

https://brnxxxxxxxxxxxx

The NetBIOS name can be found in the Network Configuration Report.

- For Mac, access Web Based Management by clicking the machine's icon on the **Status Monitor** screen.

3. If the machine prompts you for a password, type it, and then click .
4. Click the **Network** tab.
5. Click the **Security** tab.
6. Click **Server Public Key** in the left navigation bar.
7. Click **Import Server Public Key**.
8. Specify the file that you want to import.
9. Click **Submit**.

The server public key is imported to your machine.



### Related Information

- [Scan to SSH FTP \(SFTP\)](#)



## Upload Scanned Data to an SFTP Server

1. Load your document.
2. Press [Scan] > [to FTP/SFTP].
3. The server profiles you have set up using Web Based Management are listed. Select the profile you want. If the profile is not complete (for example, if the logon account name and password are missing, or if the quality or file type is not specified), you will be prompted to enter any missing information.
4. Press [Start].

The machine starts scanning. If you are using the scanner glass, follow the Touchscreen instructions to complete the scanning job.



### Related Information

- [Scan to SSH FTP \(SFTP\)](#)

## Scan to Network (Windows)

Scan documents directly to a CIFS server on your local network. For added convenience, you can configure different profiles to save your favourite Scan to Network destinations.

- [Set up a Scan to Network Profile](#)
- [Upload Scanned Data to a CIFS Server](#)

## Set up a Scan to Network Profile

Set up a Scan to Network Profile to scan and upload scanned data directly to a folder on a CIFS server.

We recommend Microsoft Internet Explorer 11/Microsoft Edge for Windows, and Safari 10/11 for Mac. Make sure that JavaScript and Cookies are always enabled in whichever browser you use.

1. Start your web browser.  
Type "https://machine's IP address" in your browser's address bar (where "machine's IP address" is the IP address of the machine or the print server name). For example: https://192.168.1.2  
  
If the machine prompts you for a password, type it, and then click .
2. Click the **Scan** tab.
3. Click the **Scan to FTP/SFTP/Network/SharePoint** menu in the left navigation bar.
4. Select the **Network** option, and then click **Submit**.

 If you want to send the data to your designated folder on the CIFS server, select **On** for the **Send to My Folder** option.

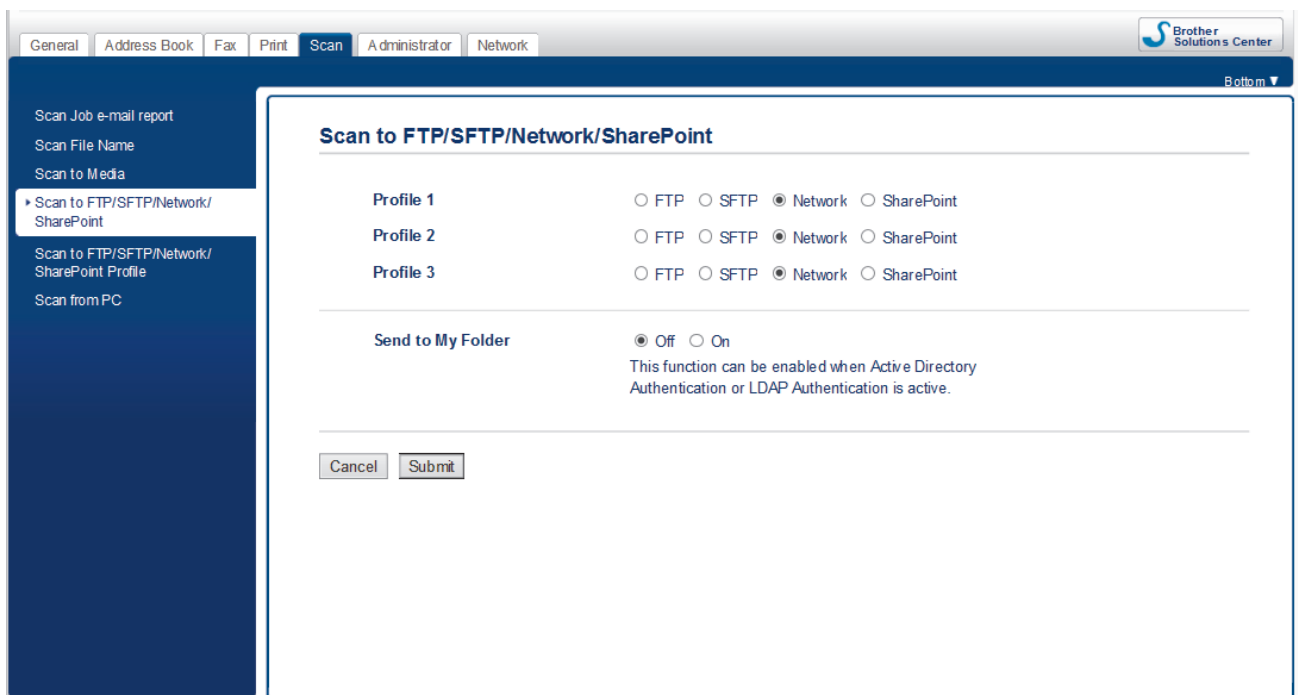

5. Click the **Scan to FTP/SFTP/Network/SharePoint Profile** menu in the left navigation bar.
6. Select the profile you want to set up or change.

 Using the following characters: ?, /, \, ", :, <, >, | or \* may cause a sending error.

Option	Description
<b>Profile Name</b>	Type a name for this server profile (up to 15 alphanumeric characters). The machine will display this name on the LCD.
<b>Network Folder Path</b>	Type the path to the folder on the CIFS server where you want to send your scanned data.
<b>File Name</b>	Select a file name from the preset names provided, or from user-defined names. You can set the user-defined names and file name style in the <b>Scan File Name</b> menu in the left navigation bar.

Option	Description
<b>Quality</b>	Select a quality setting. If you choose the <b>User Select</b> option, the machine will prompt users to select a setting each time they use the scan profile.
<b>File Type</b>	Select the file type you want to use for the scanned document. If you choose the <b>User Select</b> option, the machine will prompt users to select a setting each time they use the scan profile.
<b>Document Size</b>	Select your document size from the list. This is necessary to make sure the scanned file is the correct size.
<b>Scan Long Paper (ADF)</b>	Select the <b>On</b> option to scan a document printed on long paper using the ADF.
<b>ADF Auto Deskew</b>	Select <b>Auto</b> to set the machine to correct document skewing automatically as the pages are scanned from the ADF.
<b>Skip Blank Page</b>	Select the <b>On</b> option to remove blank pages of the document from the scanning results.
<b>Skip Blank Page Sensitivity</b>	Select the sensitivity level for detecting blank pages in the scanned data. The higher the sensitivity, the easier it is for the machine to detect blank pages.
<b>Remove Background Color</b>	Change the amount of background colour that is removed.
<b>Brightness</b>	Select the brightness level.
<b>Contrast</b>	Select the contrast level.
<b>Use PIN for Authentication</b>	To PIN-protect this profile, select <b>On</b> , and then type a four-digit PIN in the <b>PIN Code</b> field.
<b>Auth. Method</b>	Select the authentication method.
<b>Username</b>	Type a user name (up to 96 characters) that has permission to write data to the folder specified in the <b>Network Folder Path</b> field. If the user name is part of a domain, type the user name in one of the following styles: <b>user@domain</b> <b>domain\user</b>
<b>Password</b>	Type the password (up to 32 characters) associated with the user name you entered in the <b>Username</b> field. Type the password again in the <b>Retype password</b> field.
<b>Kerberos Server Address</b>	Type the Kerberos Server Address (for example: kerberos.example.com; up to 64 characters).

7. Click **Submit**.
8. You must configure the SNTP (network time server) or you must set the date, time and time zone correctly on the control panel. The time must match the time used by the Kerberos Server and CIFS Server.



### Related Information

- [Scan to Network \(Windows\)](#)
  - [Set the Date and Time Using Web Based Management](#)

## Set the Date and Time Using Web Based Management

Make sure the date and time and the time zone settings are set correctly using Web Based Management or the control panel, so the machine's time matches the time being used by the server providing authentication.

Start with Step 2 if you already have a Web Based Management window open.

1. Start your web browser.

Type "https://machine's IP address" in your browser's address bar (where "machine's IP address" is the IP address of the machine or the print server name). For example: https://192.168.1.2

If the machine prompts you for a password, type it, and then click .

2. Click the **Administrator** tab.
3. Click the **Date&Time** menu in the left navigation bar.

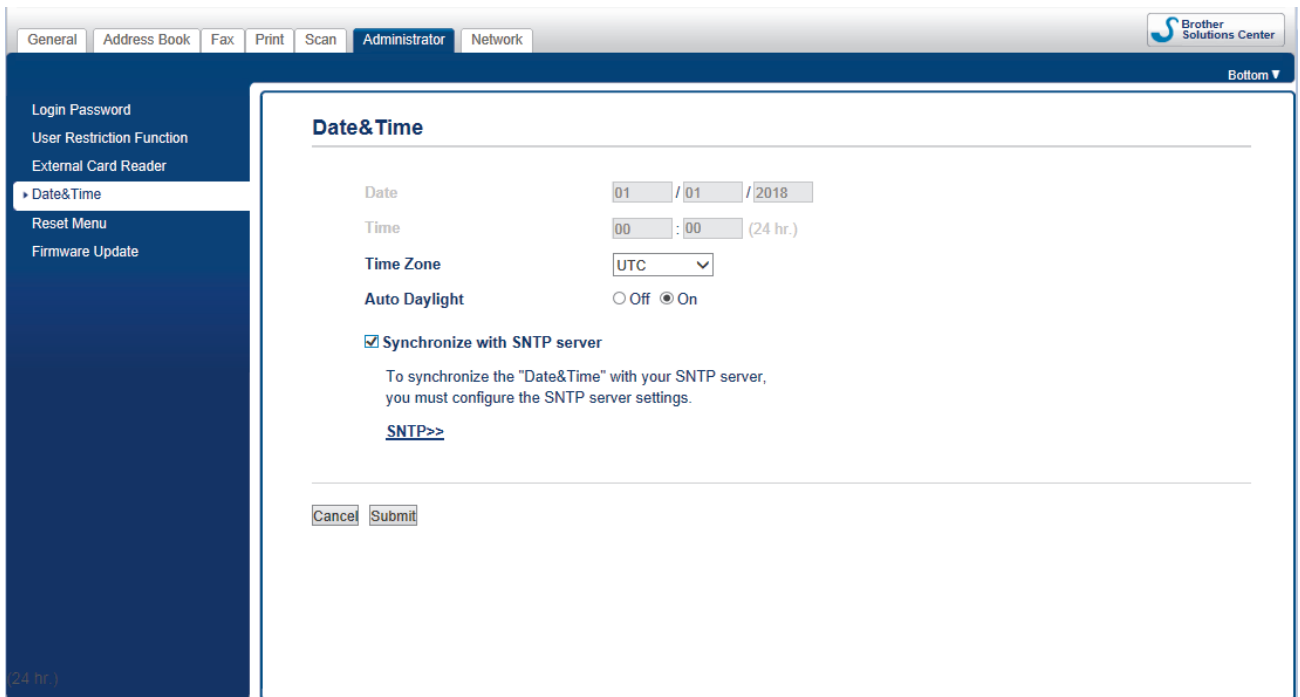

The screenshot shows the Brother Web Based Management interface. The top navigation bar includes tabs for General, Address Book, Fax, Print, Scan, Administrator, and Network. The Administrator tab is selected. On the left, a navigation menu lists options: Login Password, User Restriction Function, External Card Reader, Date&Time (selected), Reset Menu, and Firmware Update. The main content area is titled "Date&Time" and contains the following settings:

- Date:** 01 / 01 / 2018
- Time:** 00 : 00 (24 hr.)
- Time Zone:** UTC (dropdown menu)
- Auto Daylight:**  Off  On
- Synchronize with SNTP server**  
To synchronize the "Date&Time" with your SNTP server, you must configure the SNTP server settings.  
[SNTP>>](#)

At the bottom of the form are "Cancel" and "Submit" buttons.

4. In the **Date** fields, enter the date.
5. Select either 12h Clock or 24h Clock as your **Clock Type** (available only for certain countries).
6. In the **Time** fields, enter the time.
7. Select the time difference between your location and UTC from the **Time Zone** drop-down list, for example, the time zone for Eastern time in the USA and Canada is UTC-05:00.
8. Click the **On** option for **Auto Daylight** to set the machine to change automatically for daylight saving time. It will reset itself forward one hour in the spring, and back one hour in the fall/autumn (available only for certain countries).
9. Click **Submit**.



### Related Information

- [Set up a Scan to Network Profile](#)

## Upload Scanned Data to a CIFS Server

1. Load your document.
2. Press [Scan] > [to Network].



- If you registered your user ID, the [to My Folder] option appears when you log on to the machine using Active Directory Authentication or LDAP Authentication.
- To send scanned data to your designated folder on the CIFS server, press [to My Folder].
- To enable this feature in Web Based Management, click the **Scan** tab, and then click the **Scan to FTP/SFTP/Network/SharePoint** menu in the left navigation bar. In the **Send to My Folder** field, select **On**.

3. The server profiles you have set up using Web Based Management are listed. Select the profile you want. If the profile is not complete (for example, if the logon account name and password are missing, or if the quality or file type is not specified), you will be prompted to enter any missing information.
4. Press [Start].

The machine starts scanning. If you are using the scanner glass, follow the Touchscreen instructions to complete the scanning job.



### Related Information

- [Scan to Network \(Windows\)](#)

## Scan to SharePoint

Scan documents directly to a SharePoint server when you need to share the scanned information. For added convenience, configure different profiles to save your favourite Scan to SharePoint destinations.

- [Set up a Scan to SharePoint Profile](#)
- [Upload Scanned Data to a SharePoint Server](#)

## Set up a Scan to SharePoint Profile

Set up a Scan to SharePoint Profile to scan and upload the scanned data directly to a SharePoint location.

We recommend Microsoft Internet Explorer 11/Microsoft Edge for Windows, and Safari 10/11 for Mac. Make sure that JavaScript and Cookies are always enabled in whichever browser you use.

1. Start your web browser.

Type "https://machine's IP address" in your browser's address bar (where "machine's IP address" is the IP address of the machine or the print server name). For example: https://192.168.1.2

If the machine prompts you for a password, type it, and then click .

2. Click the **Scan** tab.
3. Click the **Scan to FTP/SFTP/Network/SharePoint** menu in the left navigation bar.
4. Select the **SharePoint** option, and then click **Submit**.

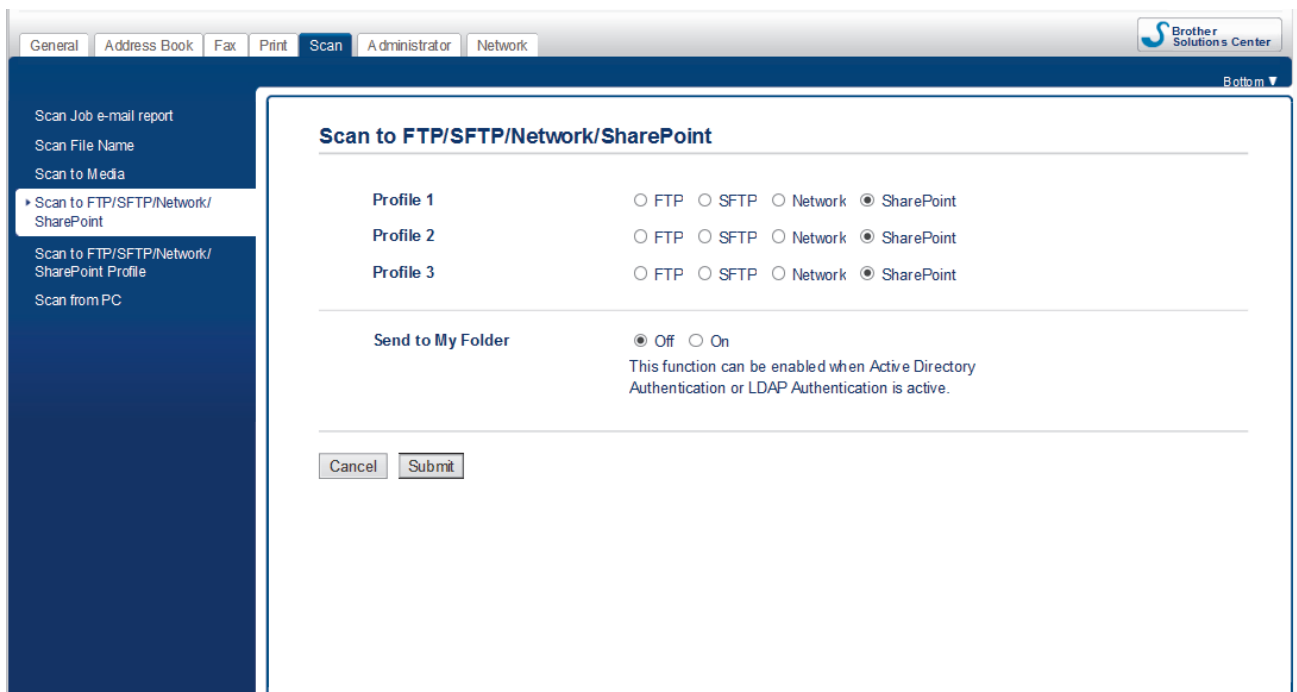

5. Click the **Scan to FTP/SFTP/Network/SharePoint Profile** menu in the left navigation bar.
6. Select the profile you want to set up or change.



Using the following characters: ?, /, \, ", :, <, >, | or \* may cause a sending error.

Option	Description
<b>Profile Name</b>	Type a name for this server profile (up to 15 alphanumeric characters). The machine will display this name on the LCD.
<b>SharePoint Site Address</b>	Copy and paste the full destination address shown in the address bar of your browser (for example: http://SharePointSiteAddress/Shared%20Documents/Forms/AllItems.aspx) or the IP address (for example: http://192.168.0.1/Shared%20Documents/Forms/AllItems.aspx).
<b>File Name</b>	Select a file name from the preset names provided, or from user-defined names. You can set the user-defined names and file name style in the <b>Scan File Name</b> menu in the left navigation bar.



Option	Description
<b>Quality</b>	Select a quality setting. If you choose the <b>User Select</b> option, the machine will prompt users to select a setting each time they use the scan profile.
<b>File Type</b>	Select the file type you want to use for the scanned document. If you choose the <b>User Select</b> option, the machine will prompt users to select a setting each time they use the scan profile.
<b>Document Size</b>	Select your document size from the list. This is necessary to make sure the scanned file is the correct size.
<b>Scan Long Paper (ADF)</b>	Select the <b>On</b> option to scan a document printed on long paper using the ADF.
<b>ADF Auto Deskew</b>	Select <b>Auto</b> to set the machine to correct document skewing automatically as the pages are scanned from the ADF.
<b>Skip Blank Page</b>	Select the <b>On</b> option to remove blank pages of the document from the scanning results.
<b>Skip Blank Page Sensitivity</b>	Select the sensitivity level for detecting blank pages in the scanned data. The higher the sensitivity, the easier it is for the machine to detect blank pages.
<b>Remove Background Color</b>	Change the amount of background colour that is removed.
<b>Brightness</b>	Select the brightness level.
<b>Contrast</b>	Select the contrast level.
<b>Use PIN for Authentication</b>	To PIN-protect this profile, select <b>On</b> , and then type a four-digit PIN in the <b>PIN Code</b> field.
<b>Auth. Method</b>	Select the authentication method. If you select <b>Auto</b> , the authentication method will be automatically detected.
<b>Username</b>	Type a user name (up to 96 characters) that has permission to write data to the folder specified in the <b>SharePoint Site Address</b> field. If the user name is part of a domain, type the user name in one of the following styles: <b>user@domain</b> <b>domain\user</b>
<b>Password</b>	Type the password (up to 32 characters) associated with the user name you entered in the <b>Username</b> field. Type the password again in the <b>Retype password</b> field.
<b>Kerberos Server Address</b>	Type the Kerberos Server Address (for example: kerberos.example.com; up to 64 characters).

7. Click **Submit**.



## Related Information

- [Scan to SharePoint](#)

## Upload Scanned Data to a SharePoint Server

1. Load your document.
2. Press [Scan] > [to SharePoint].
3. The server profiles you have set up using Web Based Management are listed. Select the profile you want. If the profile is not complete (for example, if the logon account name and password are missing, or if the quality or file type is not specified), you will be prompted to enter any missing information.
4. Press [Start].

The machine starts scanning. If you are using the scanner glass, follow the Touchscreen instructions to complete the scanning job.



### Related Information

- [Scan to SharePoint](#)

## Web Services for Scanning on Your Network (Windows 7, Windows 8 and Windows 10)

The Web Services protocol enables Windows 7, Windows 8 and Windows 10 users to scan using a Brother machine on the network. You must install the driver via Web Services.

- [Use Web Services to Install Drivers Used for Scanning \(Windows 7, Windows 8, and Windows 10\)](#)
- [Scan Using Web Services from the Brother Machine \(Windows 7, Windows 8 and Windows 10\)](#)
- [Configure Scan Settings for Web Services](#)

## Use Web Services to Install Drivers Used for Scanning (Windows 7, Windows 8, and Windows 10)

Use Web Services to monitor printers on the network.

- Make sure you have installed the Brother software and drivers.
- Verify that the host computer and the Brother machine are on the same subnet, or that the router is correctly configured to pass data between the two devices.
- You must configure the IP address on your Brother machine before you configure this setting.

1. Do one of the following:

- Windows 7

Click  (**Start**) > **Control Panel** > **Network and Internet** > **View network computers and devices**.

The machine's Web Services Name appears with the printer icon.

Right-click the machine you want to install.

- Windows 8

Move your mouse to the lower right corner of your desktop. When the menu bar appears, click **Settings** > **Change PC settings** > **Devices** > **Add a device**.

The machine's Web Services Name appears.

- Windows 8.1

Move your mouse to the lower right corner of your desktop. When the menu bar appears, click **Settings** > **Change PC settings** > **PC and devices** > **Devices** > **Add a device**.

The machine's Web Services Name appears.

- Windows 10

Click  > **Windows System** > **Control Panel**. In the **Hardware and Sound** group, click **Add a device**.



- The Web Services Name for the Brother machine is your model name and the MAC Address (Ethernet Address) of your machine (for example, Brother MFC-XXXX (model name) [XXXXXXXXXXXX] (MAC Address / Ethernet Address)).
- Windows 8/Windows 10  
Move your mouse over the machine name to display the machine's information.

2. Do one of the following:

- Windows 7

Click **Install** in the displayed menu.

- Windows 8/Windows 10

Select the machine you want to install, and then follow the on-screen instructions.



To uninstall drivers, click **Uninstall** or  (**Remove device**).



### Related Information

- [Web Services for Scanning on Your Network \(Windows 7, Windows 8 and Windows 10\)](#)

## Scan Using Web Services from the Brother Machine (Windows 7, Windows 8 and Windows 10)

If you have installed the driver for scanning via Web Services, you can access the Web Services scanning menu on your Brother machine's LCD.

- Certain characters in the messages displayed on the LCD may be replaced with spaces if the language settings of your OS and your Brother machine are different.
- If the LCD displays an insufficient memory error message, choose a smaller size in the **Paper size** setting or a lower resolution in the **Resolution (DPI)** setting.

1. Load your document.
2. Press [Scan] > [WS Scan].
3. Press ▲ or ▼ to select the type of scan you want, and then press it.
4. Press ▲ or ▼ to display the computer where you want to send data, and then press the computer name.
5. Press [Start].

The machine starts scanning.



### Related Information

- [Web Services for Scanning on Your Network \(Windows 7, Windows 8 and Windows 10\)](#)

## Configure Scan Settings for Web Services

1. Do one of the following:

- Windows 7

Click  (**Start**) > **Devices and Printers**.

- Windows 8

Move your mouse to the lower right corner of your desktop. When the menu bar appears, click **Settings**, and then click **Control Panel**. In the **Hardware and Sound** group, click **View devices and printers**.

- Windows 10

Click  > **Windows System** > **Control Panel**. In the **Hardware and Sound** group, click **View devices and printers**.

2. Right-click the machine icon, and then select **Scan profiles....** The **Scan Profiles** dialog box appears.

3. Select the scan profile you want to use.

4. Make sure the scanner selected in the **Scanner** list is a Brother machine that supports Web Services for scanning, and then click the **Set as Default** button.

5. Click **Edit...**

The **Edit Default Profile** dialog box appears.

6. Select the **Source**, **Paper size**, **Color format**, **File type**, **Resolution (DPI)**, **Brightness** and **Contrast** settings.

7. Click the **Save Profile** button.

These settings will be applied when you scan using the Web Services protocol.

If you are requested to select a scanning application, select Windows Fax and Scan from the list.



### Related Information

- [Web Services for Scanning on Your Network \(Windows 7, Windows 8 and Windows 10\)](#)

## Change Scan Button Settings from ControlCenter4 (Windows)

1. Click the  (ControlCenter4) icon in the task tray, and then click **Open**.
2. Click the **Device Settings** tab.
3. Click the **Device Scan Settings** button.

The **Device Scan Settings** dialog box appears.

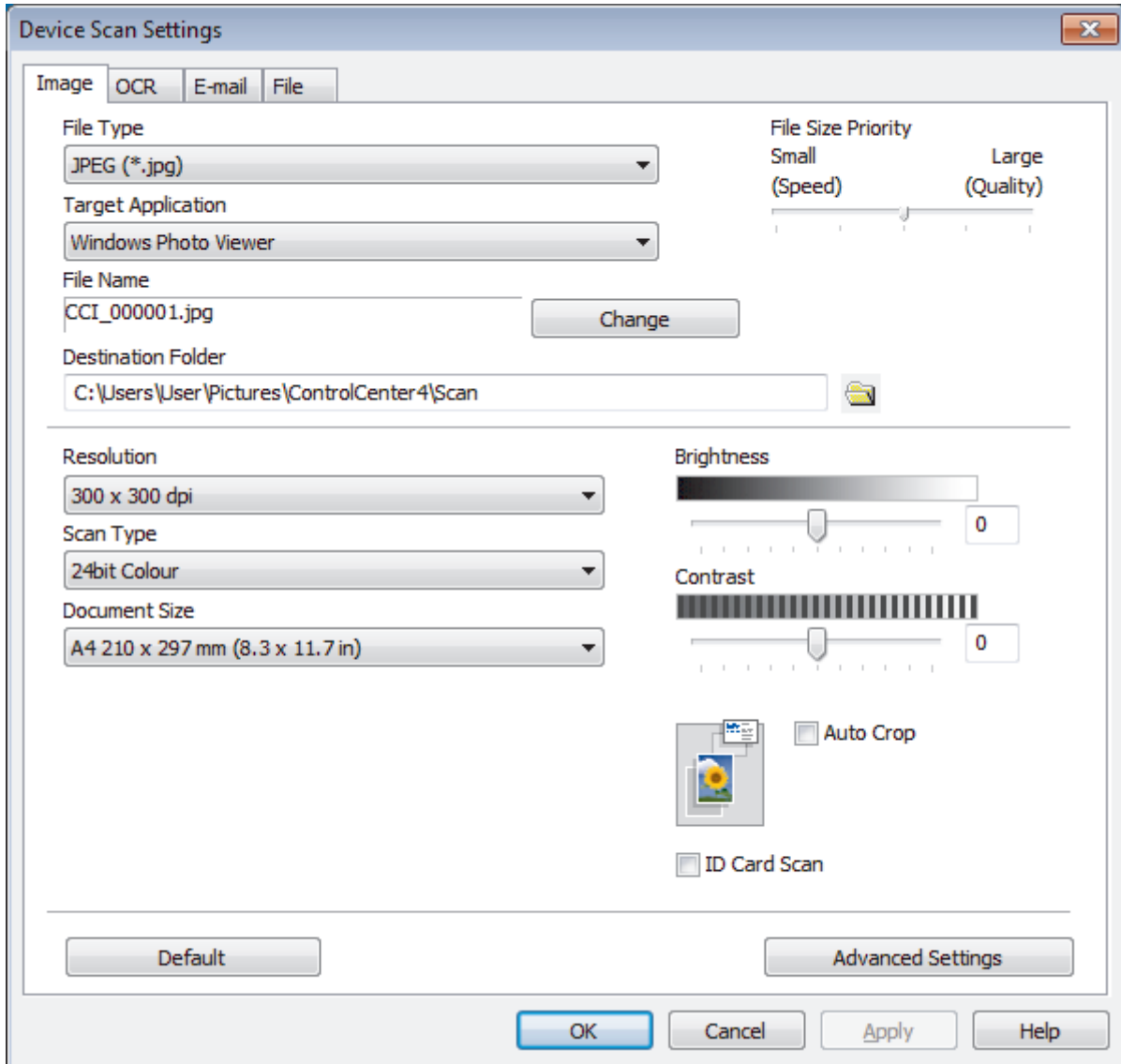

4. Click the tab for the Scan to action you want to change (**Image**, **OCR**, **E-mail**, or **File**).
5. Change the settings, as needed.
6. Click **OK**.



Each tab corresponds to a scan feature, as described below.

These settings can be changed.

Click the tabs, and then change the settings.

Tab Name	Corresponding Feature
Image	Scan to Image
OCR	Scan to OCR
E-mail	Scan to Email
File	Scan to File

Settings	Applicable Features			
	Image	OCR	E-mail	File
File Type	Yes	Yes	Yes	Yes
Target Application	Yes	Yes	-	-
OCR Language (Available only for certain models)	-	Yes	-	-
File Name	Yes	Yes	Yes	Yes
Destination Folder	Yes	Yes	Yes	-
Scan Location	-	-	-	Yes
File Size Priority	Yes	-	Yes	Yes
Resolution	Yes	Yes	Yes	Yes
Scan Type	Yes	Yes	Yes	Yes
Document Size	Yes	Yes	Yes	Yes
Brightness	Yes	Yes	Yes	Yes
Contrast	Yes	Yes	Yes	Yes
Auto Crop	Yes	-	Yes	Yes
ID Card Scan	Yes	Yes	Yes	Yes
Advanced Settings	Yes	Yes	Yes	Yes
Default	Yes	Yes	Yes	Yes

### File Type

Select the file type you want to use for the scanned data.

### Target Application

Select the destination application from the drop-down list.

### OCR Language

Set the optical character recognition (OCR) language to match the language of the scanned document's text (Available only for certain models).

### File Name

Type a prefix for your file name, if needed.

### Destination Folder

Click the folder icon to browse and select the folder where you want to save your scanned documents.

### Scan Location

Select the **Folder** or **SharePoint** radio button to specify the destination where you want to save your scanned documents.



---

## File Size Priority

Adjust the data compression ratio of the scanned image. Change the file size by moving the **File Size Priority** slider to the right or left.

## Resolution

Select a scanning resolution from the **Resolution** drop-down list. Higher resolutions take more memory and transfer time, but produce a finer scanned image.

## Scan Type

Select from a range of scan colour depths.

- **Auto**  
Use for any type of document. This mode automatically picks an appropriate colour depth for the document.
- **Black & White**  
Use for text or line art images.
- **Grey (Error Diffusion)**  
Use for photographic images or graphics. (Error Diffusion is a method for creating simulated grey images without using true grey dots. Black dots are put in a specific pattern to give a grey appearance.)
- **True Grey**  
Use for photographic images or graphics. This mode is more accurate because it uses up to 256 shades of grey.
- **24bit Colour**  
Use to create an image with the most accurate colour reproduction. This mode uses up to 16.8 million colours to scan the image, but it requires the most memory and has the longest transfer time.

## Document Size

Select the exact size of your document from the **Document Size** drop-down list.

- If you select the **1 to 2 (A4)** option, the scanned image will be divided into two A5-size documents.

## Brightness

Set the **Brightness** level by dragging the slider to the right or left to lighten or darken the image. If the scanned image is too light, set a lower brightness level and scan the document again. If the image is too dark, set a higher brightness level and scan the document again. You can also type a value into the field to set the **Brightness** level.

## Contrast

Increase or decrease the **Contrast** level by moving the slider to the right or left. An increase emphasises dark and light areas of the image, while a decrease reveals more details in grey areas. You can also type a value into the field to set the **Contrast** level.

## Auto Crop

Scan multiple documents placed on the scanner glass. The machine will scan each document and create separate files or a single multi-page file.

## ID Card Scan

Select this check box to scan both sides of an identification card onto one page.

## Advanced Settings

Click the **Advanced Settings** button in the scan settings dialog box to configure advanced settings.

- **Remove Bleed-through / Pattern**
  - **Remove Background Colour**  
Remove the base colour of documents to make the scanned data more legible.
- **Rotate Image**  
Rotate the scanned image.
- **Skip Blank Page**  
Remove the document's blank pages from the scanning results.

---

- **Display Scanning Results**

Show on your computer screen the number of total pages saved, and blank pages skipped.

- **ADF Auto Deskew**

Set the machine to automatically correct a skewed document. (Available only for certain models)

**Default**

Select this option to restore all settings to their factory setting values.



## **Related Information**

- [Scan Using the Scan Button on Your Brother Machine](#)
-

## Change Scan Button Settings from Brother iPrint&Scan (Mac)

1. In the **Finder** menu bar, click **Go > Applications**, and then double-click the iPrint&Scan icon.  
The Brother iPrint&Scan screen appears.
2. If your Brother machine is not selected, click the **Select your Machine** button, and then follow the on-screen instructions to select your Brother machine.
3. Click the **Machine Scan Settings** button, and then follow the on-screen instructions to change the scan settings.



### Related Information

- [Scan Using the Scan Button on Your Brother Machine](#)

#### Related Topics:

- [Scan Using Brother iPrint&Scan \(Mac\)](#)
-

## Scan from Your Computer (Windows)

There are several ways you can use your computer to scan photos and documents on your Brother machine. Use the software applications provided by Brother, or use your favourite scanning application.

- [Scan Using ControlCenter4 Home Mode \(Windows\)](#)
- [Scan Using ControlCenter4 Advanced Mode \(Windows\)](#)
- [Scan Using Nuance™ PaperPort™ 14SE or Other Windows Applications](#)
- [Scan Using Windows Fax and Scan](#)
- [Install BookScan Enhancer and Whiteboard Enhancer \(Windows\)](#)

## Scan Using ControlCenter4 Home Mode (Windows)

Use ControlCenter4 Home Mode to access your machine's main features.





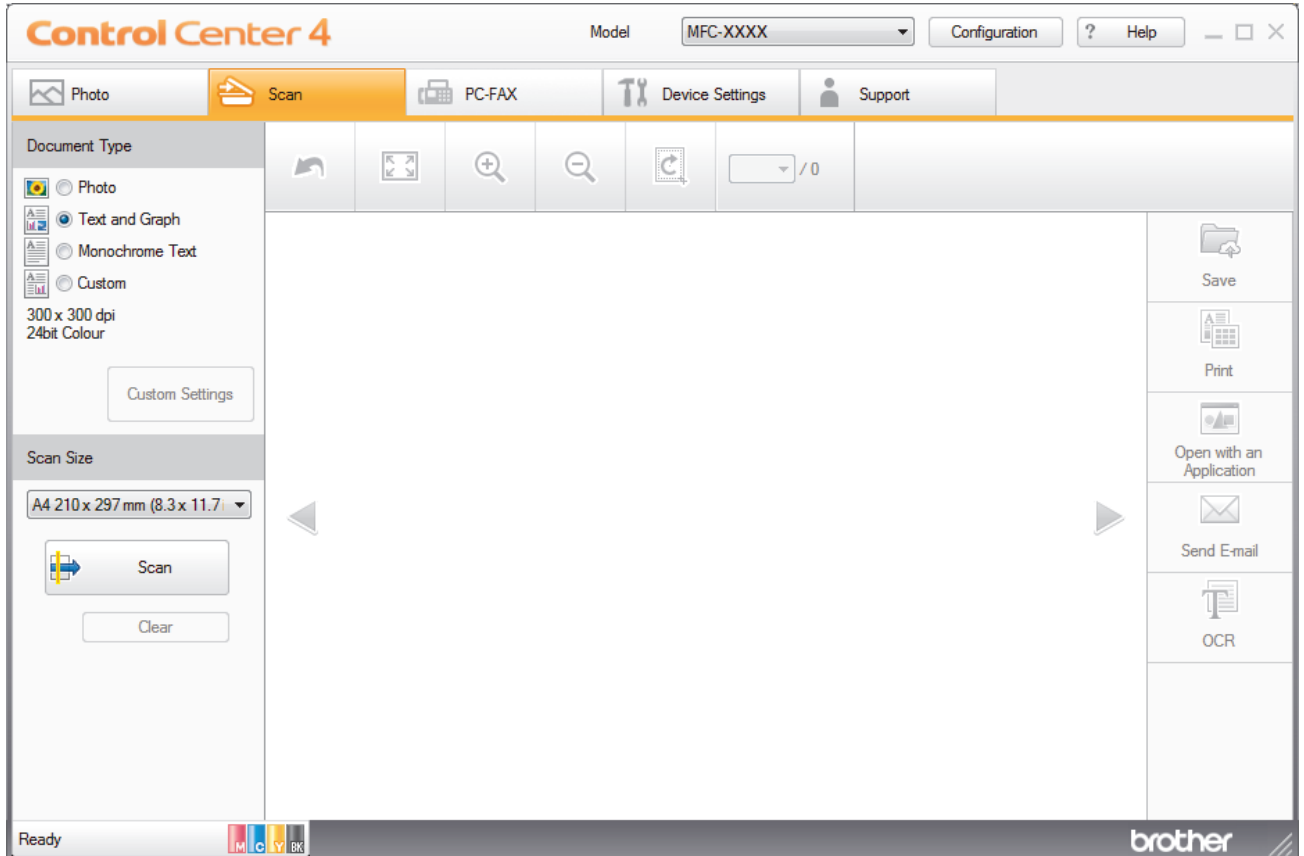

- [Scan Using ControlCenter4 Home Mode \(Windows\)](#)
- [Save Scanned Data to a Folder as a PDF File Using ControlCenter4 Home Mode \(Windows\)](#)
- [Scan Settings for ControlCenter4 Home Mode \(Windows\)](#)
- [Change the Operation Mode in ControlCenter4 \(Windows\)](#)

## Scan Using ControlCenter4 Home Mode (Windows)

Select **Home Mode** as the mode setting for ControlCenter4.

1. Load your document.
2. Click the  (**ControlCenter4**) icon in the task tray, and then click **Open**.
3. Click the **Scan** tab.



4. Select the **Document Type**.
  5. Change the document's **Scan Size**, if needed.
  6. Click  (**Scan**).
- The machine starts scanning, and the scanned image appears in the image viewer.
7. If you scanned multiple pages using the ADF, click the left or right arrow buttons to preview each scanned page.
  8. Crop the scanned image, if needed.
  9. Do one of the following:
    - Click  (**Save**) to save scanned data.
    - Click  (**Print**) to print scanned data.
    - Click  (**Open with an Application**) to open scanned data in another application.
    - Click  (**Send E-mail**) to attach scanned data to an email.
    - Click  (**OCR**) to convert your scanned document to an editable text file. (available only for certain models)



---

## Related Information

---

- [Scan Using ControlCenter4 Home Mode \(Windows\)](#)
    - [Select Document Type Using ControlCenter4 Home Mode \(Windows\)](#)
    - [Change Scan Size Using ControlCenter4 Home Mode \(Windows\)](#)
    - [Crop a Scanned Image Using ControlCenter4 Home Mode \(Windows\)](#)
    - [Print Scanned Data Using ControlCenter4 Home Mode \(Windows\)](#)
    - [Open with an Application Using ControlCenter4 Home Mode \(Windows\)](#)
-

[Home](#) > [Scan](#) > [Scan from Your Computer \(Windows\)](#) > [Scan Using ControlCenter4 Home Mode \(Windows\)](#) > [Scan Using ControlCenter4 Home Mode \(Windows\)](#) > [Select Document Type Using ControlCenter4 Home Mode \(Windows\)](#)

## Select Document Type Using ControlCenter4 Home Mode (Windows)

- Select the **Document Type** option that matches the type of original you want to scan.

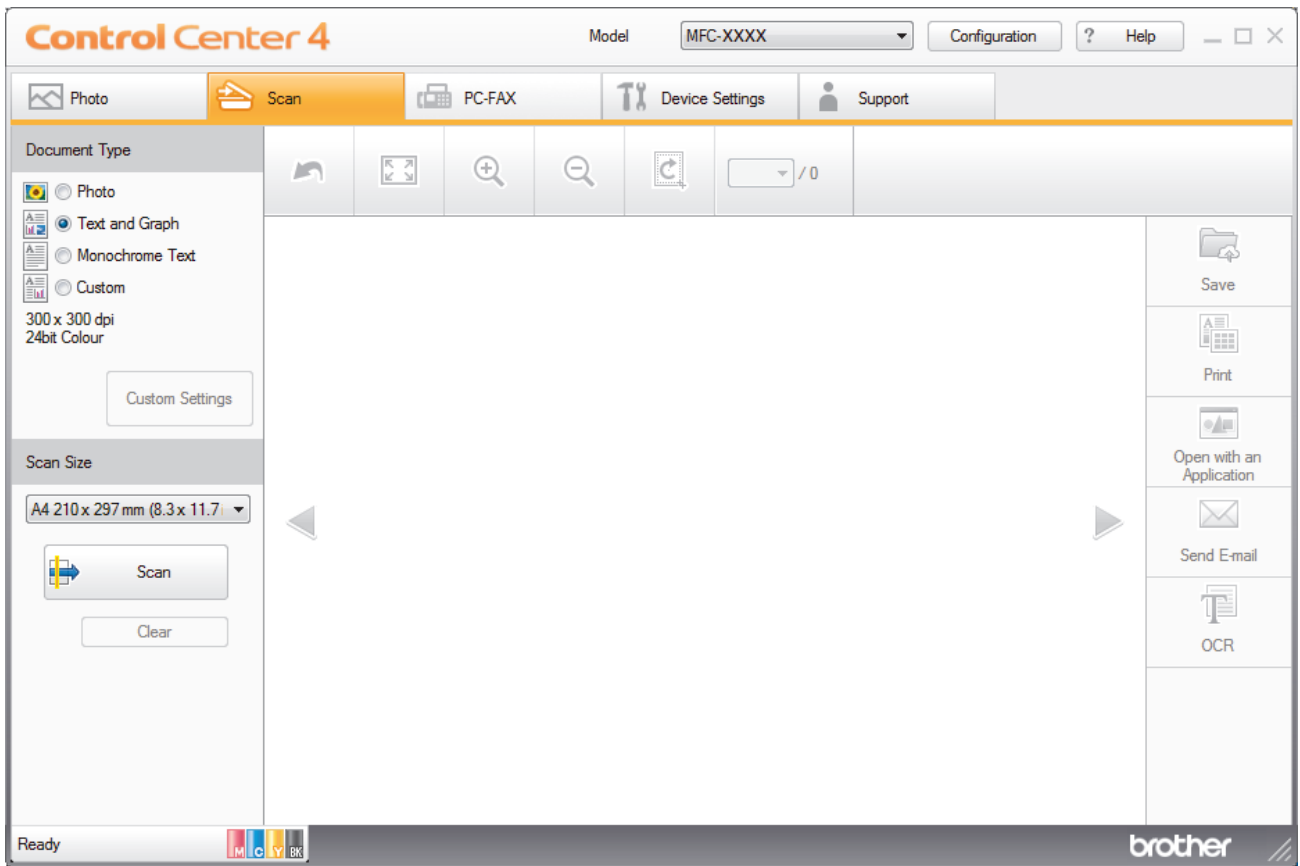

Option	Description
<b>Photo</b>	<b>600 x 600 dpi 24bit Colour</b>
<b>Text and Graph</b>	<b>300 x 300 dpi 24bit Colour</b>
<b>Monochrome Text</b>	<b>200 x 200 dpi Black &amp; White</b>
<b>Custom</b>	<b>300 x 300 dpi (24bit Colour as default) Select the scan settings you want from the Custom Settings button.</b>

### ✓ Related Information

- [Scan Using ControlCenter4 Home Mode \(Windows\)](#)
  - [Custom Scan Settings \(Windows\)](#)



## Custom Scan Settings (Windows)

Select **Custom** in the **Document Type** list to change advanced scan settings.

- Select **Custom**, and then click the **Custom Settings** button.

The **Custom Scan Settings** dialog box appears.

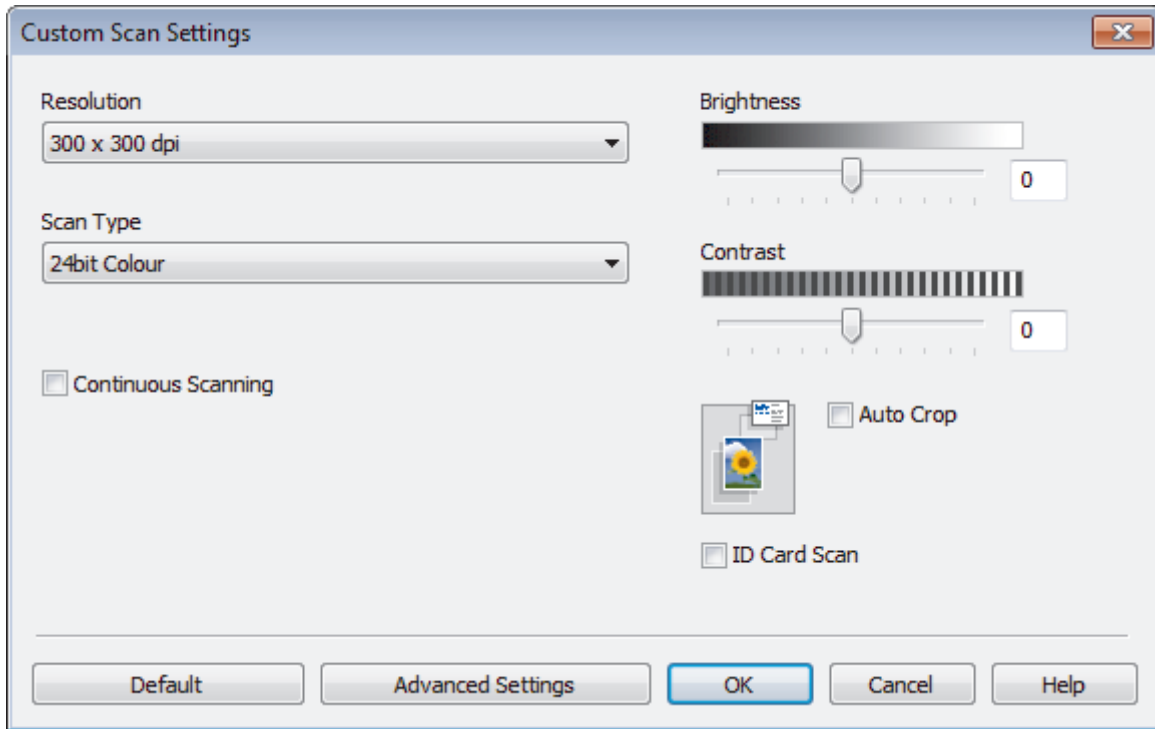

You can change the following settings:

### Resolution

Select a scanning resolution from the **Resolution** drop-down list. Higher resolutions take more memory and transfer time, but produce a finer scanned image.

### Scan Type

Select from a range of scan colour depths.

#### - Auto

Use for any type of document. This mode automatically picks an appropriate colour depth for the document.

#### - Black & White

Use for text or line art images.

#### - Grey (Error Diffusion)

Use for photographic images or graphics. (Error Diffusion is a method for creating simulated grey images without using true grey dots. Black dots are put in a specific pattern to give a grey appearance.)

#### - True Grey

Use for photographic images or graphics. This mode is more accurate because it uses up to 256 shades of grey.

#### - 24bit Colour

Use to create an image with the most accurate colour reproduction. This mode uses up to 16.8 million colours to scan the image, but it requires the most memory and has the longest transfer time.

---

## Brightness

Set the **Brightness** level by dragging the slider to the right or left to lighten or darken the image. If the scanned image is too light, set a lower brightness level and scan the document again. If the image is too dark, set a higher brightness level and scan the document again. You can also type a value into the field to set the **Brightness** level.

## Contrast

Increase or decrease the **Contrast** level by moving the slider to the right or left. An increase emphasises dark and light areas of the image, while a decrease reveals more details in grey areas. You can also type a value into the field to set the **Contrast** level.

## Auto Crop

Scan multiple documents placed on the scanner glass. The machine will scan each document and create separate files or a single multi-page file.

## Continuous Scanning

Select this option to scan multiple pages. After a page is scanned, select either continue scanning or finish.

## ID Card Scan

Select this check box to scan both sides of an identification card onto one page.

## Advanced Settings

Configure advanced settings by clicking the **Advanced Settings** button in the Scan Settings dialog box.

- **Remove Bleed-through / Pattern**
  - **Remove Background Colour**

Remove the base colour of documents to make the scanned data more legible. (Available only for certain models)
- **Rotate Image**

Rotate the scanned image.
- **Skip Blank Page**

Remove the document's blank pages from the scanning results.
- **Display Scanning Results**

Show on your computer screen the number of total pages saved, and blank pages skipped.
- **ADF Auto Deskew**

Set the machine to automatically correct a skewed document. (Available only for certain models)



## Related Information

- [Select Document Type Using ControlCenter4 Home Mode \(Windows\)](#)
-

Home > Scan > Scan from Your Computer (Windows) > Scan Using ControlCenter4 Home Mode (Windows) > Scan Using ControlCenter4 Home Mode (Windows) > Change Scan Size Using ControlCenter4 Home Mode (Windows)

## Change Scan Size Using ControlCenter4 Home Mode (Windows)

For faster scan speeds, select the exact size of your document from the **Scan Size** drop-down menu.

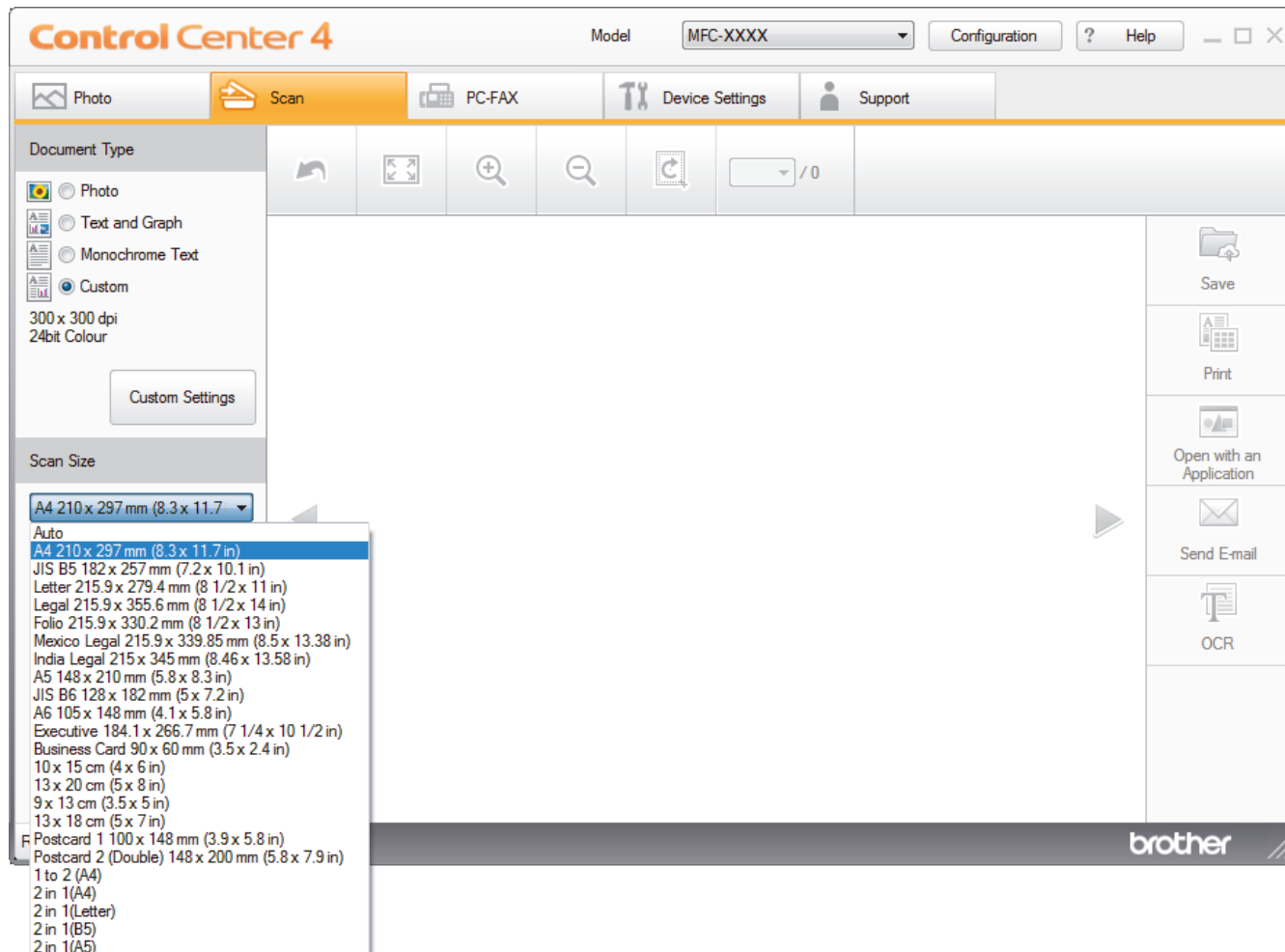

### ✓ Related Information

- [Scan Using ControlCenter4 Home Mode \(Windows\)](#)

## Crop a Scanned Image Using ControlCenter4 Home Mode (Windows)

The crop tool on the Image Editing Toolbar lets you trim unwanted areas from your scanned image. Use the **Zoom In** and **Zoom Out** tools to help view the image to be cropped.

### Image Editing Toolbar

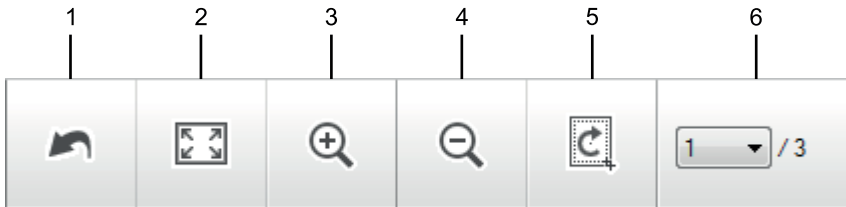

#### 1. Restart

Cancels all the edits applied to the selected image. The edited image returns to its original state.

#### 2. Fit to Window

Displays the scanned image so that the entire image fits in the window.

#### 3. Zoom In

Zooms in on the scanned image.

#### 4. Zoom Out

Zooms out of the scanned image.

#### 5. Crop and Edit

Removes the outer parts of the image. Click the **Crop and Edit** button, and then change the frame to contain the area you want to keep after cropping.

#### 6. Page Counter

Indicates the page number of the scanned page currently shown in the image viewer. To display a different page, select the desired page number from the drop-down page number list.



If you have scanned multiple pages, you can see the next or previous scanned page by clicking the left or right arrow buttons in the preview window.

1. Scan a document.

2. Click  (**Crop and Edit**) to edit the scanned image.

The **Crop and Edit - ControlCenter4** window appears.

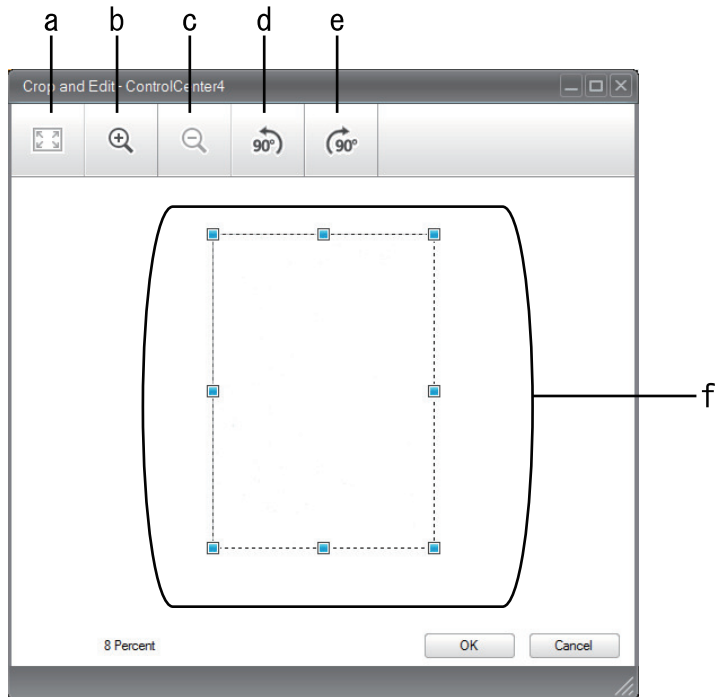

- a. Expands the scanned image so that the entire image fits in the window.
  - b. Zooms in on the image.
  - c. Zooms out of the image.
  - d. Rotates the image counter-clockwise 90 degrees.
  - e. Rotates the image clockwise 90 degrees.
  - f. Click and drag the frame to adjust the area to be cropped.
3. Click **OK**.
- The edited image appears in the image viewer.



### Related Information

- [Scan Using ControlCenter4 Home Mode \(Windows\)](#)

Home > Scan > Scan from Your Computer (Windows) > Scan Using ControlCenter4 Home Mode (Windows) > Scan Using ControlCenter4 Home Mode (Windows) > Print Scanned Data Using ControlCenter4 Home Mode (Windows)

## Print Scanned Data Using ControlCenter4 Home Mode (Windows)

Scan a document on your Brother machine, and then print copies using the printer driver features that are available in ControlCenter4.

1. Scan a document.
2. Click **Print**.

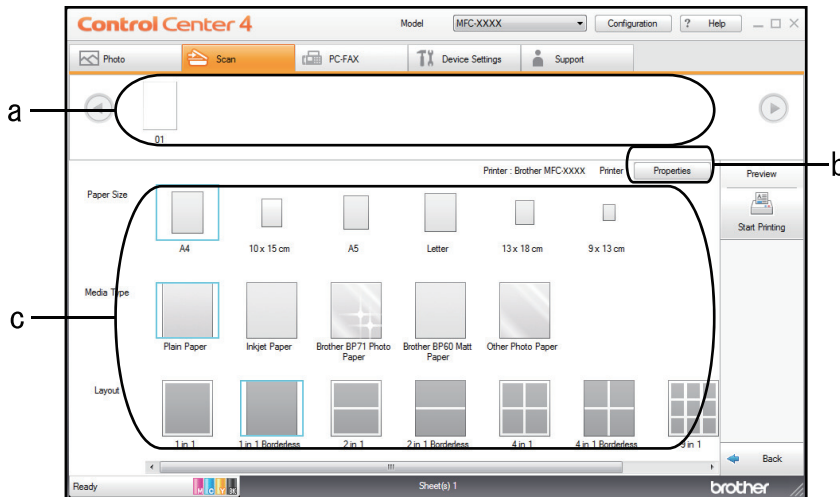

- a. Shows which images are currently selected.
  - b. Click the **Properties** button to change specific printer settings.
  - c. Select the **Paper Size**, **Media Type** and **Layout** options. The current settings are enclosed in a blue square.
3. Configure the print settings, and then click the **Start Printing** button.



### Related Information

- [Scan Using ControlCenter4 Home Mode \(Windows\)](#)

---

▲ [Home](#) > [Scan](#) > [Scan from Your Computer \(Windows\)](#) > [Scan Using ControlCenter4 Home Mode \(Windows\)](#) > [Scan Using ControlCenter4 Home Mode \(Windows\)](#) > [Open with an Application Using ControlCenter4 Home Mode \(Windows\)](#)

## Open with an Application Using ControlCenter4 Home Mode (Windows)

The **Open with an Application** button lets you scan an image directly into your graphics application for editing.

1. Scan a document.
2. Click the **Open with an Application** button.
3. Select the application from the drop-down list, and then click **OK**.

The image will be opened in the application you have selected.



### Related Information

- [Scan Using ControlCenter4 Home Mode \(Windows\)](#)
-

## Save Scanned Data to a Folder as a PDF File Using ControlCenter4 Home Mode (Windows)

Select **Home Mode** as the mode setting for ControlCenter4.

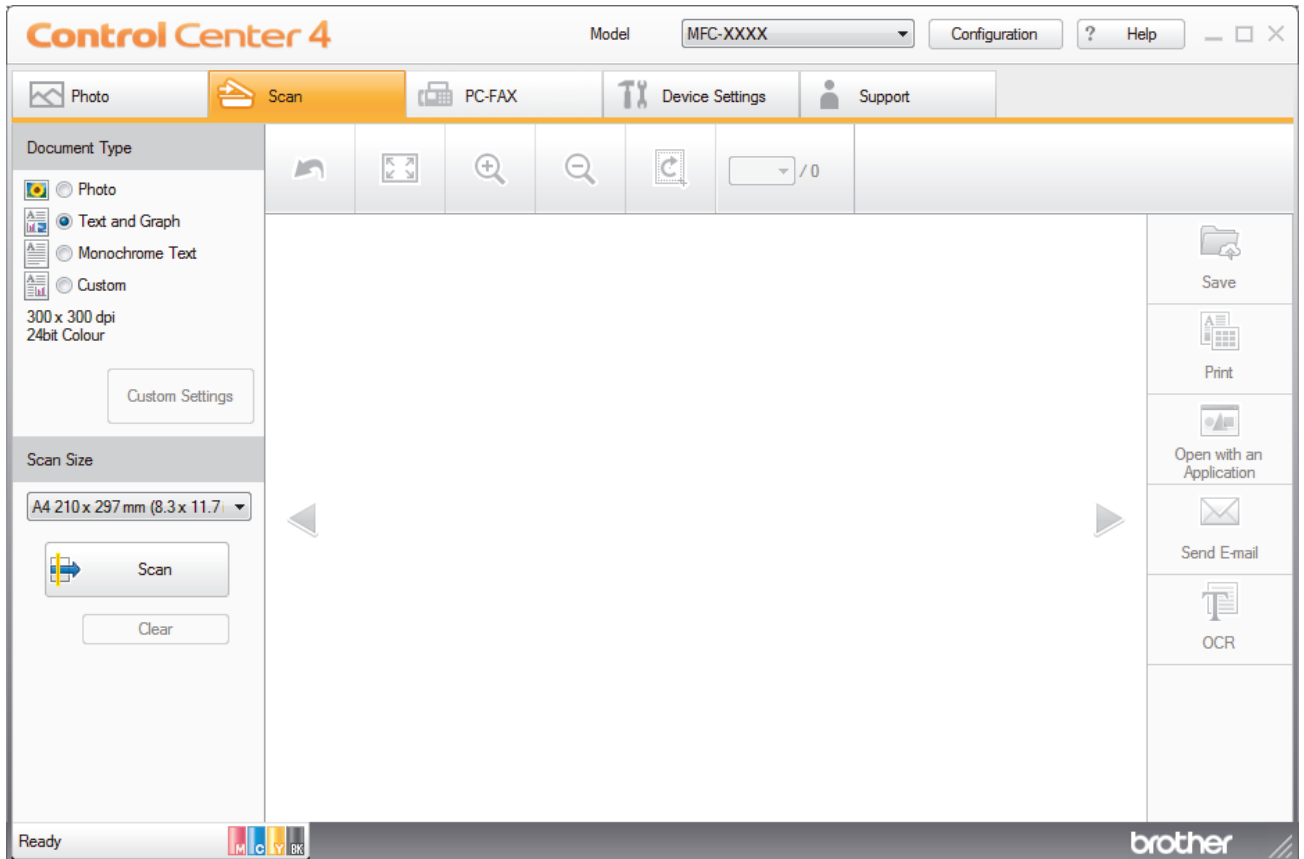

1. Load your document.
2. Click the  (**ControlCenter4**) icon in the task tray, and then click **Open**.
3. Click the **Scan** tab.



4. Select the **Document Type**.
  5. Change the size of your document, if needed.
  6. Click  (**Scan**).
- The machine starts scanning, and the scanned image appears in the image viewer.
7. Click the left or right arrow buttons to preview each scanned page.
  8. Click **Save**.
- The **Save** dialog box appears.
9. Click the **File Type** drop-down list, and then select a PDF file.

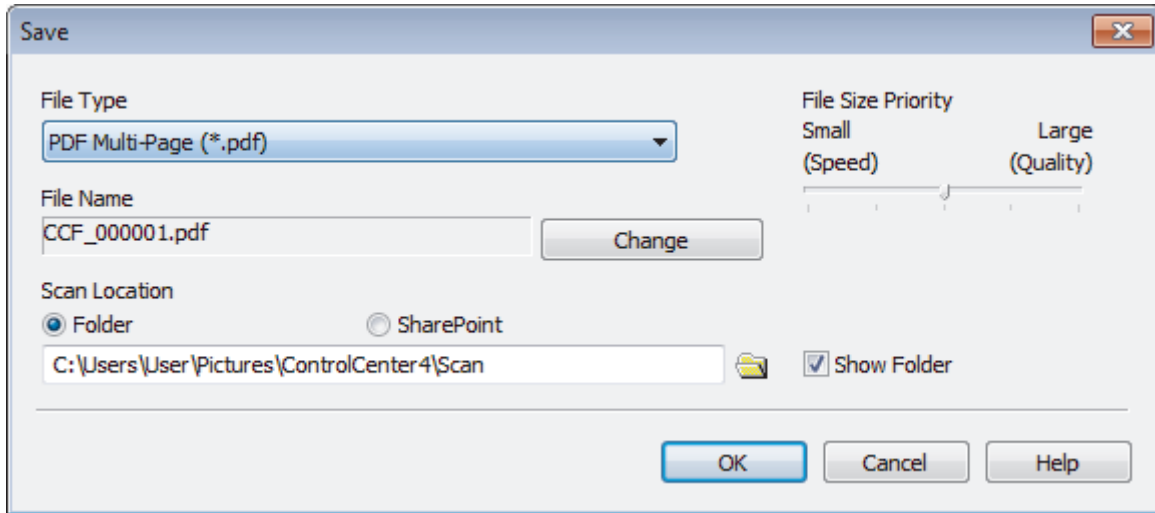



 To save the document as a password-protected PDF, select **Secure PDF Single-Page (\*.pdf)** or **Secure PDF Multi-Page (\*.pdf)** from the **File Type** drop-down list, click , and then type the password.

10. To change the file name, click the **Change** button, if needed.
11. Click the folder icon to browse and select the folder where you want to save your scanned documents.
12. Click **OK**.

The scanned document is saved to the destination folder as a PDF.

### **Related Information**

- [Scan Using ControlCenter4 Home Mode \(Windows\)](#)

## Scan Settings for ControlCenter4 Home Mode (Windows)

Settings	Applicable Features			
	Open with an Application	OCR	Send E-mail	Save
File Type	-	Yes	Yes	Yes
Target Application	Yes	Yes	-	-
OCR Language (Available only for certain models)	-	Yes	-	-
File Name	-	-	-	Yes
Scan Location	-	-	-	Yes
Show Folder	-	-	-	Yes
File Size Priority	-	-	Yes	Yes

### File Type

Select the file type you want to use for the scanned data.

For **Send E-mail** and **Save**:

- **Windows Bitmap (\*.bmp)**
- **JPEG (\*.jpg)** (recommended for most users when scanning pictures)
- **TIFF Single-Page (\*.tif)**
- **TIFF Multi-Page (\*.tif)**
- **Portable Network Graphics (\*.png)**
- **PDF Single-Page (\*.pdf)** (recommended for scanning and sharing documents)
- **PDF Multi-Page (\*.pdf)** (recommended for scanning and sharing documents)
- **High Compression PDF Single-Page (\*.pdf)**
- **High Compression PDF Multi-Page (\*.pdf)**
- **Secure PDF Single-Page (\*.pdf)**
- **Secure PDF Multi-Page (\*.pdf)**
- **Searchable PDF Single-Page (\*.pdf)**
- **Searchable PDF Multi-Page (\*.pdf)**
- **XML Paper Specification (\*.xps)** (the XML Paper Specification is available for Windows 7, Windows 8, and Windows 10, or when using applications that support XML Paper Specification files)
- **Microsoft Office Word (\*.docx)** (Available only for certain models)
- **Microsoft Office PowerPoint (\*.pptx)** (Available only for certain models)
- **Microsoft Office Excel (\*.xlsx)** (Available only for certain models)

For **OCR**:

- **Text (\*.txt)**
- **HTML 3.2 (\*.htm)**
- **HTML 4.0 (\*.htm)**
- **Searchable PDF Single-Page (\*.pdf)**
- **Searchable PDF Multi-Page (\*.pdf)**
- **WordPad (\*.rtf)**
- **RTF Word 2000 (\*.rtf)**
- **WordPerfect 9, 10 (\*.wpd)**

- 
- **Microsoft Excel 2003, XP (\*.xls)**

#### **Target Application**

Select the destination application from the drop-down list.

#### **OCR Language**

Set the optical character recognition (OCR) language to match the language of the scanned document's text (Available only for certain models).

#### **File Name**

Click **Change** to change the file name's prefix.

#### **Scan Location**

Select the **Folder** or **SharePoint** radio button to specify the destination where you want to save your scanned documents.

#### **Show Folder**

Select this option to automatically display the destination folder after scanning.

#### **File Size Priority**

Adjust the data compression ratio of the scanned image. Change the file size by moving the **File Size Priority** slider to the right or left.

#### **Custom Settings**

Select the **Custom** option, click the **Custom Settings** button, and then change settings.

#### **Scan Size**

Select the exact size of your document from the **Scan Size** drop-down menu.



#### **Related Information**

- [Scan Using ControlCenter4 Home Mode \(Windows\)](#)
-

## Scan Using ControlCenter4 Advanced Mode (Windows)

ControlCenter4 Advanced Mode gives you more control over the details of your machine's features and allows you to customise one-button scan actions.

- [Scan Photos and Graphics Using ControlCenter4 Advanced Mode \(Windows\)](#)
- [Save Scanned Data to a Folder as a PDF File Using ControlCenter4 Advanced Mode \(Windows\)](#)
- [Scan Both Sides of an ID Card Using ControlCenter4 Advanced Mode \(Windows\)](#)
- [Scan to Email Attachment Using ControlCenter4 Advanced Mode \(Windows\)](#)
- [Scan to an Editable Text File \(OCR\) Using ControlCenter4 Advanced Mode \(Windows\)](#)
- [Scan to an Office File Using ControlCenter4 Advanced Mode \(Windows\)](#)
- [Scan Settings for ControlCenter4 Advanced Mode \(Windows\)](#)
- [Change the Operation Mode in ControlCenter4 \(Windows\)](#)

## Scan Photos and Graphics Using ControlCenter4 Advanced Mode (Windows)

Send scanned photos or graphics directly to your computer.

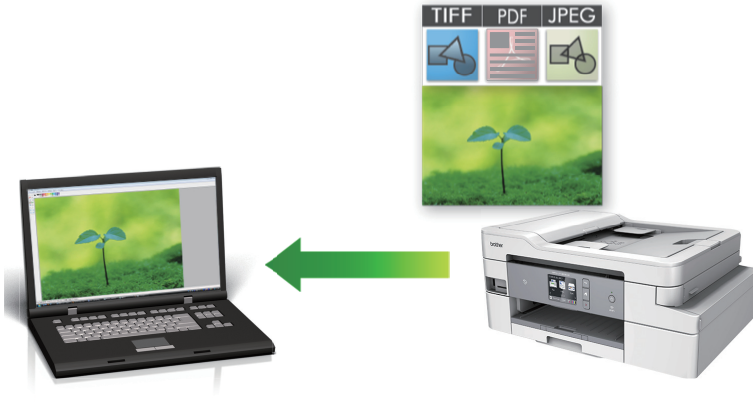

Select **Advanced Mode** as the mode setting for ControlCenter4.

1. Load your document.
2. Click the  (ControlCenter4) icon in the task tray, and then click **Open**.
3. Click the **Scan** tab.



4. Click the **Image** button.  
The scan settings dialog box appears.

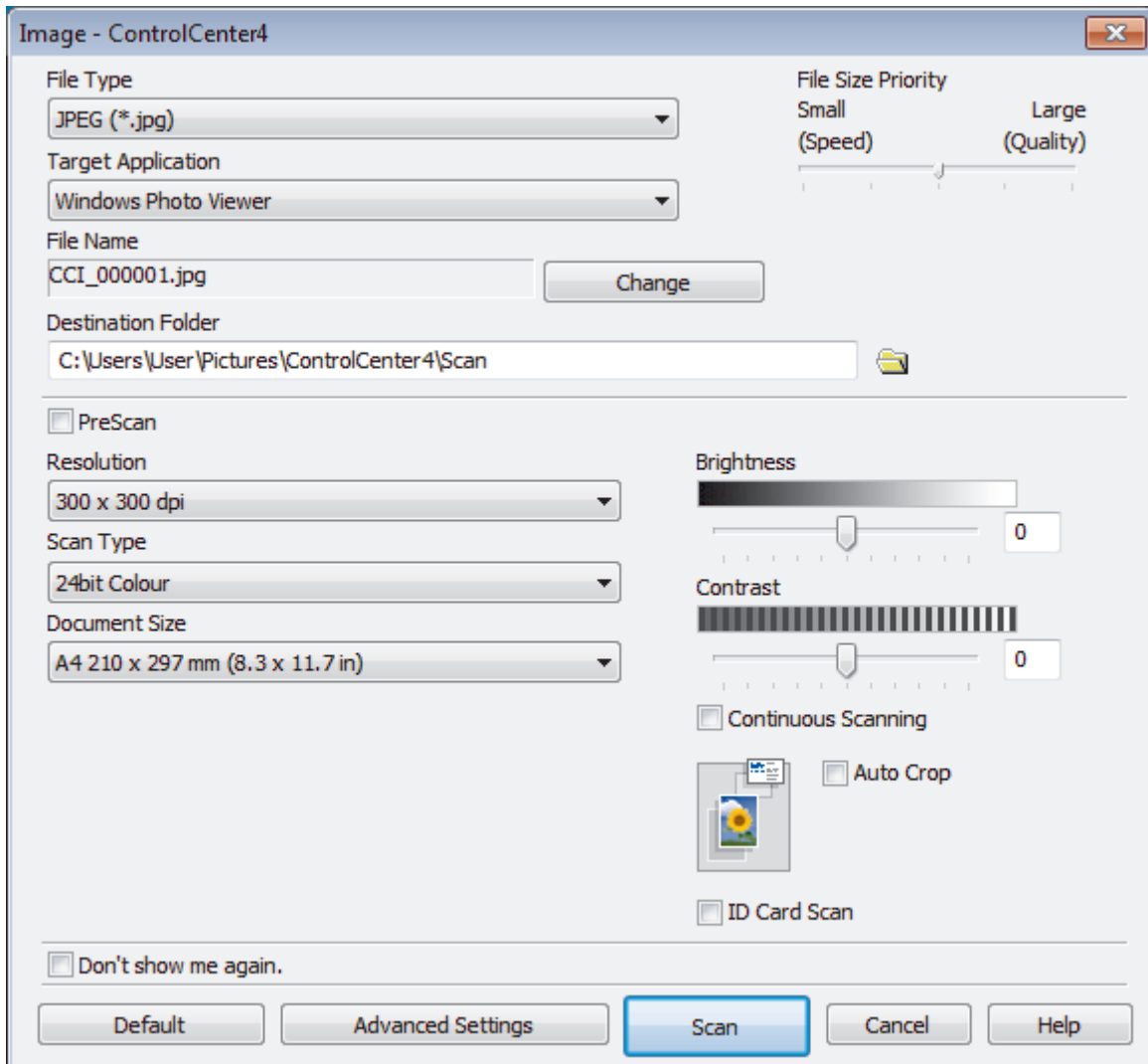

5. Change the scan settings, such as file format, file name, destination folder, resolution and colour, if needed.



- To change the file name, click **Change**.
- To change **Destination Folder**, click the folder icon.
- To preview and configure the scanned image, select the **PreScan** check box.

6. Click **Scan**.

The machine starts scanning. The image opens in the application you have selected.



### Related Information

- [Scan Using ControlCenter4 Advanced Mode \(Windows\)](#)

## Save Scanned Data to a Folder as a PDF File Using ControlCenter4 Advanced Mode (Windows)

Scan documents and save them to a folder on your computer as PDF files.



Select **Advanced Mode** as the mode setting for ControlCenter4.

1. Load your document.
2. Click the  (ControlCenter4) icon in the task tray, and then click **Open**.
3. Click the **Scan** tab.



4. Click the **File** button.

The scan settings dialog box appears.

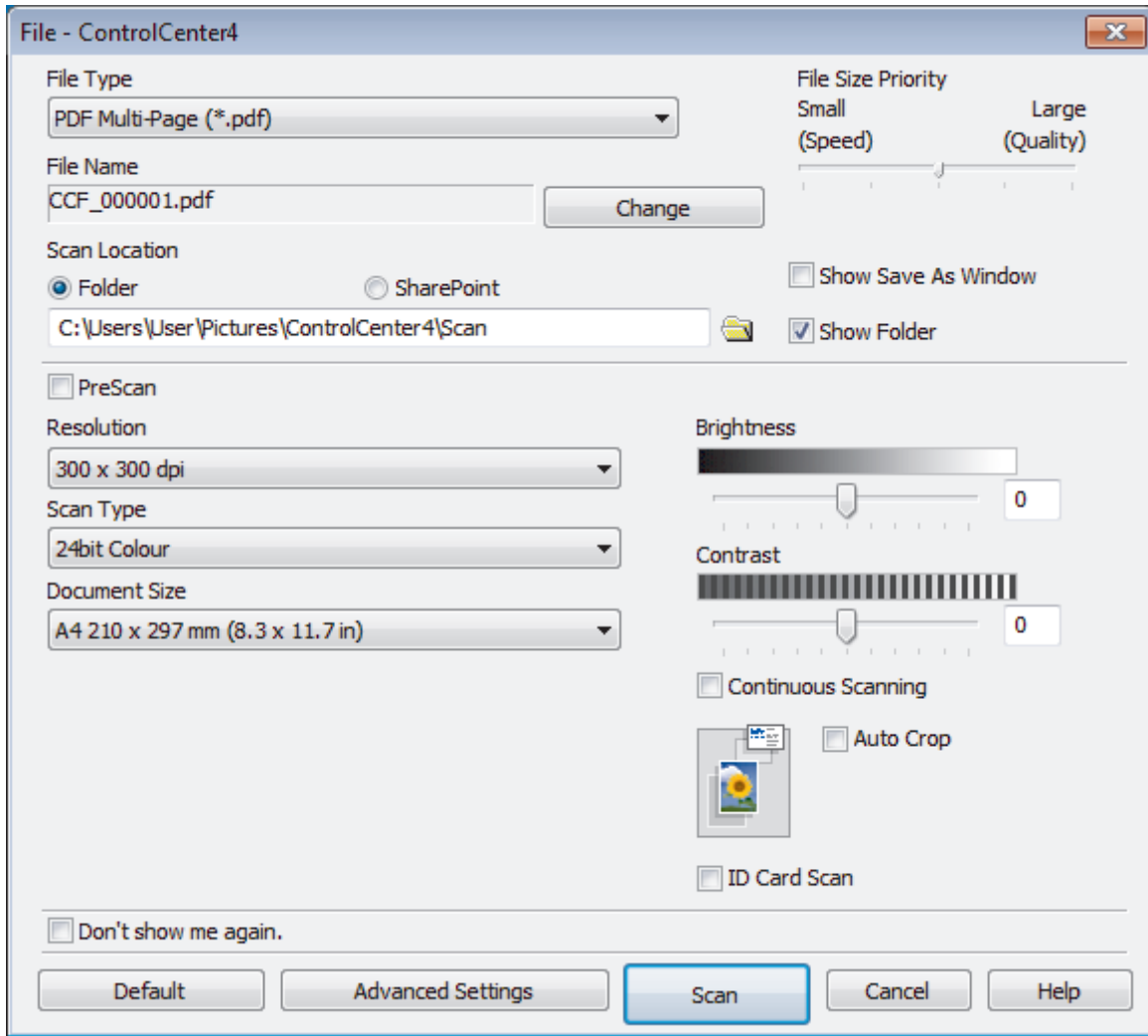

5. Click the **File Type** drop-down list, and then select a PDF file.



To save the document as a password-protected PDF, select **Secure PDF Single-Page (\*.pdf)** or **Secure PDF Multi-Page (\*.pdf)** from the **File Type** drop-down list, click , and then type the password.

6. Click the folder icon to browse and select the folder where you want to save your scanned documents.
7. Change the scan settings, such as file format, file name, resolution and colour, if needed.



To preview and configure the scanned image, select the **PreScan** check box.

8. Click **Scan**.

The machine starts scanning. The file is saved in the folder you selected.



## Related Information

- [Scan Using ControlCenter4 Advanced Mode \(Windows\)](#)



## Scan Both Sides of an ID Card Using ControlCenter4 Advanced Mode (Windows)

Select **Advanced Mode** as the mode setting for ControlCenter4.

1. Place an ID card on the scanner glass.
2. Click the  (ControlCenter4) icon in the task tray, and then click **Open**.
3. Click the **Scan** tab.

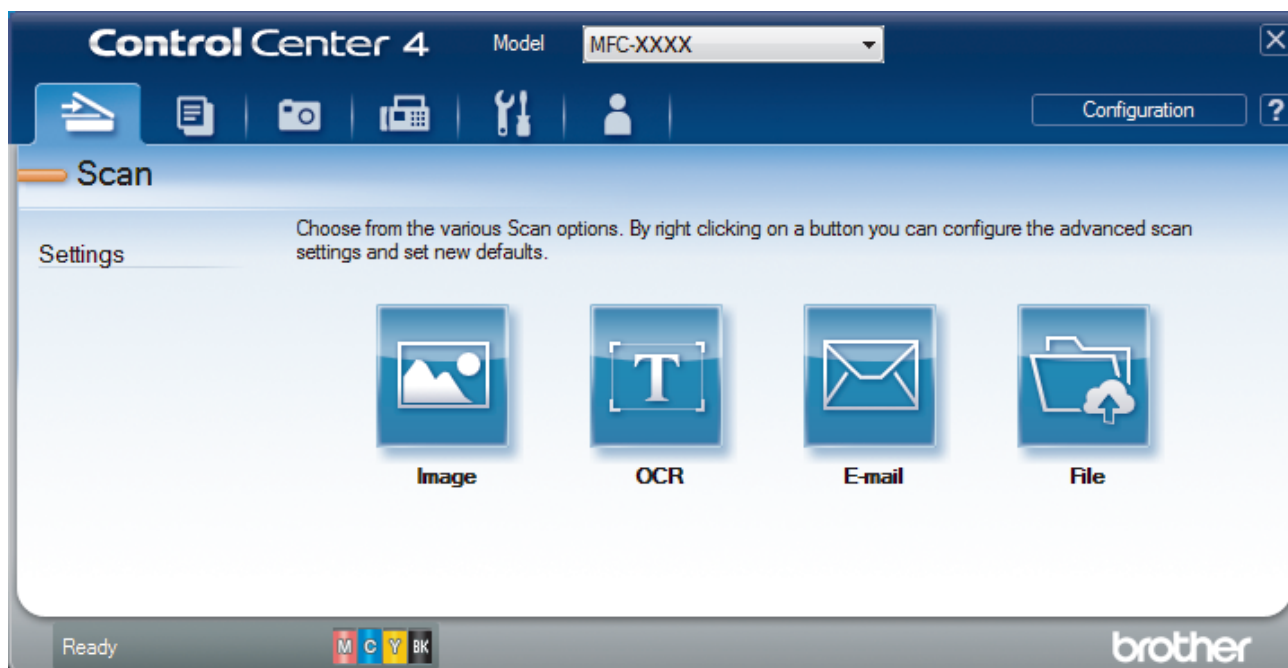

4. Click the **File** button.

The scan settings dialog box appears.

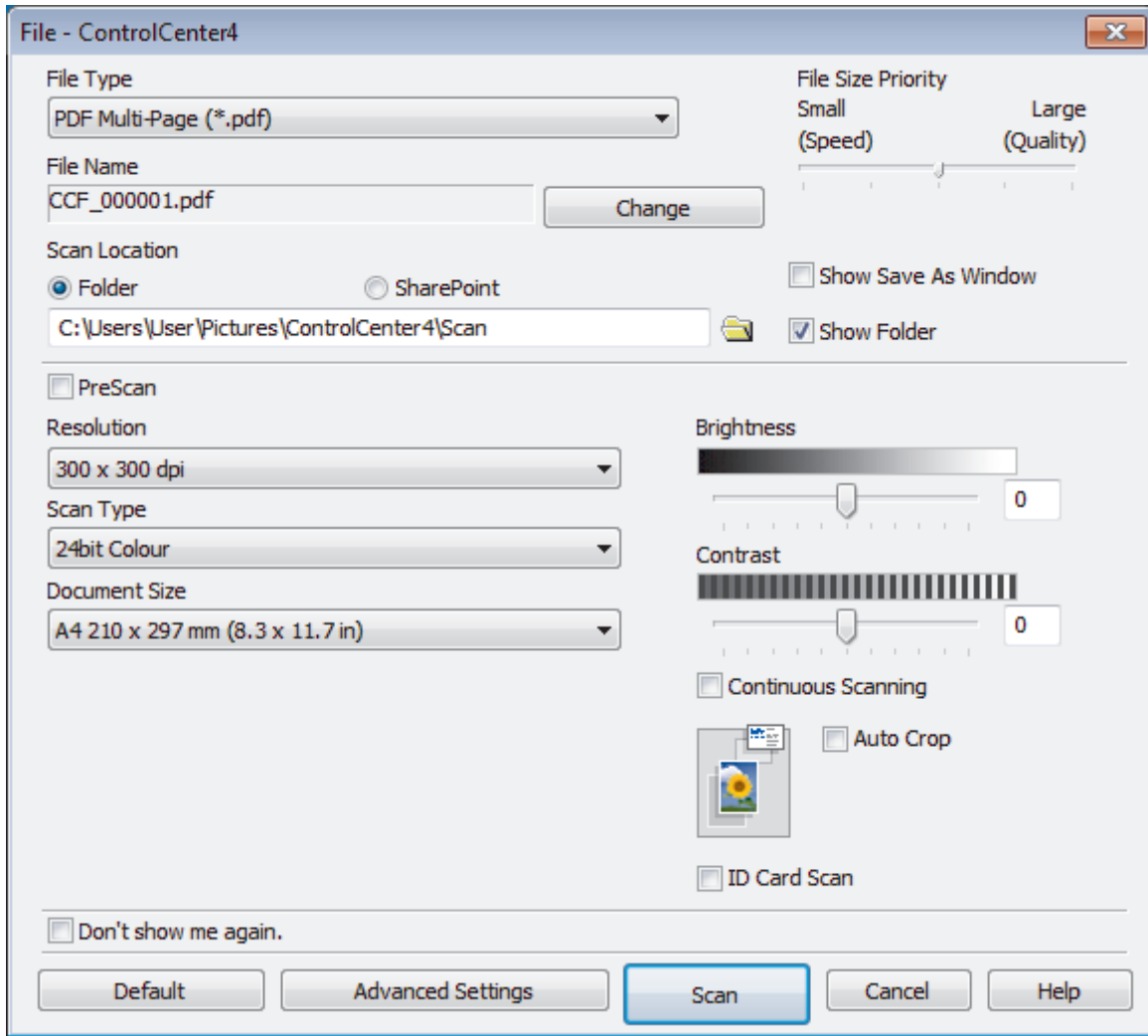

5. Select the **ID Card Scan** check box.

The instruction dialog box appears.

6. Read the instructions on the screen, and then click **OK**.
7. Change the scan settings, such as file format, file name, scan location, resolution and colour, if needed.
8. Click **Scan**.

The machine starts scanning one side of the identification card.

9. After the machine has scanned one side, turn over the identification card, and then click **Continue** to scan the other side.
10. Click **Finish**.



## Related Information

- [Scan Using ControlCenter4 Advanced Mode \(Windows\)](#)

## Scan to Email Attachment Using ControlCenter4 Advanced Mode (Windows)

Send a scanned document as an email attachment.

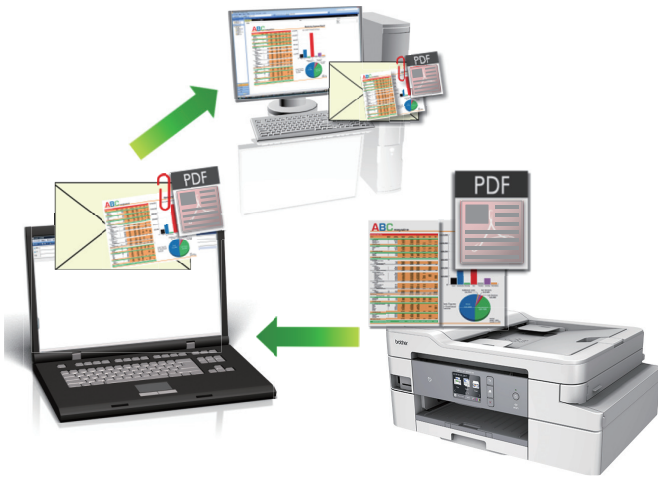

- Select **Advanced Mode** as the mode setting for ControlCenter4.
- The Scan to Email feature does not support Webmail services. Use the Scan to Image or Scan to File feature to scan a document or a picture, and then attach the scanned file to an email message.



The machine scans to your default email application.

1. Load your document.
2. Click the **cc4 (ControlCenter4)** icon in the task tray, and then click **Open**.
3. Click the **Scan** tab.



4. Click the **E-mail** button.  
The scan settings dialog box appears.

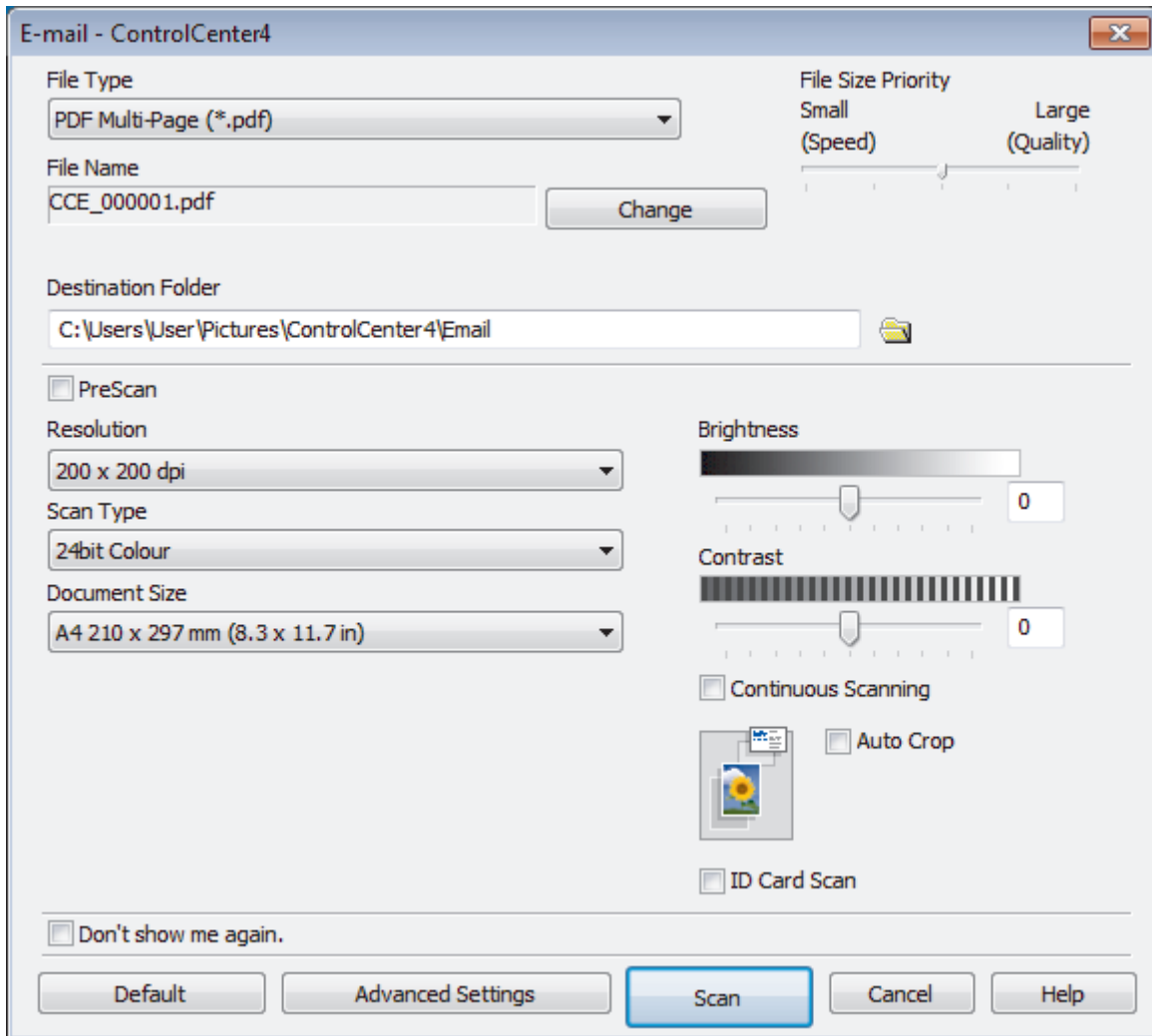

5. Change the scan settings, such as file format, file name, destination folder, resolution and colour, if needed.



- To change the file name, click **Change**.
- To change **Destination Folder**, click the folder icon.
- To preview and configure the scanned image, select the **PreScan** check box.

6. Click **Scan**.

The machine starts scanning. Your default email application opens and the scanned image is attached to a new, blank email message.



### Related Information

- [Scan Using ControlCenter4 Advanced Mode \(Windows\)](#)

## Scan to an Editable Text File (OCR) Using ControlCenter4 Advanced Mode (Windows)

Your machine can convert characters in a scanned document to text using optical character recognition (OCR) technology. You can edit this text using your preferred text-editing application.



- Select **Advanced Mode** as the mode setting for ControlCenter4.

1. Load your document.
2. Click the  (ControlCenter4) icon in the task tray, and then click **Open**.
3. Click the **Scan** tab.



4. Click the **OCR** button.  
The scan settings dialog box appears.

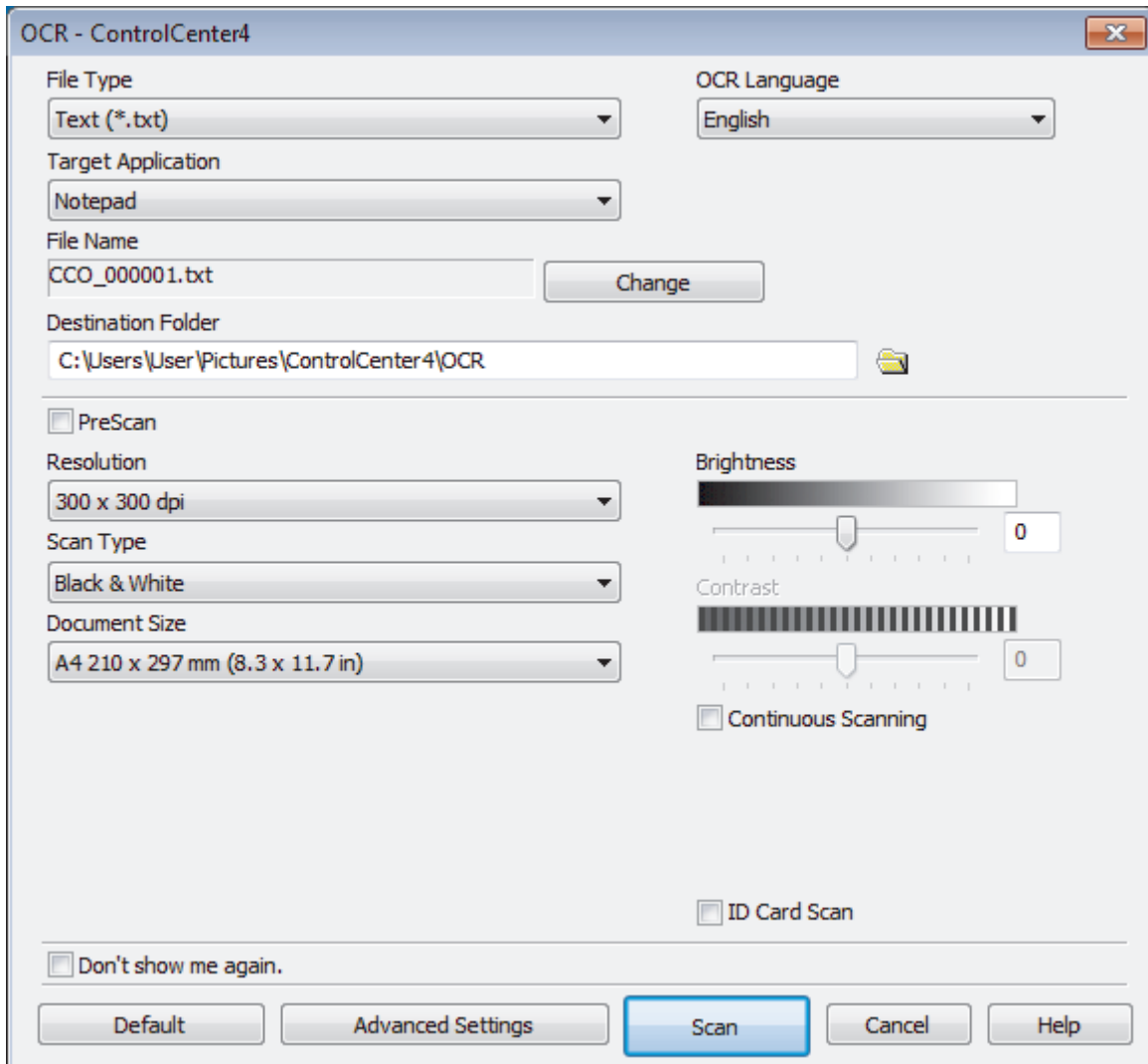

5. Change the scan settings, such as file format, file name, destination folder, resolution and colour, if needed.



- To change the file name, click **Change**.
- To change **Destination Folder**, click the folder icon.
- To preview and configure the scanned image, select the **PreScan** check box.

6. Click **Scan**.

The machine scans the document, converts it to editable text, and then sends it to your default word processing application.



### Related Information

- [Scan Using ControlCenter4 Advanced Mode \(Windows\)](#)

## Scan to an Office File Using ControlCenter4 Advanced Mode (Windows)

Your machine can convert scanned data to a Microsoft Word, Microsoft PowerPoint, or Microsoft Excel file.

- Select **Advanced Mode** as the mode setting for ControlCenter4.
- To use this feature, your computer must be connected to the Internet.

1. Load your document.
2. Click the  (**ControlCenter4**) icon in the task tray, and then click **Open**.
3. Click the **Scan** tab.



4. Click the **E-mail** or **File** button.  
The scan settings dialog box appears.
5. Click the **File Type** drop-down list, and then select the **Microsoft Office Word (\*.docx)**, **Microsoft Office PowerPoint (\*.pptx)**, or **Microsoft Office Excel (\*.xlsx)** option.
6. Change the scan settings, if needed.
7. Click the **Scan** button.  
If a message dialog box regarding the Internet connection appears, read the information and click **OK**.

### ✓ Related Information

- [Scan Using ControlCenter4 Advanced Mode \(Windows\)](#)

## Scan Settings for ControlCenter4 Advanced Mode (Windows)

Settings	Applicable Features			
	Image	OCR	E-mail	File
File Type	Yes	Yes	Yes	Yes
Target Application	Yes	Yes	-	-
OCR Language (Available only for certain models)	-	Yes	-	-
File Name	Yes	Yes	Yes	Yes
Destination Folder	Yes	Yes	Yes	-
Scan Location	-	-	-	Yes
Show Folder	-	-	-	Yes
Show Save As Window	-	-	-	Yes
File Size Priority	Yes	-	Yes	Yes
PreScan	Yes	Yes	Yes	Yes
Resolution	Yes	Yes	Yes	Yes
Scan Type	Yes	Yes	Yes	Yes
Document Size	Yes	Yes	Yes	Yes
Brightness	Yes	Yes	Yes	Yes
Contrast	Yes	Yes	Yes	Yes
Continuous Scanning	Yes	Yes	Yes	Yes
Auto Crop	Yes	-	Yes	Yes
ID Card Scan	Yes	Yes	Yes	Yes
Advanced Settings	Yes	Yes	Yes	Yes
Default	Yes	Yes	Yes	Yes

### File Type

Select the file type you want to use for the scanned data.

For **Image**, **E-mail** and **File**:

- **Windows Bitmap (\*.bmp)**
- **JPEG (\*.jpg)** (recommended for most users when scanning pictures)
- **TIFF Single-Page (\*.tif)**
- **TIFF Multi-Page (\*.tif)**
- **Portable Network Graphics (\*.png)**
- **PDF Single-Page (\*.pdf)** (recommended for scanning and sharing documents)
- **PDF Multi-Page (\*.pdf)** (recommended for scanning and sharing documents)
- **High Compression PDF Single-Page (\*.pdf)**
- **High Compression PDF Multi-Page (\*.pdf)**
- **Secure PDF Single-Page (\*.pdf)**
- **Secure PDF Multi-Page (\*.pdf)**
- **Searchable PDF Single-Page (\*.pdf)**
- **Searchable PDF Multi-Page (\*.pdf)**
- **XML Paper Specification (\*.xps)** (the XML Paper Specification is available for Windows 7, Windows 8, and Windows 10, or when using applications that support XML Paper Specification files)



---

For **OCR**:

- **Text (\*.txt)**
- **HTML 3.2 (\*.htm)**
- **HTML 4.0 (\*.htm)**
- **Searchable PDF Single-Page (\*.pdf)**
- **Searchable PDF Multi-Page (\*.pdf)**
- **WordPad (\*.rtf)**
- **RTF Word 2000 (\*.rtf)**
- **WordPerfect 9, 10 (\*.wpd)**
- **Microsoft Excel 2003, XP (\*.xls)**

For **E-mail** and **File**:

- **Microsoft Office Word (\*.docx)** (Available only for certain models)
- **Microsoft Office PowerPoint (\*.pptx)** (Available only for certain models)
- **Microsoft Office Excel (\*.xlsx)** (Available only for certain models)

### Target Application

Select the destination application from the drop-down list.

### OCR Language

Set the optical character recognition (OCR) language to match the language of the scanned document's text (Available only for certain models).

### File Name

Click **Change** to change the file name's prefix.

### Destination Folder

Click the folder icon to browse and select the folder where you want to save your scanned documents.

### Scan Location

Select the **Folder** or **SharePoint** radio button to specify the destination where you want to save your scanned documents.

### Show Folder

Select this option to automatically display the destination folder after scanning.

### Show Save As Window

Select this option to specify the scanned image's destination every time you scan.

### File Size Priority

Adjust the data compression ratio of the scanned image. Change the file size by moving the **File Size Priority** slider to the right or left.

### PreScan

Select **PreScan** to preview your image and crop unwanted portions before scanning.

### Resolution

Select a scanning resolution from the **Resolution** drop-down list. Higher resolutions take more memory and transfer time, but produce a finer scanned image.

### Scan Type

Select from a range of scan colour depths.

- **Auto**  
Use for any type of document. This mode automatically picks an appropriate colour depth for the document.
- **Black & White**  
Use for text or line art images.

- 
- **Grey (Error Diffusion)**  
Use for photographic images or graphics. (Error Diffusion is a method for creating simulated grey images without using true grey dots. Black dots are put in a specific pattern to give a grey appearance.)
  - **True Grey**  
Use for photographic images or graphics. This mode is more accurate because it uses up to 256 shades of grey.
  - **24bit Colour**  
Use to create an image with the most accurate colour reproduction. This mode uses up to 16.8 million colours to scan the image, but it requires the most memory and has the longest transfer time.

### Document Size

Select the exact size of your document from the **Document Size** drop-down list.

- If you select the **1 to 2 (A4)** option, the scanned image will be divided into two A5-size documents.

### Brightness

Set the **Brightness** level by dragging the slider to the right or left to lighten or darken the image. If the scanned image is too light, set a lower brightness level and scan the document again. If the image is too dark, set a higher brightness level and scan the document again. You can also type a value into the field to set the **Brightness** level.

### Contrast

Increase or decrease the **Contrast** level by moving the slider to the right or left. An increase emphasises dark and light areas of the image, while a decrease reveals more details in grey areas. You can also type a value into the field to set the **Contrast** level.

### Continuous Scanning

Select this option to scan multiple pages. After a page is scanned, select either continue scanning or finish.

### Auto Crop

Scan multiple documents placed on the scanner glass. The machine will scan each document and create separate files or a single multi-page file.

### ID Card Scan

Select this check box to scan both sides of an identification card onto one page.

### Advanced Settings

Configure advanced settings by clicking the **Advanced Settings** button in the scan settings dialog box.

- **Remove Bleed-through / Pattern**
  - **Remove Background Colour**  
Remove the base colour of documents to make the scanned data more legible.
- **Rotate Image**  
Rotate the scanned image.
- **Skip Blank Page**  
Remove the document's blank pages from the scanning results. (Available only for certain models)
- **Display Scanning Results**  
Show on your computer screen the number of total pages saved, and blank pages skipped. (Available only for certain models)

### ADF Auto Deskew

Set the machine to automatically correct a skewed document. (Available only for certain models)

### Default

Select this option to restore all settings to their factory setting values.



## Related Information

- [Scan Using ControlCenter4 Advanced Mode \(Windows\)](#)
-



## Scan Using Nuance™ PaperPort™ 14SE or Other Windows Applications

You can use the Nuance™ PaperPort™ 14SE application for scanning.

- To download the Nuance™ PaperPort™ 14SE application, click  (**Brother Utilities**), select **Do More** in the left navigation bar, and then click **PaperPort**.
- Nuance™ PaperPort™ 14SE supports Windows 7, Windows 8, Windows 8.1, Windows 10 Home, Windows 10 Pro, Windows 10 Education and Windows 10 Enterprise.
- For detailed instructions on using each application, click the application's **Help** menu, and then click **Getting Started Guide** in the **Help** ribbon.



The instructions for scanning in these steps are for PaperPort™ 14SE. For other Windows applications, the steps will be similar. PaperPort™ 14SE supports both TWAIN and WIA drivers; the TWAIN driver (recommended) is used in these steps.

- Depending on the model of your machine, Nuance™ PaperPort™ 14SE may not be included. If it is not included, you can use other software applications that support scanning.
1. Load your document.
  2. Start PaperPort™ 14SE.  
Do one of the following:
    - Windows 7  
Using your computer, click  (**Start**) > **All Programs** > **Nuance PaperPort 14** > **PaperPort**.
    - Windows 8  
Click  (**PaperPort**).
    - Windows 10  
Click  > **Nuance PaperPort 14** > **PaperPort**.
  3. Click the **Desktop** menu, and then click **Scan Settings** in the **Desktop** ribbon.  
The **Scan or Get Photo** panel appears on the left side of the screen.
  4. Click **Select**.
  5. From the available Scanners list, select **TWAIN: TW-Brother MFC-XXXX** or **TWAIN: TW-Brother MFC-XXXX LAN** (where MFC-XXXX is the model name of your machine). To use the WIA driver, select the Brother driver that has "WIA" as the prefix.
  6. Select the **Display scanner dialog box** check box in the **Scan or Get Photo** panel.
  7. Click **Scan**.  
The Scanner Setup dialog box appears.

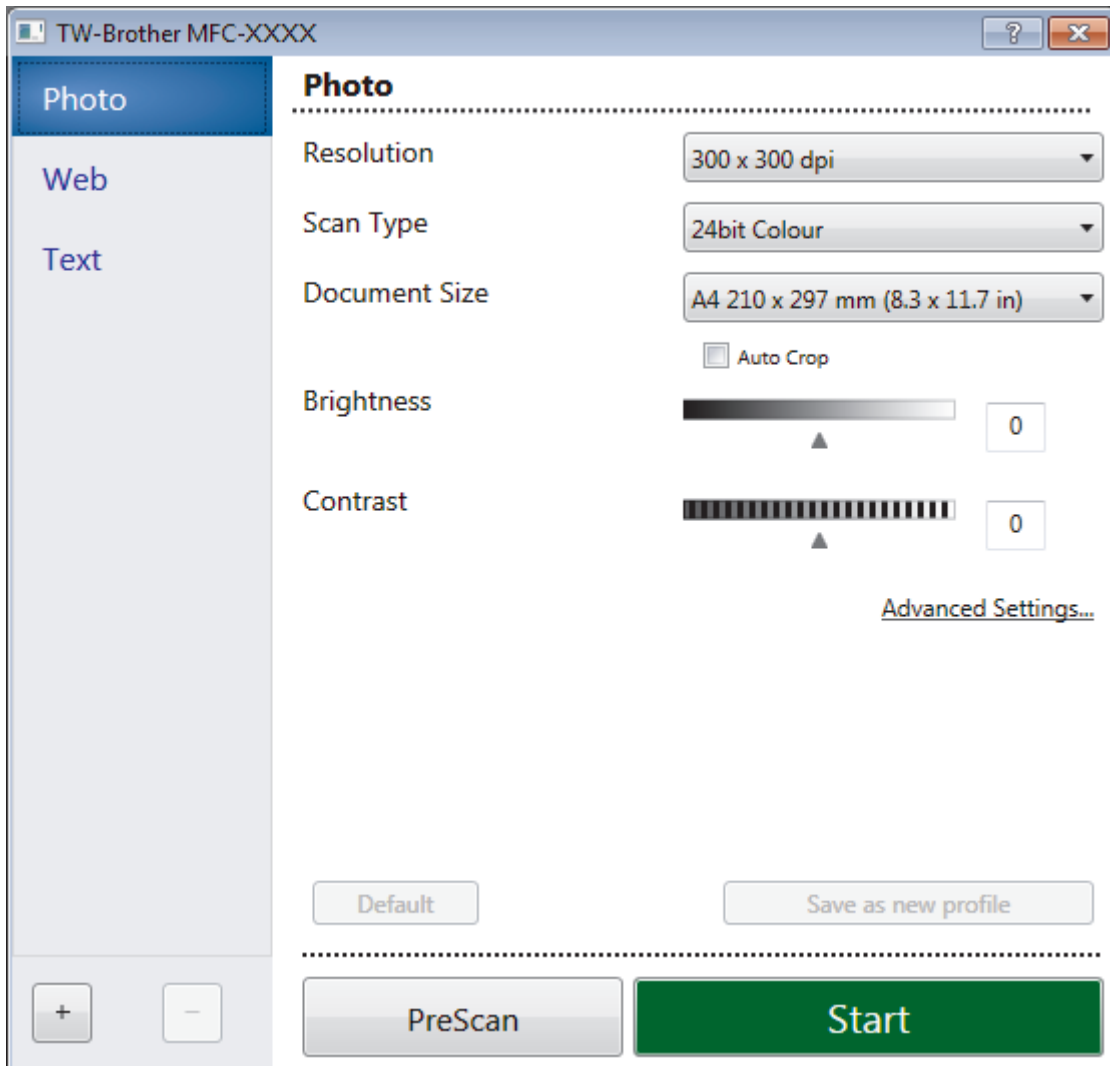

8. Adjust the settings in the Scanner Setup dialog box, if needed.
9. Click the **Document Size** drop-down list, and then select your document size.
10. Click **PreScan** if you want to preview your image and crop unwanted portions before scanning.
11. Click **Start**.

The machine starts scanning.

### ✓ Related Information

- [Scan from Your Computer \(Windows\)](#)
  - [TWAIN Driver Settings \(Windows\)](#)

## TWAIN Driver Settings (Windows)

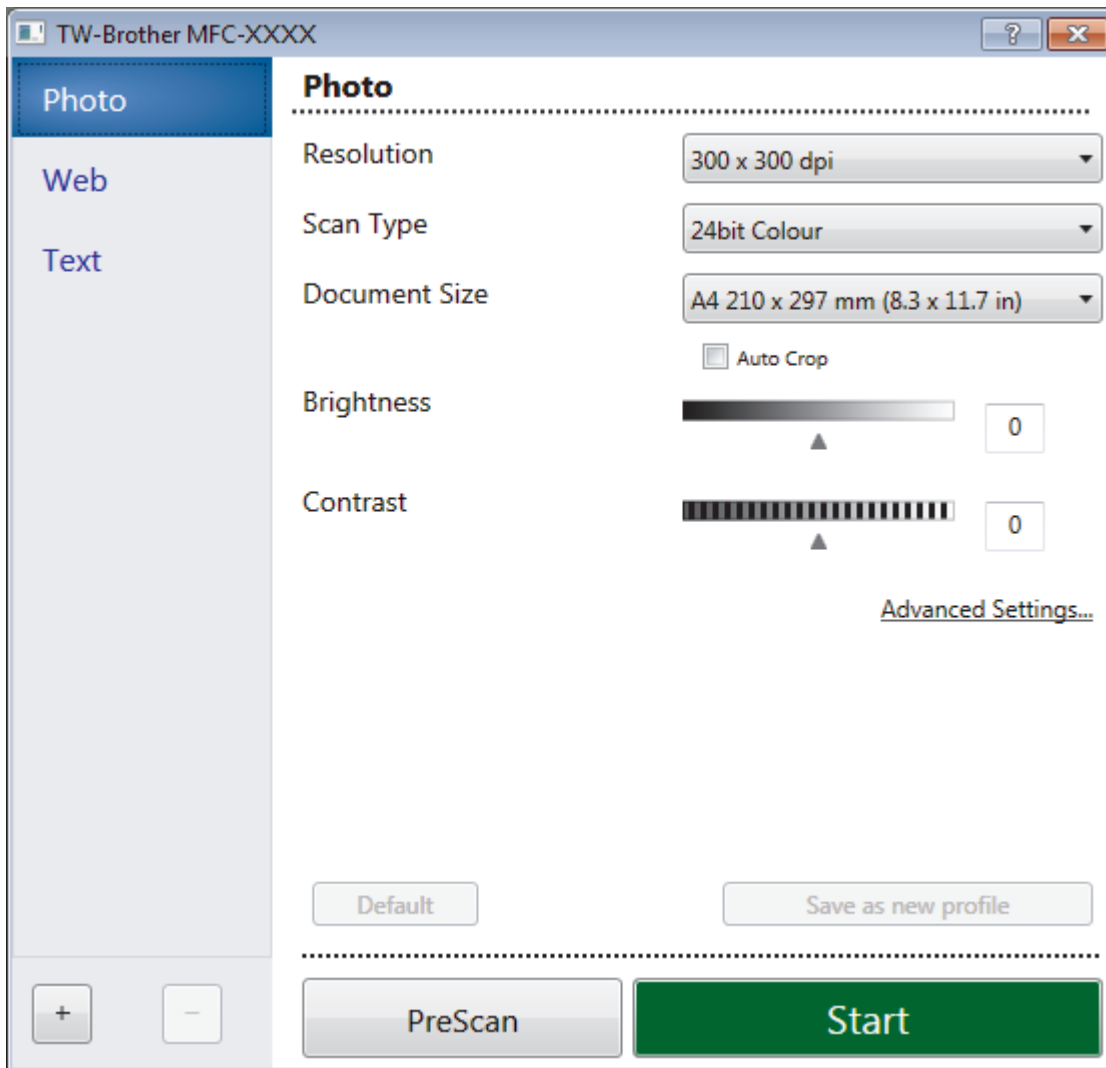

 Note that the item names and assignable values will vary depending on the machine.

### 1. Scan

Select the **Photo**, **Web**, or **Text** option depending on the type of document you want to scan.

Scan (Image Type)		Resolution	Scan Type
<b>Photo</b>	Use for scanning photo images.	300 x 300 dpi	<b>24bit Colour</b>
<b>Web</b>	Use for attaching the scanned image to web pages.	100 x 100 dpi	<b>24bit Colour</b>
<b>Text</b>	Use for scanning text documents.	200 x 200 dpi	<b>Black &amp; White</b>

### 2. Resolution

Select a scanning resolution from the **Resolution** drop-down list. Higher resolutions take more memory and transfer time, but produce a finer scanned image.

### 3. Scan Type

Select from a range of scan colour depths.

- **Black & White**

Use for text or line art images.

- **Grey (Error Diffusion)**

Use for photographic images or graphics. (Error Diffusion is a method for creating simulated grey images without using true grey dots. Black dots are put in a specific pattern to give a grey appearance.)

- **True Grey**

Use for photographic images or graphics. This mode is more accurate because it uses up to 256 shades of grey.

- **24bit Colour**

Use to create an image with the most accurate colour reproduction. This mode uses up to 16.8 million colours to scan the image, but it requires the most memory and has the longest transfer time.

#### 4. Document Size

Select the exact size of your document from a selection of preset scan sizes.

If you select **Custom**, the **Custom Document Size** dialog box appears and you can specify the document size.

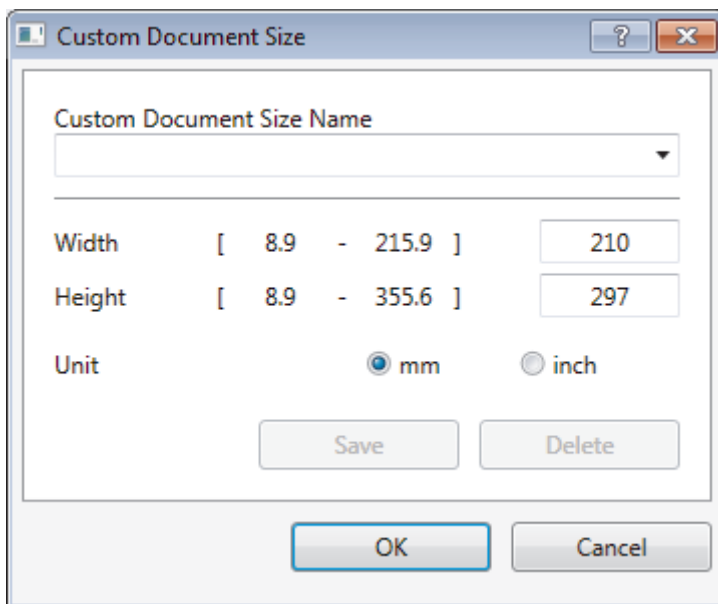

#### 5. Brightness

Set the **Brightness** level by dragging the slider to the right or left to lighten or darken the image. If the scanned image is too light, set a lower brightness level and scan the document again. If the image is too dark, set a higher brightness level and scan the document again. You can also type a value in the field to set the brightness level.

#### 6. Contrast

Increase or decrease the **Contrast** level by moving the slider to the right or left. An increase emphasises dark and light areas of the image, while a decrease reveals more details in grey areas. You can also type a value in the field to set the contrast level.

#### 7. Auto Crop

Scan multiple documents placed on the scanner glass. The machine will scan each document and create separate files or a single multi-page file.

#### 8. Advanced Settings

Configure advanced settings by clicking the **Advanced Settings** link in the Scanner Setup dialog box.

- **Paper**

- **Auto Deskew**

Set the machine to correct document skewing automatically as the pages are scanned from the ADF.

- **Rotate Image**

Rotate the scanned image.

- **Enhancement**

- **Background Processing**

- 
- **Remove Bleed-through / Pattern**  
Prevent bleed-through.
  - **Remove Background Colour**  
Remove the base colour of documents to make the scanned data more legible.
  - **Colour Drop**  
Select a colour to remove from the scanned image.
  - **Boldface Formatting**  
Emphasise the characters of the original by making them bold.
  - **Blurred Character Correction**  
Correct the broken or incomplete characters of the original to make them easier to read.
  - **Edge Emphasis**  
Make the characters of the original sharper.
  - **Reduce Noise**  
Improve and enhance the quality of your scanned images with this selection. The **Reduce Noise** option is available when selecting the **24bit Colour** option and the **300 x 300 dpi**, **400 x 400 dpi**, or **600 x 600 dpi** scan resolution.
  - **Paper Handling**
    - **Edge Fill**  
Fill in the edges on four sides of the scanned image using the selected colour and range.
    - **Skip Blank Page**  
Remove the document's blank pages from the scanning results. (Available only for certain models)
    - **Continuous Scan**  
Select this option to scan multiple pages. After a page is scanned, select either continue scanning or finish.



## Related Information

- [Scan Using Nuance™ PaperPort™ 14SE or Other Windows Applications](#)
-



## Scan Using Windows Fax and Scan

Windows Fax and Scan application is another option that you can use for scanning.

- Windows Fax and Scan uses the WIA scanner driver.
- If you want to crop a portion of a page after pre-scanning the document, you must scan using the scanner glass (also called the flatbed).

1. Load your document.
2. Launch Windows Fax and Scan.
3. Click **File > New > Scan**.
4. Select the scanner you want to use.
5. Click **OK**.

The **New Scan** dialog box appears.

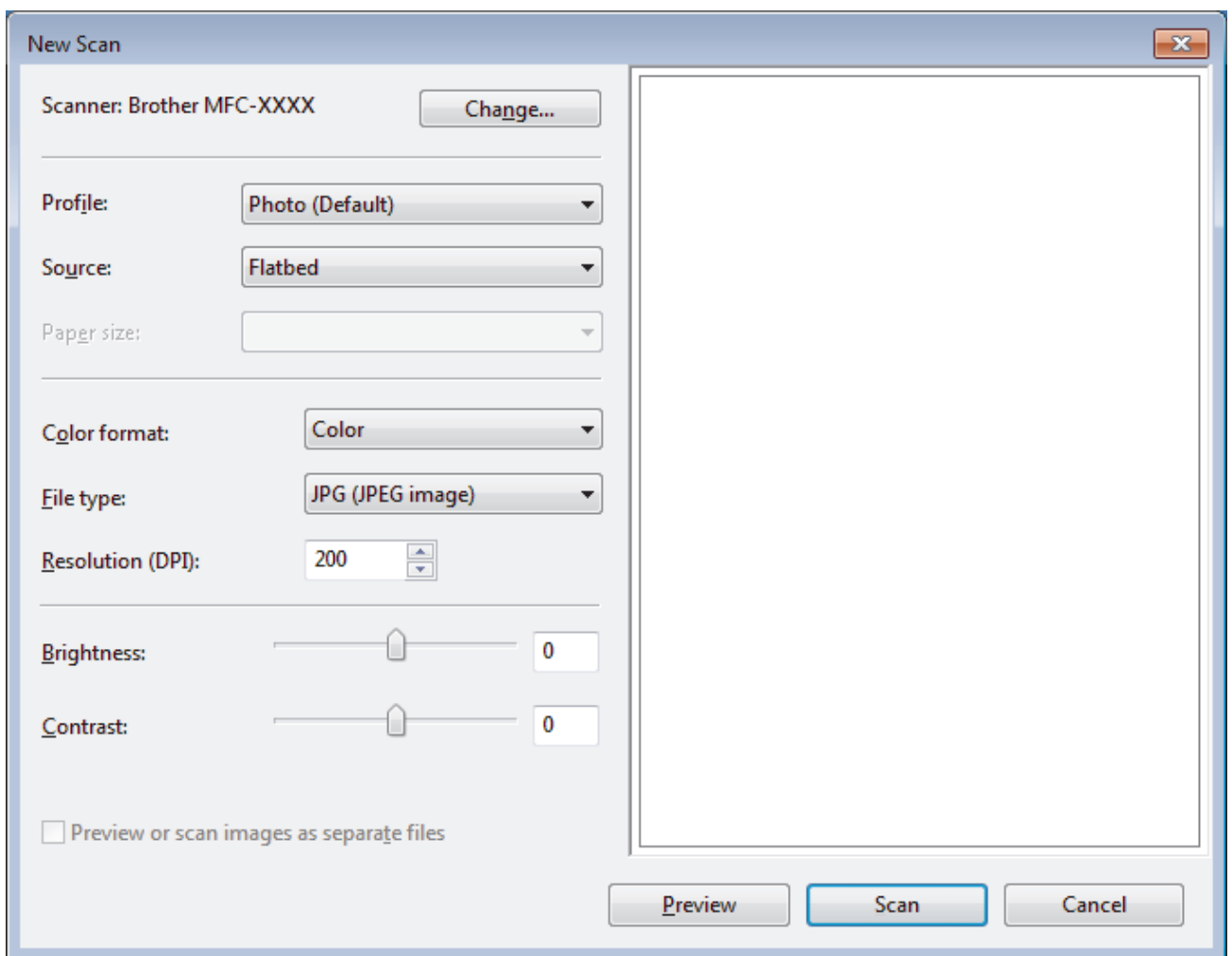

6. Adjust the settings in the Scanner Setup dialog box, if needed.  
The scanner resolution can be set to a maximum of 1200 dpi. If you want to scan at higher resolutions, use the **Scanner Utility** software from **Brother Utilities**.
7. Click **Scan**.  
The machine starts scanning the document.

### ✓ Related Information

- [Scan from Your Computer \(Windows\)](#)

- 
- WIA Driver Settings (Windows)
-

## WIA Driver Settings (Windows)

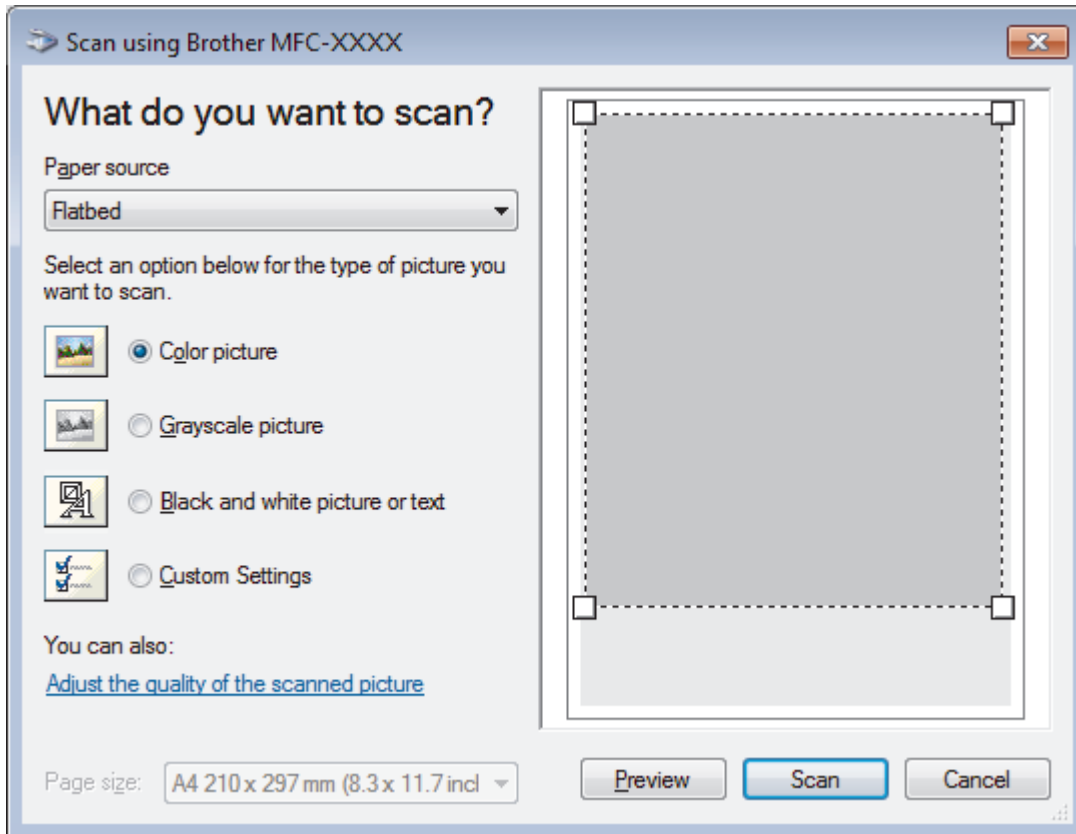

### Paper source

Select the **Document Feeder** or **Flatbed** option from the drop-down list.

### Picture Type (Image Type)

Select **Color picture**, **Grayscale picture**, **Black and white picture or text**, or **Custom Settings** for the type of document you want to scan.

To change advanced settings, click the **Adjust the quality of the scanned picture** link.

### Page size

The **Page size** option is available if you select the **Document Feeder** as the **Paper source** option.

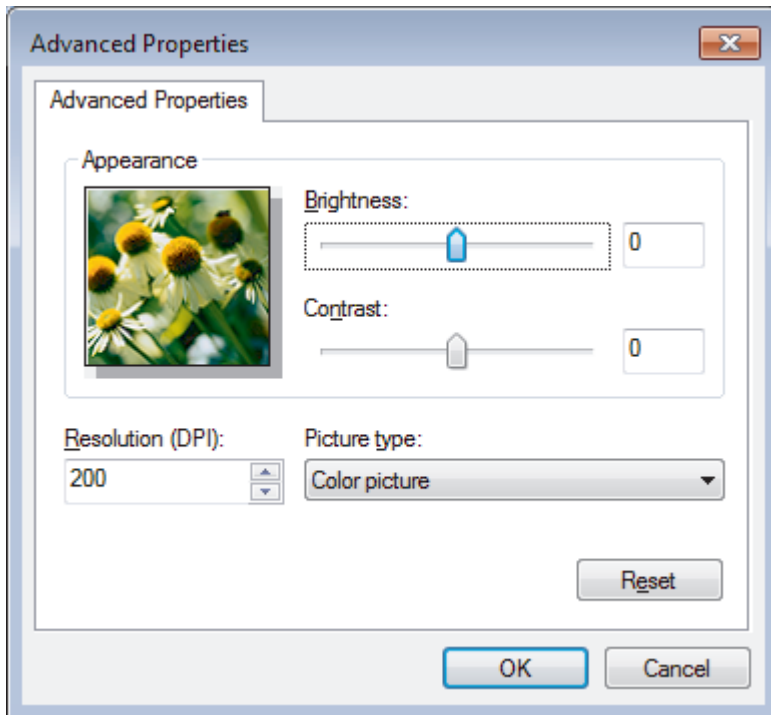

### Brightness

Set the **Brightness** level by dragging the slider to the right or left to lighten or darken the image. If the scanned image is too light, set a lower brightness level and scan the document again. If the image is too dark, set a higher brightness level and scan the document again.

### Contrast

Increase or decrease the **Contrast** level by moving the slider to the right or left. An increase emphasises dark and light areas of the image, while a decrease reveals more details in grey areas. You can also type a value in the field to set the contrast level.

### Resolution (DPI)

Select a scanning resolution from the **Resolution (DPI)** list. Higher resolutions take more memory and transfer time, but produce a finer scanned image.

## ✓ Related Information

- [Scan Using Windows Fax and Scan](#)

## Install BookScan Enhancer and Whiteboard Enhancer (Windows)

BookScan Enhancer and Whiteboard Enhancer are image processing applications. BookScan Enhancer can automatically correct images scanned from books. Whiteboard Enhancer can clean up and enhance text and images in photos taken of a whiteboard.

These applications are not available for Windows Server series.

- The machine must be turned on and connected to the computer.
- The computer must be connected to the Internet.
- You must be logged on with Administrator access privileges.

1. Click  (**Brother Utilities**).
2. Select your machine from the drop-down list.
3. Select **Do More** in the left navigation bar.
4. Click **BookScan&WhiteBoard Suite** and follow the on-screen instructions to install.



### Related Information

- [Scan from Your Computer \(Windows\)](#)

## Scan from Your Computer (Mac)

There are several ways you can use your Mac to scan photos and documents on your Brother machine. Use the software applications provided by Brother or your favourite scanning application.

- [Scan Using Brother iPrint&Scan \(Mac\)](#)
- [Scan Using TWAIN-Compliant Applications \(Mac\)](#)
- [Scan Using AirPrint \(macOS\)](#)

## Scan Using Brother iPrint&Scan (Mac)

1. In the **Finder** menu bar, click **Go > Applications**, and then double-click the iPrint&Scan icon.  
The Brother iPrint&Scan screen appears.
2. If your Brother machine is not selected, click the **Select your Machine** button, and then follow the on-screen instructions to select your Brother machine.
3. Click the **Scan** icon, and then follow the on-screen instructions to scan your documents.



### Related Information

- [Scan from Your Computer \(Mac\)](#)

#### Related Topics:

- [Brother iPrint&Scan for Windows and Mac](#)
  - [Change Scan Button Settings from Brother iPrint&Scan \(Mac\)](#)
-

## Scan Using TWAIN-Compliant Applications (Mac)

You can also scan using TWAIN-compliant applications. For more information about the scanning procedure, see the manual for your application.

To use Brother TWAIN Driver, go to your model's **Downloads** page on the Brother Solutions Center at [support.brother.com](http://support.brother.com) and download **Scanner Driver (TWAIN)**.

1. Start your graphics application, and then select the scan operation.  
The scanner setup dialog box appears.

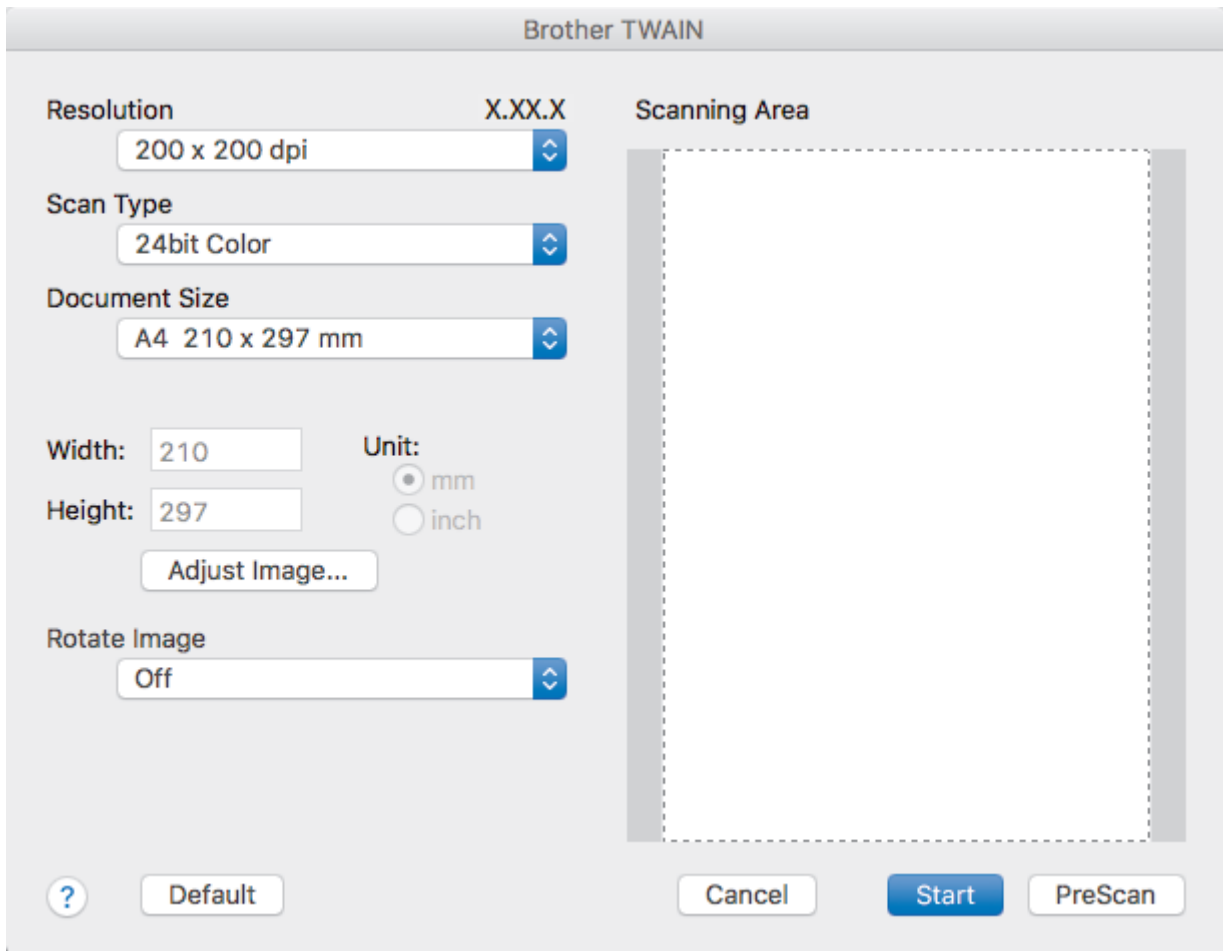

2. Change the scan settings, such as **Resolution**, **Scan Type**, or **Adjust Image**, if needed.
3. Click the **Document Size** pop-up menu, and then select your document size.
4. Click the **PreScan** option to preview your image and crop unwanted portions before scanning.



- After you select a document size, adjust the scanning area by holding down the mouse button and dragging your mouse pointer over the portion you want to scan.

5. Click **Start**.  
The machine starts scanning.

### ✓ Related Information

- [Scan from Your Computer \(Mac\)](#)
  - [TWAIN Driver Settings \(Mac\)](#)



## TWAIN Driver Settings (Mac)

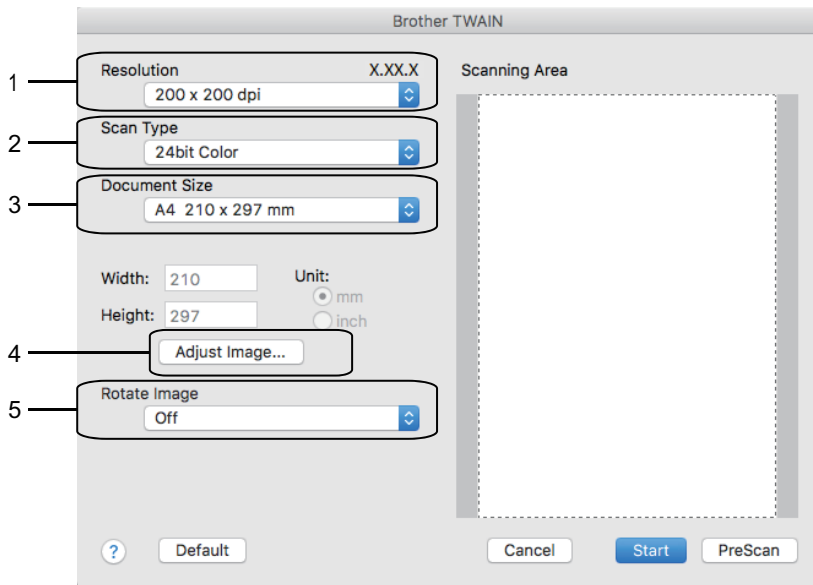

- Item names and assignable values will vary depending on the machine.
- The **Contrast** setting is available only when selecting **Gray (Error Diffusion)**, **True Gray**, or **24bit Color** from the **Scan Type** options.

### 1. Resolution

Select a scanning resolution from the **Resolution** pop-up menu. Higher resolutions take more memory and transfer time, but produce a finer scanned image.

### 2. Scan Type

Select from a range of scan colour depths.

- **Black & White**  
Use for text or line art images.
- **Gray (Error Diffusion)**  
Use for photographic images or graphics. (Error Diffusion is a method for creating simulated grey images without using true grey dots. Black dots are put in a specific pattern to give a grey appearance.)
- **True Gray**  
Use for photographic images or graphics. This mode is more accurate because it uses up to 256 shades of grey.
- **24bit Color**  
Use to create an image with the most accurate colour reproduction. This mode uses up to 16.8 million colours to scan the image, but it requires the most memory and has the longest transfer time.

### 3. Document Size

Select the exact size of your document from a selection of preset scan sizes.

- If you select **Custom**, you can specify the document size.

#### 4. Adjust Image

Click the **Adjust Image** button to adjust other image qualities.

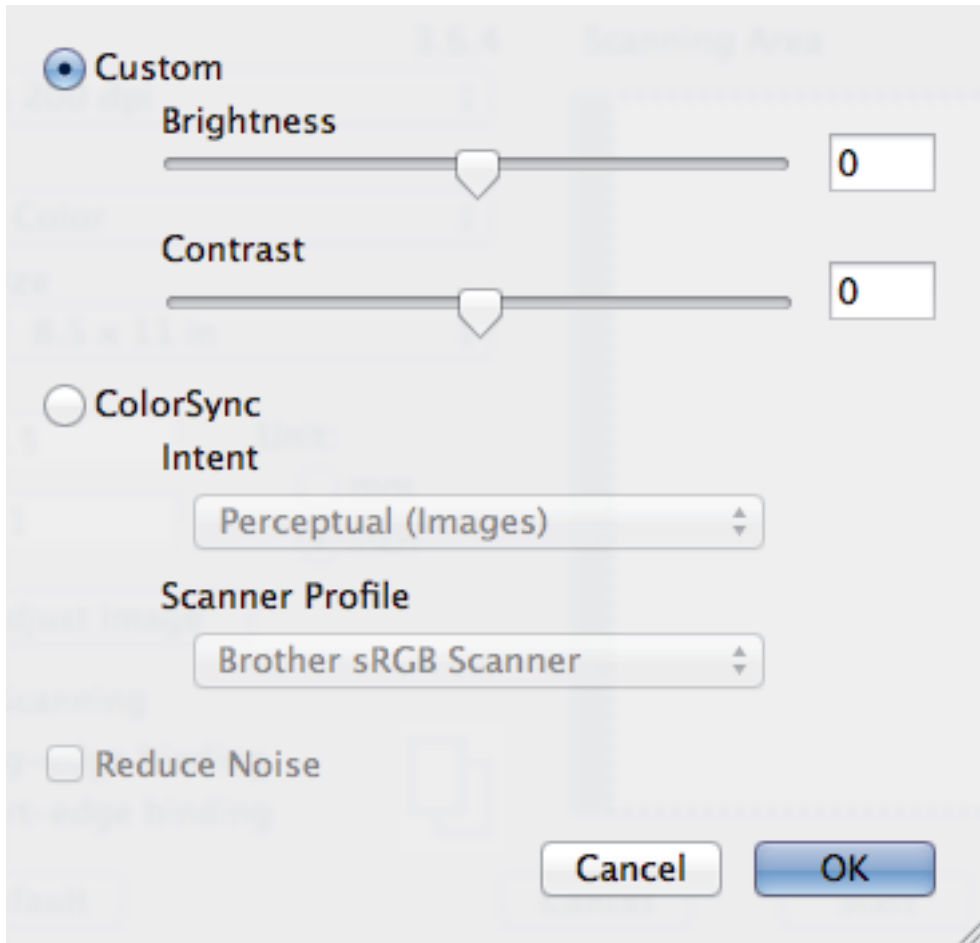

##### Brightness

Set the **Brightness** level by dragging the slider to the right or left to lighten or darken the image. If the scanned image is too light, set a lower brightness level and scan the document again. If the image is too dark, set a higher brightness level and scan the document again. You can also type a value in the box to set the brightness.

##### Contrast

Increase or decrease the **Contrast** level by moving the slider to the right or left. An increase emphasises dark and light areas of the image, while a decrease reveals more details in grey areas. You can also type a value in the box to set the contrast.

##### Reduce Noise

Improve and enhance the quality of your scanned images with this selection. The **Reduce Noise** option is available when selecting the **24bit Color** option and the **300 x 300 dpi**, **400 x 400 dpi**, or **600 x 600 dpi** scan resolutions.

#### 5. Rotate Image

Rotate the scanned image.



#### Related Information

- [Scan Using TWAIN-Compliant Applications \(Mac\)](#)

## Configure Scan Settings Using Web Based Management

- [Set the Scan Job Email Report Using Web Based Management](#)

## Set the Scan Job Email Report Using Web Based Management

When you scan a document, the machine will send a scan job email report automatically to the registered email address.

1. Start your web browser.

Type "https://machine's IP address" in your browser's address bar (where "machine's IP address" is the IP address of the machine or the print server name). For example: https://192.168.1.2

If the machine prompts you for a password, type it, and then click .

2. Click the **Scan** tab.
3. Click the **Scan Job e-mail report** menu in the left navigation bar.
4. In the **Administrator Address** field, type the email address.
5. For the scan functions you want, select **On** to send a scan job email report.
6. Click **Submit**.



### Related Information

- [Configure Scan Settings Using Web Based Management](#)

## Copy

- [Copy a Document](#)
- [Enlarge or Reduce Copied Images](#)
- [Sort Copies](#)
- [Make Page Layout Copies \( N in 1 or Poster\)](#)
- [Copy on Both Sides of the Paper \(2-sided Copy\)](#)
- [Copy an ID Card](#)
- [Copy in Ink Save Mode](#)
- [Copy Options](#)

## Copy a Document

1. Make sure you have loaded the correct size paper in the paper tray.
2. Load your document.
3. Press  [Copy].

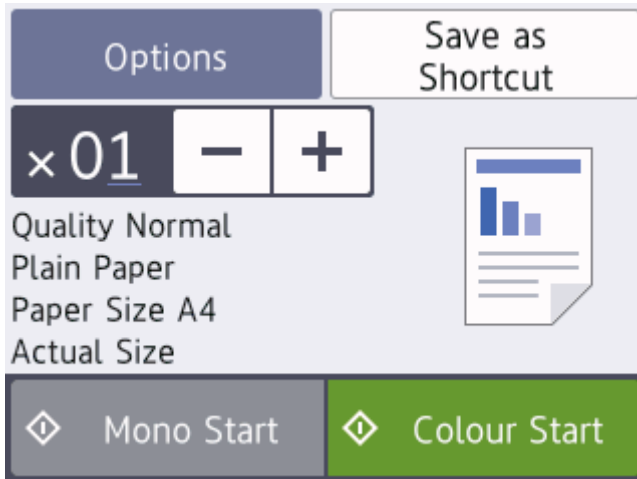

The touchscreen displays:



4. Change the copy settings, if needed.



When you load paper other than A4 size plain paper, you must change the [Paper Size] and [Paper Type] settings by pressing [Options].

Option	Description
 (No. of Copies)	Enter the number of copies in one of the following ways: <ul style="list-style-type: none"><li>• Press – or + on the touchscreen.</li><li>• Press  to display the keyboard on the touchscreen, and then enter the number of copies using the touchscreen keyboard. Press OK.</li></ul>
Options	Press  to change the copy settings for the next copy only. When you have finished changing settings, press OK.
Current setting indications	Press the area indicated on the screen in the previous step to change these settings for the next copy only. <ul style="list-style-type: none"><li>• Quality</li><li>• Paper Type</li><li>• Paper Size</li><li>• Enlarge/Reduce</li></ul> When you have finished changing settings, press OK.



After you have finished selecting new options, you can save them by pressing the [Save as Shortcut] button.

5. Press [Mono Start] or [Colour Start].



To stop copying, press .



---

## Related Information

---

- [Copy](#)



### **Related Topics:**

- [Load Documents in the Automatic Document Feeder \(ADF\)](#)
  - [Load Documents on the Scanner Glass](#)
  - [Copy Options](#)
-

## Enlarge or Reduce Copied Images

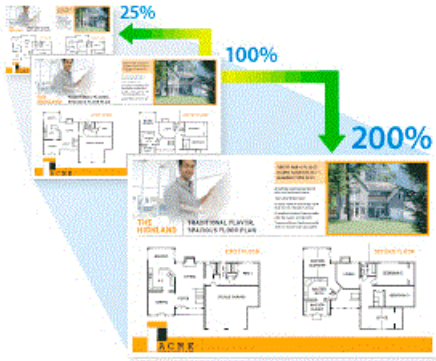
Select an enlargement or reduction ratio to resize your copied data.



1. Load your document.
2. Press  [Copy].
3. Enter the number of copies in one of the following ways:
  - Press [-] or [+] on the touchscreen.
  - Press  **x01** to display the keyboard on the touchscreen, and then enter the number of copies using the touchscreen keyboard. Press [OK].
4. Press [Options] > [Enlarge/Reduce].
5. Press ▲ or ▼ to display the available options, and then press the option you want to change.
6. Do one of the following:
  - If you selected the [Enlarge] or [Reduce] option, press the enlargement or reduction ratio you want to use.
  - If you selected the [Custom (25-400%)] option, press  (backspace) to erase the displayed percentage, or press ◀ to move the cursor, and then enter an enlargement or reduction ratio from [25%] to [400%].  
Press [OK].
  - If you selected [100%] or the [Fit to Page] option, go to the next step.
7. Read and confirm the displayed list of options you have selected, and then press [OK].
8. When you have finished changing settings, press [Mono Start] or [Colour Start].



If you selected the [Fit to Page] option, your machine adjusts the copy size to fit the paper size set in the machine.

- The [Fit to Page] option does not work correctly when the document on the scanner glass is skewed more than three degrees. Using the document guidelines on the left and top, place your document in the upper-left corner, with the document face down on the scanner glass.
- The [Fit to Page] option is not available when using the ADF.
- The [Fit to Page] option is not available for Legal size documents.





### Related Information

- [Copy](#)



## Sort Copies

Sort multiple copies. Pages will be stacked in the order they are fed, that is: 1, 2, 3, and so on.

1. Load your document.
2. Press  [Copy].
3. Enter the number of copies in one of the following ways:
  - Press [-] or [+] on the touchscreen.
  - Press  to display the keyboard on the touchscreen, and then enter the number of copies using the touchscreen keyboard. Press [OK].
4. Press [Options] > [Stack/Sort] > [Sort].
5. Read and confirm the displayed list of settings you have selected, and then press [OK].
6. When you have finished changing settings, press [Mono Start] or [Colour Start]. If you placed the document in the ADF, the machine scans the document and starts printing.
7. If you are using the scanner glass, repeat the following steps for each page of the document:
  - Place the next page on the scanner glass, and then press [Continue] to scan the page.
  - After scanning all the pages, press [Finish].



### Related Information



- [Copy](#)



## Make Page Layout Copies ( N in 1 or Poster)

The N in 1 copy feature saves paper by copying two or four pages of your document onto one page of the copy. The poster feature divides your document into sections, then enlarges the sections so you can assemble them into a poster. To print a poster, use the scanner glass.

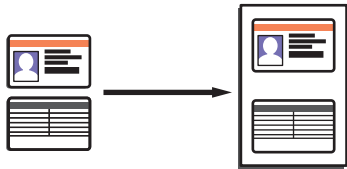

- Make sure the paper size is set to A4, or Letter.
  - You can make only one Poster copy at a time.
1. Load your document.
  2. Press  [Copy].
  3. Enter the number of copies in one of the following ways:
    - Press [-] or [+] on the touchscreen.
    - Press **x01** to display the keyboard on the touchscreen, and then enter the number of copies using the touchscreen keyboard. Press [OK].
  4. Press [Options] > [Page Layout].
  5. Press ▲ or ▼ to display the options, and then press the option you want.

Option	Description
Off (1in1)	-
2in1 (Portrait)	
2in1 (Landscape)	

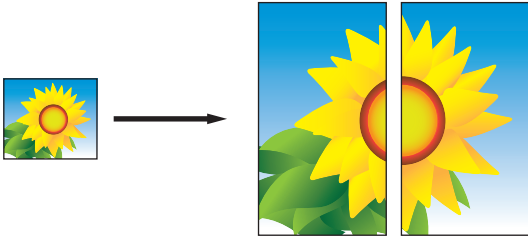
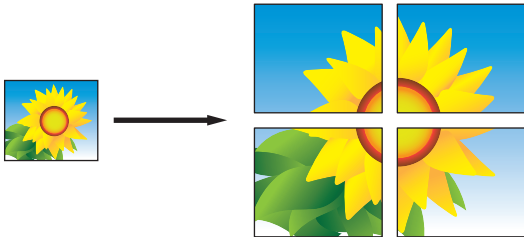
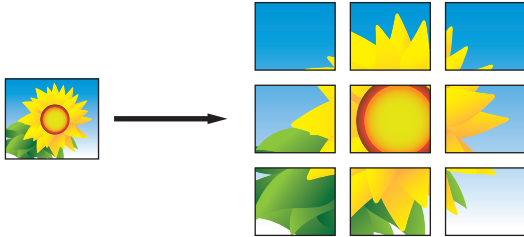
Option	Description
2in1 (ID) (Using the scanner glass)	
4in1 (Portrait)	
4in1 (Landscape)	
Poster (2x1) (Using the scanner glass)	
Poster (2x2) (Using the scanner glass)	
Poster (3x3) (Using the scanner glass)	

6. Read and confirm the displayed list of settings you have selected, and then press [OK].
7. When you have finished changing settings, press [Mono Start] or [Colour Start]. If you placed the document in the ADF or are making a poster, the machine scans the pages and starts printing.
8. If you are using the scanner glass, repeat the following steps for each page of the document:
  - Place the next page on the scanner glass, and then press [Continue] to scan the page.
  - After scanning all the pages, press [Finish].

### Related Information

- [Copy](#)

## Copy on Both Sides of the Paper (2-sided Copy)

Reduce the amount of paper you use by copying onto both sides of the paper.

- You must choose a 2-sided copy layout from the following options before you can start 2-sided copying.
- The layout of your original document determines which 2-sided copy layout you should choose.
- When you manually make 2 sided copies from a 2-sided document, use the scanner glass.
- You can use only A4, A5, or Letter size plain paper.

### Portrait

#### 1-sided to 2-sided (Long Edge Flip)

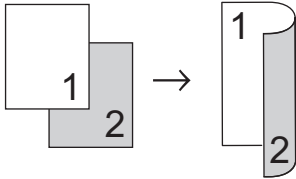

#### 1-sided to 2-sided (Short Edge Flip)

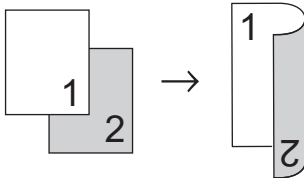

#### 2-sided to 2-sided

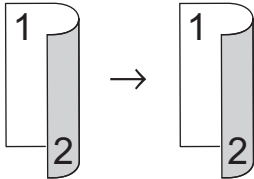

### Landscape

#### 1-sided to 2-sided (Long Edge Flip)

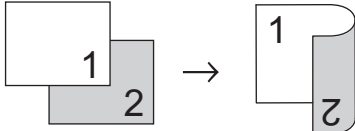

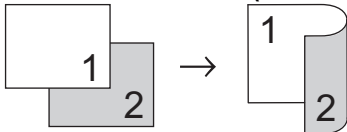

#### 1-sided to 2-sided (Short Edge Flip)

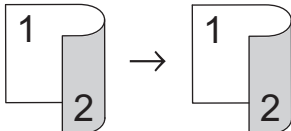

#### 2-sided to 2-sided



1. Load your document.
2. Press  [Copy].
3. Enter the number of copies in one of the following ways:
  - Press [-] or [+] on the touchscreen.
  - Press  to display the keyboard on the touchscreen, and then enter the number of copies using the touchscreen keyboard. Press [OK].

- 
4. To sort multiple copies, press [Options] > [Stack/Sort] > [Sort].
  5. Press ▲ or ▼ to display the [2-sided Copy] option, and then press it.
  6. Do one of the following:
    - To make 2-sided copies from a 1-sided document, follow these steps:
      - a. To change the layout options, press [Layout], and then press [Long Edge Flip] or [Short Edge Flip].
      - b. Press [1-sided⇒2-sided].
    - To make 2-sided copies of a 2-sided document manually, press [2-sided⇒2-sided].



---

Use the scanner glass to make 2-sided copies of a 2-sided document manually.

---

7. Review your settings on the touchscreen, and then press [OK].
8. Press [Mono Start] or [Colour Start]. If you placed the document in the ADF, the machine scans the pages and starts printing.
9. If you are using the scanner glass, repeat the following steps for each page of the document:
  - Place the next page on the scanner glass, and then press [Continue] to scan the page.
  - After scanning all the pages, press [Finish].

DO NOT touch the printed page until it is ejected the second time. The machine will print the first side and eject the paper, and then pull the paper in to print the second side.



---

If you experience smudged printouts or paper jams, press  [Settings] > [Maintenance] > [Print Setting Options] > [Reduce Smudging], and then change settings.

---



## Related Information

- [Copy](#)

### Related Topics:

- [Change the Print Setting Options When Having Printing Problems](#)
-

## Copy an ID Card

Use the [2in1 (ID)] feature to copy both sides of an identification card onto one page, keeping the original card size.

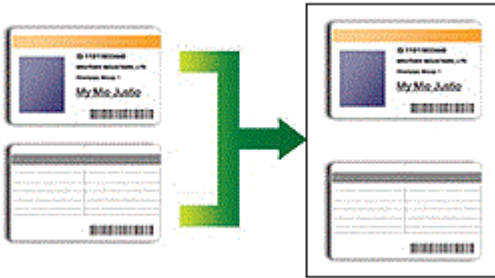

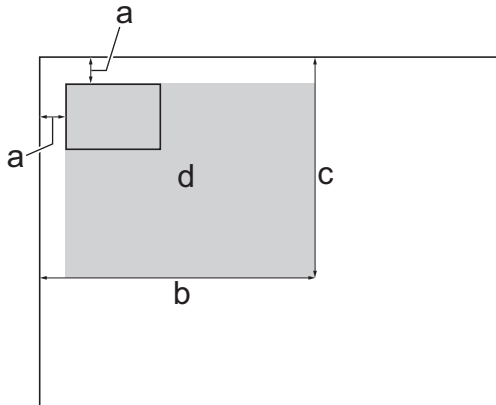

- Make sure the paper size is set to A4 or Letter.
- You may copy an identification card to the extent permitted under applicable laws. For more detailed information, see the *Product Safety Guide*.

1. Place your identification card face down near the upper-left corner of the scanner glass.



- a. 3 mm or greater (top, left)
- b. 207 mm
- c. 145 mm
- d. Scannable area

2. Press  [Copy].
3. Enter the number of copies in one of the following ways:
  - Press [-] or [+] on the touchscreen.
  - Press  to display the keyboard on the touchscreen, and then enter the number of copies using the touchscreen keyboard. Press [OK].
4. Press [Options] > [Page Layout] > [2in1 (ID)].
5. Read and confirm the displayed list of settings you have selected. When you have finished changing settings, press [OK].
6. Press [Mono Start] or [Colour Start].  
The machine starts scanning one side of the identification card.
7. After the machine has scanned the first side, turn over the identification card and press [Continue] to scan the other side.



## Related Information

- [Copy](#)
-



## Copy in Ink Save Mode

When you select Ink Save Mode, the machine prints the colours lighter and emphasises the outlines of the images.



- The amount of ink that is saved varies depending on the type of documents printed.
- Ink Save Mode may make your printouts look different from your original document.
- The Ink Save Mode feature is supported by technology from Reallusion, Inc.



1. Load your document.
2. Press  [Copy].
3. Enter the number of copies in one of the following ways:
  - Press [-] or [+] on the touchscreen.
  - Press  to display the keyboard on the touchscreen, and then enter the number of copies using the touchscreen keyboard. Press [OK].
4. Press [Options] > [Advanced Settings] > [Ink Save Mode].
5. Read and confirm the displayed list of settings you have selected, and then press [OK].
6. When you have finished changing settings, press [Mono Start] or [Colour Start].

### Related Information





- [Copy](#)

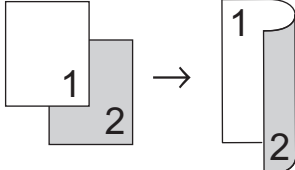
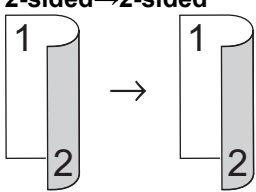
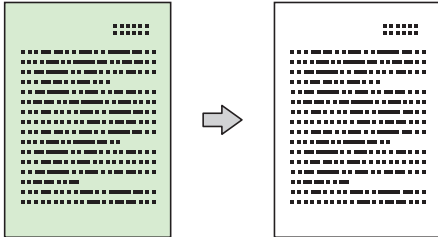
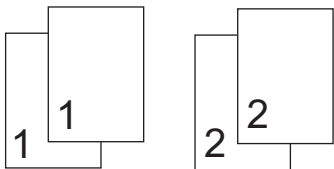
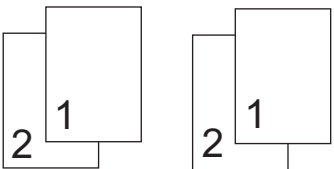

# Copy Options

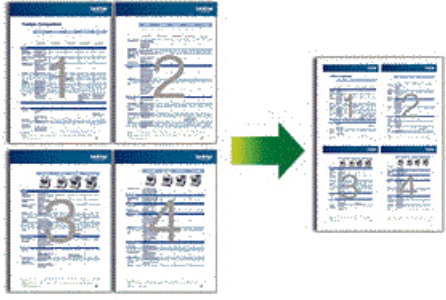
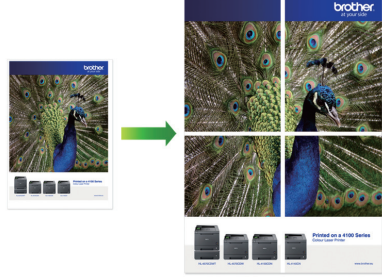
To change copy settings, press the [Options] button.

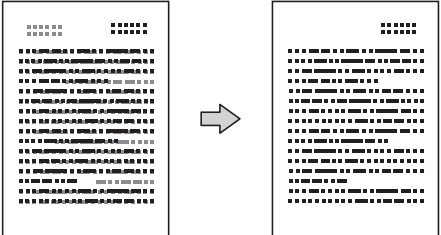
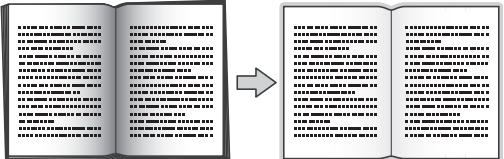
Option	Description	
Quality	Select the Copy resolution for your type of document.	
Paper Type	Select a paper type. If copying on special paper, set the machine for the type of paper you are using to get the best print quality.	
Paper Size	Select a paper size. If copying on paper other than A4 size, you must change the Paper Size setting.	
Enlarge/Reduce	100%	-
	Enlarge	Select an enlargement ratio for the next copy.
	Reduce	Select a reduction ratio for the next copy.
	Fit to Page	Adjusts the copy size to fit on the paper size you have set.
	Custom (25-400%)	Enter an enlargement or reduction ratio.
2-sided Copy	Select to copy on both sides of the paper. <b>1-sided→2-sided</b>  <b>2-sided→2-sided</b> 	
Density	Increase the density to make the text darker. Decrease the density to make the text lighter.	
Remove Background Colour	Removes the document's background colour in copies. The white background becomes more apparent. This saves some ink and may make certain copies easier to read. 	
Stack/Sort	Select to stack or sort multiple copies.	
	<div style="display: flex; justify-content: space-around;"> <div style="text-align: center;"> <p><b>Stack</b></p>  </div> <div style="text-align: center;"> <p><b>Sort</b></p>  </div> </div>	

Option	Description
<p><b>Page Layout</b></p>	<p>Make N in 1, 2 in 1 ID, or Poster copies.</p> <div style="display: flex; justify-content: space-around;"> <div style="text-align: center;"> <p><b>4 in 1</b></p>  </div> <div style="text-align: center;"> <p><b>Poster</b></p>  </div> </div>
<p><b>Advanced Settings</b></p>	<p><b>Ink Save Mode</b> Prints colours lighter and emphasises the outlines of images.</p> 
	<p><b>Thin Paper Copy</b> Avoids bleeding through thin paper when copying.</p> 
	<p><b>Book Copy</b> Corrects dark borders and skew when copying from the scanner glass.</p> 
	<p><b>Watermark Copy</b> Places text in your document as a watermark.</p> 
<p><b>Set New Default</b></p>	<p>Saves the copy settings that you use most often by setting them as the default settings.</p>
<p><b>Factory Reset</b></p>	<p>Restores any changed copy settings to the factory settings.</p>



- You can save the current settings by pressing [Save as Shortcut].
- The Ink Save Mode, Thin Paper Copy, Book Copy and Watermark Copy features are supported by technology from Reallusion, Inc.



## Related Information

- [Copy](#)

### Related Topics:

- [Copy a Document](#)
-

## Fax

- [Send a Fax](#)
- [Receive a Fax](#)
- [Voice Operations and Fax Numbers](#)
- [Telephone Services and External Devices](#)
- [Fax Reports](#)
- [PC-FAX](#)

## Send a Fax

- [Send a Fax from Your Brother Machine](#)
- [Send a Fax Manually](#)
- [Send a Fax at the End of a Conversation](#)
- [Send the Same Fax to More than One Recipient \(Broadcasting\)](#)
- [Send a Fax in Real Time](#)
- [Send a Fax at a Specified Time \(Delayed Fax\)](#)
- [Change the Fax Auto Redial Setting](#)
- [Cancel a Fax in Progress](#)
- [Check and Cancel a Pending Fax](#)
- [Fax Options](#)

## Send a Fax from Your Brother Machine

Related Models: MFC-J1300DW

1. Load your document in the ADF or place it on the scanner glass.
2. Press  [Fax].



If [Fax Preview] is set to [On], press  [Fax] > [Sending Faxes].

The touchscreen displays:

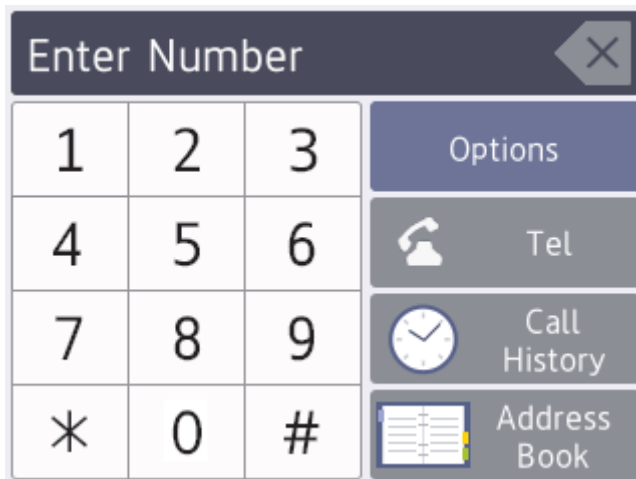

3. Enter the fax number in one of the following ways:
  - Dial Pad (Enter the fax number manually.)  
Press all digits of the number using the touchscreen.
  - Call History  
Press [Call History].  
Press [Redial], [Outgoing Call] or [Caller ID History].  
If you select [Outgoing Call] or [Caller ID History], select the number you want, and then press [Apply].
  - Address Book  
Press [Address Book].  
Do one of the following:
    - Select the number you want, and then press [Apply].
    - Press , and then enter the first letter of the name and press [OK]. Press the name you want to dial. If the name has two numbers, press the number you want. Press [Apply].



If the LDAP search is available, the result will be shown on the touchscreen with .

4. To change the fax settings, press [Options].  
When finished, press [OK].
5. Press [Fax Start].
  - If you are using the ADF, the machine starts scanning and sending the document.
  - If you are using the scanner glass and selected [Mono] in the [Colour Setting], the machine starts scanning the first page.  
Go to the next step.

- 
- If you are using the scanner glass and selected [Colour] in the [Colour Setting], the touchscreen asks if you want to send a colour fax.

Press [Yes (Colour fax)] to confirm. The machine starts dialling and sending the document.

6. When the touchscreen displays [Next page?], do one of the following:

- Press [No] when finished scanning pages. The machine starts sending the document.
- Press [Yes] to scan another page. Place the next page on the scanner glass, and then press [OK]. The machine starts scanning the page.

Repeat this step for each additional page.



## Related Information

- [Send a Fax](#)

### Related Topics:

- [Fax Options](#)
-

## Send a Fax Manually

**Related Models:** MFC-J1300DW

Manual fax transmission lets you hear the dialling, ringing and fax-receiving tones while sending a fax.

1. Load your document.
2. To listen for a dial tone, pick up the handset of the external telephone.
3. Dial the fax number using the external telephone.
4. When you hear fax tones, press  and then press [Fax Start].
  - If you are using the scanner glass, press [Send].
5. Replace the handset of the external phone.

### Related Information

- [Send a Fax](#)



## Send a Fax at the End of a Conversation

**Related Models:** MFC-J1300DW

At the end of a conversation, you can send a fax to the other party before you both hang up.

1. Ask the other party to wait for fax tones (beeps) and to press the Start key before hanging up.
2. Load your document.
3. Press  to display the [Fax Start] button.
4. Press [Fax Start].
  - If you are using the scanner glass, press [Send].
5. Replace the handset of the external telephone.



### Related Information

- [Send a Fax](#)

## Send the Same Fax to More than One Recipient (Broadcasting)

**Related Models:** MFC-J1300DW

Use the Broadcasting feature to send the same fax to multiple fax numbers at the same time.

- This feature is available only for monochrome faxes.
- Address Book numbers must be stored in the machine's memory before they can be used in a broadcast.
- Group numbers must also be stored in the machine's memory before they can be used in a broadcast. Group numbers include many stored Address Book numbers for easier dialling.

You can include Groups, Address Book numbers, and up to 50 manually-dialled numbers in the same broadcast.

If you did not use any of the Address Book numbers for Groups, you can broadcast faxes to as many as 250 different numbers.

1. Load your document.

2. Press  [Fax].



If [Fax Preview] is set to [On], press  [Fax] > [Sending Faxes].

3. Press [Options] > [Broadcasting].

4. Press [Add Number].

You can add numbers to the broadcast in the following ways:

- Press [Add Number] and enter a fax number using the dial pad. Press [OK].
- Press [Add from Address book]. Press ▲ or ▼ to display the numbers you want to add to the broadcast. Select the check boxes of the numbers you want to add.  
When finished, press [OK].
- Press [Search in Address book]. Press the first letter of the name and press [OK]. Press the name, and then press the number you want to add.

Repeat this step to enter additional fax numbers.

5. When finished, press [OK].

6. Press [Fax Start].

7. Do one of the following:

- If you are using the ADF, the machine starts scanning and sending the document.
- If you are using the scanner glass, the machine starts scanning the first page.

When the touchscreen displays [Next page?], do one of the following:

- Press [No] when finished scanning pages. The machine starts sending the document.
- Press [Yes] to scan another page. Place the next page on the scanner glass, and then press [OK]. The machine starts scanning the page.

Repeat this step for each additional page.



### Related Information

- [Send a Fax](#)
  - [Cancel a Broadcast in Progress](#)

### Related Topics:



- [Set up Groups for Broadcasting](#)

- 
- Enter Text on Your Brother Machine
-

## Cancel a Broadcast in Progress

**Related Models:** MFC-J1300DW

While broadcasting you can cancel the fax currently being sent or the whole broadcast job.

1. Press  to return to the Home screen.
2. Press .
3. Do one of the following:
  - To cancel the entire broadcast, press [Entire Broadcast]. Press [Yes] to confirm or press [No] to exit without cancelling.
  - To cancel the current number being dialled, press the name or number on the touchscreen. Press [Yes] to confirm or press [No] to exit without cancelling.
  - To exit without cancelling, press .



### Related Information

- [Send the Same Fax to More than One Recipient \(Broadcasting\)](#)

## Send a Fax in Real Time

**Related Models:** MFC-J1300DW

When sending a fax, the machine scans the document into the memory before sending it. As soon as the telephone line is free, the machine starts dialling and sending. If you want to send an important document immediately without waiting for the machine to retrieve the scan from its memory, turn on [Real Time TX].

- If you are sending a colour fax or if the machine's memory is full and you are sending a monochrome fax from the ADF, the machine sends the document in real time (even if [Real Time TX] is set to [Off]).
- In Real Time Transmission, the automatic redial feature does not work when using the scanner glass.

1. Load your document.

2. Press  [Fax].



If [Fax Preview] is set to [On], press  [Fax] > [Sending Faxes].

3. Press [Options] > [Real Time TX].

4. Press [On] (or [Off]).

5. Press [OK].

6. Enter the fax number.

7. Press [Fax Start].



### Related Information

- [Send a Fax](#)

## Send a Fax at a Specified Time (Delayed Fax)

Related Models: MFC-J1300DW

You can store up to 50 faxes in the machine's memory to be sent within the next twenty-four hour period.

This feature is available only for monochrome faxes.

1. Load your document.

2. Press  [Fax].



If [Fax Preview] is set to [On], press  [Fax] > [Sending Faxes].

3. Press [Options] > [Delayed Fax].

4. Press [Delayed Fax].

5. Press [On].

6. Press [Set Time].

7. Enter the time you want the fax to be sent using the touchscreen. Press [OK].



The number of pages you can scan into the memory depends on the amount and type of data.

8. Press [OK].

9. Enter the fax number.

10. Press [Fax Start].

- If you are using the scanner glass, go to the next step.

11. When the touchscreen displays [Next page?], do one of the following:

- Press [No] when finished scanning pages.
- Press [Yes] to scan another page. Place the next page on the scanner glass, and then press [OK]. The machine starts scanning the page.

Repeat this step for each additional page.



### Related Information



- [Send a Fax](#)

## Change the Fax Auto Redial Setting

**Related Models:** MFC-J1300DW

If you are sending a fax automatically and the line is busy when the Fax Auto Redial setting is set to [On], the machine redials up to three times at five minute intervals.

The default setting is [On].



1. Press  [Settings] > [All Settings] > [Initial Setup] > [Fax Auto Redial].
2. Press [On] or [Off].
3. Press .

### Related Information

- [Send a Fax](#)

## Cancel a Fax in Progress

Related Models: MFC-J1300DW

1. Press  to return to the Home screen.
2. Press  to cancel a fax that is already in progress.
3. When you press  while the machine is dialling or sending, the touchscreen displays [Cancel Job?]. Press [Yes].



### Related Information

- [Send a Fax](#)

#### Related Topics:



- [Telephone and Fax Problems](#)



## Check and Cancel a Pending Fax

**Related Models:** MFC-J1300DW

Follow these steps to view or to cancel faxes stored in the machine's memory and waiting to be sent. If there are no fax jobs in memory, the LCD displays [No Jobs Waiting]. You can cancel a fax job before it is sent.

1. Press  [Settings] > [All Settings] > [Fax] > [Remaining Jobs].
2. Do the following for each fax job you want to check or cancel:
  - a. Press ▲ or ▼ to scroll through the waiting jobs. If needed, press the job you want to cancel.
  - b. Press [OK].
  - c. Press [Yes] to confirm or press [No] to exit without cancelling.
3. When finished, press .



### Related Information

- [Send a Fax](#)

#### Related Topics:

- [Telephone and Fax Problems](#)

## Fax Options

**Related Models:** MFC-J1300DW

To change fax-sending settings, press the [Options] button.

Option	Description
Fax Resolution	Set the resolution for outgoing faxes. The fax quality often can be improved by changing the Fax Resolution.
Contrast	Adjust the contrast. If your document is very light or very dark, changing the contrast may improve the fax quality.
Glass Scan Size	Adjust the scan area of the scanner glass to the size of the document. <i>See Related Information: Scanner Specifications in Specifications.</i>
Broadcasting (monochrome only)	Send the same fax message to more than one fax number at the same time.
Preview (monochrome only)	Preview a fax message before you send it. You cannot send a colour fax when Preview is set to On.
Colour Setting	Set whether faxes are sent in monochrome or colour. <ul style="list-style-type: none"> <li>• Colour faxes cannot be stored in the machine's memory and the machine sends them immediately.</li> <li>• Use the ADF to send colour faxes with multiple pages.</li> <li>• You cannot send a colour fax when Preview is set to On.</li> </ul>
Delayed Fax (monochrome only)	Set the time of day the delayed faxes will be sent.
Batch TX (monochrome only)	Economise by sending all delayed faxes scheduled for the same time and fax number as one fax to save transmission time.
Real Time TX	Send a fax immediately without waiting for the machine to retrieve the scan from its memory.
Overseas Mode	Set to On if you have difficulty sending faxes overseas.
Call History	Select a number from the Call History.
Address Book	Select a number from the Address Book.
Set New Default	Save your settings as the default.
Factory Reset	Restore all settings back to the factory settings.



You can save the current settings by pressing [Save as Shortcut].

You will be asked if you want to make this a One Touch Shortcut. Follow the LCD instructions.



### Related Information

- [Send a Fax](#)

#### Related Topics:

- [Send a Fax from Your Brother Machine](#)
- [Specifications](#)

## Receive a Fax

- [Receive Mode Settings](#)
- [Set Fax Detect](#)
- [Fax Preview](#)
- [Shrink Page Size of an Oversized Incoming Fax](#)
- [Set the Fax Receive Stamp](#)
- [Receive a Fax at the End of a Telephone Conversation](#)
- [Memory Receive Options](#)
- [Remote Fax Retrieval](#)

## Receive Mode Settings

- [Receive Modes Overview](#)
- [Choose the Correct Receive Mode](#)
- [Set the Number of Rings Before the Machine Answers \(Ring Delay\)](#)
- [Set the F/T Ring Time \(Pseudo/Double-ring\)](#)

## Receive Modes Overview

**Related Models:** MFC-J1300DW

Some receive modes answer automatically ([Fax Only] and [Fax/Tel]). You may want to change the Ring Delay before using these modes.

### Fax Only

[Fax Only] mode automatically answers every call as a fax.

### Fax/Tel

[Fax/Tel] mode helps you manage incoming calls, by recognising whether they are fax or voice calls and handling them in one of the following ways:

- Faxes will be received automatically.
- Voice calls will start the F/T ring to tell you to pick up the line. The F/T ring is a pseudo/double-ring made by your machine.

### Manual

[Manual] mode turns off all automatic answering functions (unless you are using the BT Call Sign feature).

To receive a fax in [Manual] mode, lift the handset of the external telephone. When you hear fax tones (short repeating beeps), press the Start button, and then select [Receive] to receive a fax. You can also use the Fax Detect feature to receive faxes by lifting a handset on the same line as the machine.

### External TAD

[External TAD] mode lets an external answering device manage your incoming calls.

Incoming calls will be handled in the following ways:

- Faxes will be received automatically.
- Voice callers can record a message on the external TAD.



### Related Information

- [Receive Mode Settings](#)

#### Related Topics:

- [Set the Number of Rings Before the Machine Answers \(Ring Delay\)](#)
- [Set the F/T Ring Time \(Pseudo/Double-ring\)](#)
- [Set Fax Detect](#)
- [Connect an External TAD](#)

## Choose the Correct Receive Mode

**Related Models:** MFC-J1300DW

You must choose a Receive Mode depending on the external devices and telephone services you have on your line.

By default, your machine automatically will receive any faxes that are sent to it. The diagram below will help you select the correct mode.

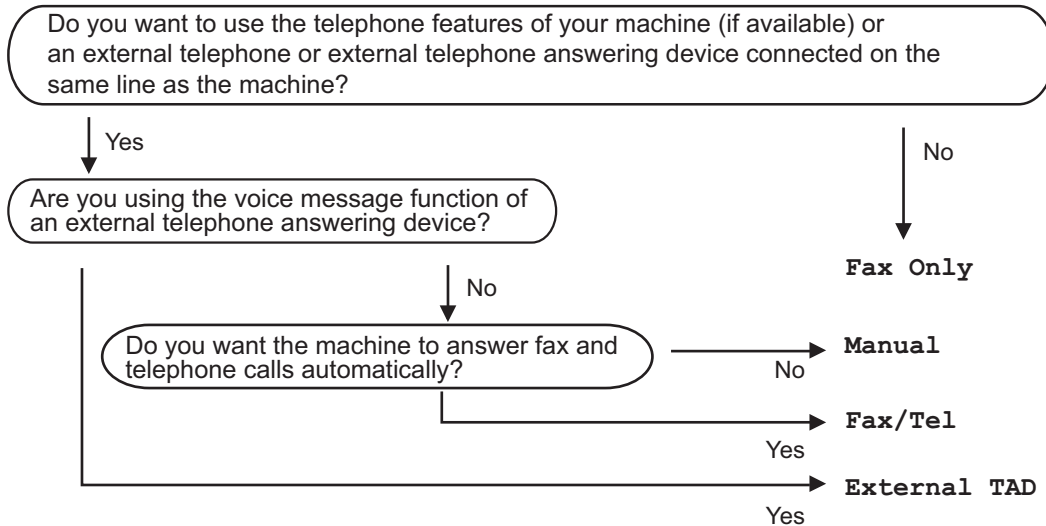

1. Press  [Settings] > [All Settings] > [Fax] > [Setup Receive] > [Receive Mode].



If the option to change the Receive Mode is unavailable, make sure the BT Call Sign feature is set to [Off].

2. Press ▲ or ▼ to display the [Fax Only], [Fax/Tel], [External TAD], or [Manual] option, and then press the option you want.
3. Press .

### Related Information

- [Receive Mode Settings](#)

#### Related Topics:

- [Remote Retrieval Commands](#)
- [Enable the Machine to Work with BT Call Sign \(with Your External Telephone only\)](#)
- [Connect an External TAD](#)
- [Telephone and Fax Problems](#)

## Set the Number of Rings Before the Machine Answers (Ring Delay)

**Related Models:** MFC-J1300DW

When somebody calls your machine, you will hear the normal telephone ring sound. The number of rings is set in the Ring Delay option.

- The Ring Delay setting sets the number of times the machine rings before it answers in [Fax Only] and [Fax/Tel] modes.
- If you have external or extension telephones on the same line as the machine, select the maximum number of rings.

1. Press  [Settings] > [All Settings] > [Fax] > [Setup Receive] > [Ring Delay].
2. Press the number of times you want the line to ring before the machine answers.



If you select [0], the machine will answer immediately and the line will not ring at all (available only for some countries).

3. Press .



### Related Information

- [Receive Mode Settings](#)

#### Related Topics:



- [Receive Modes Overview](#)
- [Operation from External and Extension Telephones](#)
- [Set Fax Detect](#)
- [Telephone and Fax Problems](#)

## Set the F/T Ring Time (Pseudo/Double-ring)

**Related Models:** MFC-J1300DW

When you set the Receive Mode to [Fax/Tel], if the call is a fax, your machine will receive it automatically. However, if it is a voice call, the machine will sound the F/T ring (pseudo/double-ring) for the time you set in the F/T Ring Time option. When you hear the F/T ring, it means that a voice caller is on the line.

Because the F/T ring is a setting only on your Brother machine, extension and external telephones will not ring; however, you can still answer the machine's call on any telephone.

1. Press  [Settings] > [All Settings] > [Fax] > [Setup Receive] > [F/T Ring Time].
2. Press how long the machine will double-ring to alert you to a voice call.
3. Press .



Even if the caller hangs up during the pseudo/double-ringing, the machine will continue to ring for the set time.

### Related Information

- [Receive Mode Settings](#)

#### Related Topics:

- [Receive Modes Overview](#)
- [Operation from External and Extension Telephones](#)



## Set Fax Detect



**Related Models:** MFC-J1300DW

**If Fax Detect is On:** The machine receives a fax call automatically, even if you answer the call. When the message that your machine is receiving a fax appears on the LCD or when you hear “chirps” through the handset you are using, just replace the handset. Your machine will do the rest.

**If Fax Detect is Off:** If you are at the machine and answer a fax call by lifting the handset, press the Start button, and then select [Receive] to receive the fax. If you answered at an extension or external telephone, press \*51.



- If Fax Detect is set to [On], but your machine does not connect a fax call when you lift an extension or external telephone handset, press the remote activation code \*51.
- If you send faxes from a computer on the same telephone line and the machine intercepts them, set Fax Detect to [Off].

1. Press  [Settings] > [All Settings] > [Fax] > [Setup Receive] > [Fax Detect].
2. Press [On] (or [Off]).
3. Press .



### Related Information

- [Receive a Fax](#)

#### Related Topics:

- [Receive Modes Overview](#)
- [Set the Number of Rings Before the Machine Answers \(Ring Delay\)](#)
- [Operation from External and Extension Telephones](#)
- [Use the Remote Codes](#)
- [Telephone and Fax Problems](#)

## Fax Preview

**Related Models:** MFC-J1300DW

Use the Fax Preview feature to view received faxes on the LCD.

- [Set Fax Preview to On](#)
- [Preview New Faxes](#)

## Set Fax Preview to On

Related Models: MFC-J1300DW

- This feature is available only for monochrome faxes.
- When Fax Preview is turned on, a backup copy of received faxes will not be printed for Fax Forwarding, PC-Fax Receiving and Forward to Cloud operations, even if you set Backup Print to On.
- Although printed faxes show the received date and time when Fax Receive Stamp is turned on, the Fax Preview screen will not display the received date and time.

1. Press  [Settings].

2. Press  [Fax Preview].

3. Press [On] (or [Off]).

The touchscreen displays a message saying future received faxes will not be printed.

4. Press [Yes].

5. Press .



If faxes are stored in the memory when you change Fax Preview to Off, do one of the following:

- If you do not want to print the stored faxes, press [Continue].  
Press [Yes] to confirm.  
Your faxes will be deleted.
- To print all the stored faxes, press [Print All Faxes Before Delete].
- If you do not want to turn off Fax Preview, press [Cancel].





### Related Information

- [Fax Preview](#)

## Preview New Faxes

**Related Models:** MFC-J1300DW

When a fax is received, a message appears on the LCD.

- This feature is available only for monochrome faxes.
- To see a fax you already previewed, press  [Fax] and  [Received Faxes].

1. Press  to view new faxes.

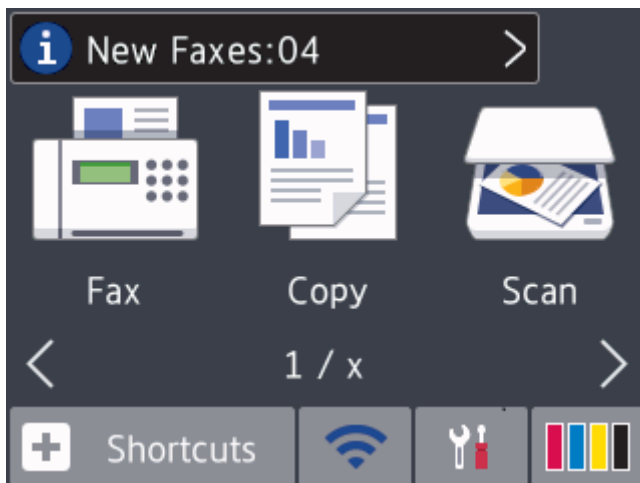

2. The fax list includes old and new faxes. A blue mark appears next to new faxes.  
Press the fax you want.

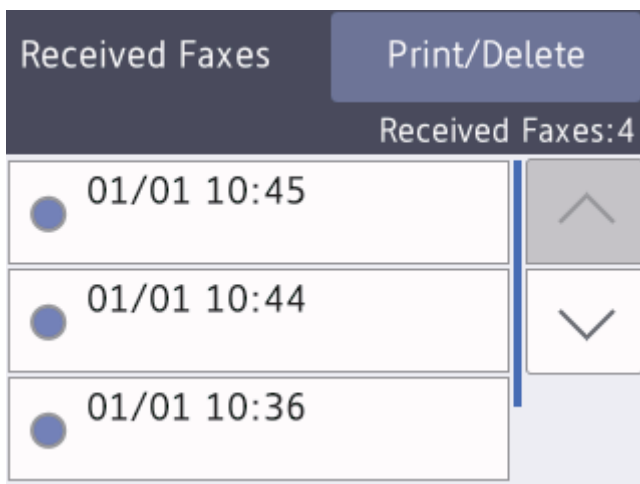











 If you want to print or delete all the faxes in the list, press [Print/Delete].

Do one of the following:

- Press [Print All (New Faxes)] to print all faxes you have not yet viewed.
- Press [Print All (Old Faxes)] to print all faxes you have viewed.
- Press [Delete All (New Faxes)] to delete all faxes you have not yet viewed.
- Press [Delete All (Old Faxes)] to delete all faxes you have viewed.

3. Perform the following operations by pressing the buttons shown in the table:

Button	Result
	Enlarge the fax.
	Reduce the fax.
 or 	Scroll vertically.
 or 	Scroll horizontally.
	Rotate the fax clockwise.
	Delete the fax. Press <b>Yes</b> to confirm.
	Go back to the previous page.
	Go to the next page.
	Go back to the fax list.

Start

Print the fax.

If the fax is a single page, it starts printing. A touchscreen message asks if you want to delete the fax from the machine's memory. To delete the fax, press **Yes**. To keep the fax in the machine's memory, press **No**.

If the fax has multiple pages, do one of the following:

- Press **Print All Pages** to print the whole message. A touchscreen message asks if you want to delete the fax from the machine's memory. To delete the fax, press **Yes**. To keep the fax in the machine's memory, press **No**.
- Press **Print Displayed Only** to print only the displayed page.
- Press **Print From Displayed** to print from the displayed page to the last page.

- If your fax is large there may be a delay before it is displayed.
- The touchscreen displays the current page number and total pages of the fax message.

4. Press .



## Related Information

- [Fax Preview](#)

## Shrink Page Size of an Oversized Incoming Fax

**Related Models:** MFC-J1300DW

When the [Auto Reduction] feature is [On], your Brother machine reduces any oversized incoming fax page to fit on your paper. The machine calculates the reduction ratio using the page size of the fax, and your Paper Size setting.

1. Press  [Settings] > [All Settings] > [Fax] > [Setup Receive] > [Auto Reduction].
2. Press [On] (or [Off]).
3. Press .

### Related Information

- [Receive a Fax](#)

#### **Related Topics:**



- [Paper Settings](#)
- [Paper Handling and Printing Problems](#)

## Set the Fax Receive Stamp

**Related Models:** MFC-J1300DW

Set the machine to print the date and time of receipt at the top of each incoming fax page. Make sure you have set the current date and time on the machine.

This feature is available only for monochrome faxes.

1. Press  [Settings] > [All Settings] > [Fax] > [Setup Receive] > [Fax Rx Stamp].
2. Press [On] (or [Off]).
3. Press .

### Related Information

- [Receive a Fax](#)

## Receive a Fax at the End of a Telephone Conversation

**Related Models:** MFC-J1300DW

If you are speaking on the telephone connected to your Brother machine and the other party is also speaking on a telephone connected to his fax machine, at the end of the conversation, the other party can send you a fax before you both hang up.

- Your machine's ADF must be empty.

  1. Ask the other party to load the fax and to press the Start or Send key.
  2. Press  to display the [Fax Start] button.
  3. When you hear CNG tones (slow, repeated beeps), press [Fax Start].
  4. Press [Receive] to receive the fax.
  5. Replace the external handset.



### Related Information

- [Receive a Fax](#)



## Memory Receive Options

**Related Models:** MFC-J1300DW

Use Memory Receive options to direct incoming faxes while you are away from the machine. You can use only one Memory Receive option at a time.

Memory Receive can be set to:

- Fax Forwarding
- Fax Storage
- PC-Fax Receive
- Forward to Cloud

The machine forwards your received faxes to the online services.

- Off

This feature is available only for monochrome faxes.

- [Forward Incoming Faxes to Another Machine](#)
- [Store Incoming Faxes in the Machine's Memory](#)
- [Use PC-Fax Receive to Transfer Received Faxes to Your Computer \(Windows only\)](#)
- [Change Memory Receive Options](#)
- [Turn Off Memory Receive](#)
- [Print a Fax Stored in the Machine's Memory](#)
- [Turn On FaxForward to Cloud or E-mail](#)

## Forward Incoming Faxes to Another Machine

Related Models: MFC-J1300DW

Use the Fax Forwarding feature to automatically forward your incoming faxes to another machine.

This feature is available only for monochrome faxes.

1. Press  [Settings] > [All Settings] > [Fax] > [Setup Receive] > [Memory Receive].
2. Press ▲ or ▼ to display the [Fax Forward] option, and then press it.
3. Enter the forwarding fax number (up to 20 digits) using the dial pad.  
Press [OK].
4. Press [Backup Print: On] or [Backup Print: Off].



- If you select [Backup Print: On], the machine prints received faxes at your machine so you will have a copy.
- When Fax Preview is turned on, a backup copy of received faxes will not be printed.
- If you receive a colour fax, your machine only prints the colour fax and does not forward it to the Fax Forwarding number you programmed.

5. Press .



### Related Information





- [Memory Receive Options](#)

## Store Incoming Faxes in the Machine's Memory

**Related Models:** MFC-J1300DW

Use the Fax Storage feature to store incoming faxes in the machine's memory. Retrieve your stored fax messages from your fax machine when you are at another location using the Remote Retrieval commands. Your machine prints a backup copy of each stored fax.

- This feature is available only for monochrome faxes.

1. Press  [Settings] > [All Settings] > [Fax] > [Setup Receive] > [Memory Receive].
2. Press  or  to display the [Fax Storage] option, and then press it.
3. Press .

### Related Information

- [Memory Receive Options](#)

#### **Related Topics:**

- [Forward Faxes Remotely](#)
- [Print a Fax Stored in the Machine's Memory](#)
- [Remote Retrieval Commands](#)

## Use PC-Fax Receive to Transfer Received Faxes to Your Computer (Windows only)

**Related Models:** MFC-J1300DW

Turn on the PC-Fax Receive feature, automatically store incoming faxes to your machine's memory, and then send them to your computer. Use your computer to view and store these faxes.

- This feature is available only for monochrome faxes. When you receive a colour fax, your machine prints the colour fax but does not send the fax to your computer.
- Before you can set up PC-Fax Receive, you must install the Brother software and drivers on your computer. Make sure your computer is connected and turned on. You must have the PC-FAX Receiving software running on your computer.

Even if your computer is turned off, your machine will receive and store faxes in its memory. When you start your computer and the PC-FAX Receiving software runs, your machine transfers faxes to your computer automatically.

1. Press  [Settings] > [All Settings] > [Fax] > [Setup Receive] > [PC Fax Receive].
2. Press [On].  
The touchscreen displays the message [Run the PC-Fax Receive program on your computer.]
3. Press [OK].
4. Press [<USB>] or press the name of the destination computer you want to receive faxes if you are on a network. Press [OK].
5. Press [Backup Print: On] or [Backup Print: Off].



When Fax Preview is turned on, a backup copy of received faxes will not be printed.

6. Press .

To change the destination computer, repeat these steps.



### Related Information

- [Memory Receive Options](#)

#### Related Topics:

- [Transfer Your Faxes or Fax Journal Report](#)
- [Transfer Faxes to Your Computer](#)
- [Receive Faxes Using PC-FAX Receive \(Windows\)](#)

## Change Memory Receive Options

Related Models: MFC-J1300DW

If there are faxes in your machine's memory when you change any Memory Receive option, the LCD displays one of the following questions:

- **If received faxes have already been printed, the touchscreen displays [Erase all documents?]**
  - If you press [Yes], faxes in the memory will be erased before the setting changes.
  - If you press [No], faxes in the memory will not be erased and the setting will be unchanged.
- **If unprinted faxes are in the machine's memory, the touchscreen displays [Print all faxes?]**
  - If you press [Yes], faxes in the memory will be printed before the setting changes.
  - If you press [No], faxes in the memory will not be printed and the setting will be unchanged.
- If received faxes are left in the machine's memory when you change to [PC Fax Receive] from another option ([Fax Forward], [Forward to Cloud], or [Fax Storage]), press [<USB>] or the name of the computer if you are on a network, and then press [OK]. You will be asked if you want to turn on Backup Print.

The touchscreen displays:

[Send Fax to PC?]

- If you press [Yes], faxes in the memory will be sent to your computer before the setting changes.
- If you press [No], faxes in the memory will not be erased and the setting will be unchanged.

### ✓ Related Information

- [Memory Receive Options](#)

#### Related Topics:

- [Turn Off Memory Receive](#)

## Turn Off Memory Receive

**Related Models:** MFC-J1300DW

Turn off Memory Receive if you do not want the machine to save or transfer incoming faxes.

1. Press  [Settings] > [All Settings] > [Fax] > [Setup Receive] > [Memory Receive].
2. Press [Off].



The touchscreen displays [Print all faxes?] or [Erase all documents?] if received faxes are in your machine's memory.

3. Press .



### Related Information

- [Memory Receive Options](#)

#### Related Topics:

- [Change Memory Receive Options](#)
- [Error and Maintenance Messages](#)
- [Telephone and Fax Problems](#)

## Print a Fax Stored in the Machine's Memory

Related Models: MFC-J1300DW

- This feature is available only for monochrome faxes.
- After you print the fax, it is erased from the machine's memory.

If you select [Fax Storage], you can print all faxes from the memory.

1. Press  [Settings] > [All Settings] > [Fax] > [Print Document].



You can also print the faxes from the memory by pressing [Stored Faxes] on the touchscreen.

2. Press [Yes].



### Related Information

- [Memory Receive Options](#)

#### Related Topics:

- [Store Incoming Faxes in the Machine's Memory](#)
- [Error and Maintenance Messages](#)
- [Telephone and Fax Problems](#)

## Remote Fax Retrieval

**Related Models:** MFC-J1300DW

Use Remote Retrieval to call your machine from any touch-tone telephone or fax machine, and use a remote access code and remote commands to retrieve fax messages.

- [Set a Remote Access Code](#)
- [Use Your Remote Access Code](#)
- [Remote Retrieval Commands](#)
- [Forward Faxes Remotely](#)
- [Change the Fax Forwarding Number](#)



## Set a Remote Access Code

Related Models: MFC-J1300DW

Set a Remote Access Code to access and control your Brother machine even when you are away from it.

1. Press  [Settings] > [All Settings] > [Fax] > [Remote Access].
2. Enter a three-digit code using the numbers [0] through [9], [\*], or [#] using the dial pad (The preset '\*' cannot be changed).

Press [OK].



- DO NOT use the same code used for your Remote Activation Code (\*51) or Remote Deactivation Code (#51).
- To delete your code, press and hold  to restore the inactive setting (- - \*), and then press [OK].

3. Press .



### Related Information

- [Remote Fax Retrieval](#)

#### Related Topics:

- [Use Your Remote Access Code](#)
- [Operation from External and Extension Telephones](#)
- [Use the Remote Codes](#)

## Use Your Remote Access Code

**Related Models:** MFC-J1300DW

1. When away from your Brother machine, dial your fax number from a touch-tone telephone or fax machine.
2. When your machine answers, immediately enter your three-digit Remote Access Code, followed by \*.
3. Your Brother machine signals if it has received faxes:
  - One long beep - the machine received at least one fax
  - No beeps - the machine has not received a fax
4. When the machine gives two short beeps, enter a command.
  - The machine will hang up if you wait longer than 30 seconds to enter a command.
  - The machine will beep three times if you enter an invalid command.
5. When finished, press 9, and then press 0 to deactivate your machine.
6. Hang up.



This feature may not be available in some countries or supported by your local telephone company.



### Related Information

- [Remote Fax Retrieval](#)

#### Related Topics:

- [Set a Remote Access Code](#)

## Remote Retrieval Commands

**Related Models:** MFC-J1300DW

Use the Remote Commands in this table to access fax commands and options when you are away from your Brother machine. When you call the machine and enter your remote access code (three digits followed by \*), the system will sound two short beeps and you must enter a Remote Command (column 1), followed by one of the options (column 2) for that command.

Remote commands	Options	Operation details
95	<b>Change the Fax Forwarding, or Fax Storage settings</b>	
	1 OFF	You can select <i>Off</i> after you retrieve or erase all your messages.
	2 Fax Forwarding	One long beep means the change is accepted. If you hear three short beeps, you cannot make a change because something has not been set up (for example, a Fax Forwarding number has not been registered). You can register your Fax Forwarding number by entering 4. After you register the number, Fax Forwarding will work.
	4 Fax Forwarding number	
	6 Fax Storage	
96	<b>Retrieve a fax</b>	
	2 Retrieve all faxes	Enter the fax number of a remote fax machine to receive stored fax messages.
	3 Erase faxes from memory	If you hear one long beep, fax messages have been erased from memory.
97	<b>Check the receiving status</b>	
	1 Fax	Check whether your machine has received any faxes. If yes, you will hear one long beep. If not, you will hear three short beeps.
98	<b>Change the Receive Mode</b>	
	1 External TAD	One long beep means the change has been accepted.
	2 Fax/Tel	
	3 Fax Only	
90	<b>Exit</b>	Press <b>9 0</b> to stop remote retrieval. Wait for the long beep, then hang up.

### Related Information

- [Remote Fax Retrieval](#)

#### Related Topics:

- [Change the Fax Forwarding Number](#)
- [Store Incoming Faxes in the Machine's Memory](#)
- [Forward Faxes Remotely](#)
- [Choose the Correct Receive Mode](#)

## Forward Faxes Remotely

**Related Models:** MFC-J1300DW

Call your Brother machine from any touch-tone telephone or fax machine to forward incoming faxes to another machine.

- You must turn on Fax Storage, or Fax Preview before you use this feature.

1. Dial your fax number.
2. When your machine answers, enter your Remote Access Code (three digits followed by \*). If you hear one long beep, you have messages.
3. When you hear two short beeps, press 9 6 2.
4. Wait for the long beep, and then use the dial pad to enter the fax number (up to 20 digits) of the remote fax machine where you want your fax messages sent, followed by # #.



You cannot use \* and # as dial numbers but you can press # to insert a pause in the fax number.

5. Hang up after you hear one long beep. Your Brother machine will forward any incoming faxes to the fax number you entered. The other fax machine will then print your fax messages.



### Related Information

- [Remote Fax Retrieval](#)

#### Related Topics:

- [Store Incoming Faxes in the Machine's Memory](#)
- [Remote Retrieval Commands](#)

## Change the Fax Forwarding Number

**Related Models:** MFC-J1300DW

1. Dial your fax number.
2. When your machine answers, enter your Remote Access Code (three digits followed by \*). If you hear one long beep, you have messages.
3. When you hear two short beeps, press 9 5 4.
4. Wait for the long beep, enter the new number (up to 20 digits) of the remote fax machine you want your fax messages forwarded to using the dial pad, then enter # #.



You cannot use \* and # as dial numbers but you can press # to insert a pause in the fax number.

5. Press 9 0 to stop Remote Access when finished.
6. Hang up after you hear one long beep.



### Related Information

- [Remote Fax Retrieval](#)

#### Related Topics:

- [Remote Retrieval Commands](#)

## Voice Operations and Fax Numbers

- [Voice Operations](#)
- [Store Fax Numbers](#)
- [Set up Groups for Broadcasting](#)

## Voice Operations

- [Pick up a Voice Call in Fax/Tel Receive Mode](#)

## Pick up a Voice Call in Fax/Tel Receive Mode

**Related Models:** MFC-J1300DW

When the machine is in Fax/Tel mode, it will use the F/T Ring (pseudo/double-ringing) to alert you to pick up a voice call.

If you are at the machine, lift the external telephone's handset, and then press [Pickup] button to answer.

If you are at an extension telephone, lift the handset during the F/T Ring and then press #51 between the pseudo/double rings. If no one is on the line, or if someone wants to send you a fax, send the call back to the machine by pressing \*51.



### Related Information

- [Voice Operations](#)



## Store Fax Numbers

**Related Models:** MFC-J1300DW

- [Store Address Book Numbers](#)
- [Store Address Book Numbers from Outgoing Calls](#)
- [Store Address Book Numbers from Caller ID History](#)
- [Change or Delete Address Book Names or Numbers](#)

## Store Address Book Numbers

Related Models: MFC-J1300DW

1. Press  [Fax] > [Address Book].
2. Do the following steps:
  - a. Press [Edit] > [Add New Address] > [Name].
  - b. Enter the name (up to 16 characters) using the touchscreen. Press [OK].
  - c. Press [Address 1].
  - d. Enter the first fax or telephone number (up to 20 digits) using the touchscreen. Press [OK].

---

  -  Press [Pause] to insert a pause between numbers. You can press [Pause] as many times as needed to increase the length of the pause.
  - Be sure to include the area code when entering a fax or telephone number. Depending on the country, the Caller ID names and history may not be displayed correctly if the area code is not registered with the fax or telephone number.

---

  - e. To store the second fax or telephone number, press [Address 2]. Enter the second fax or telephone number (up to 20 digits) using the touchscreen. Press [OK].
  - f. Press [OK] to confirm.

To store another Address Book number, repeat these steps.
3. Press .

### Related Information

- [Store Fax Numbers](#)

#### Related Topics:

- [Set up Groups for Broadcasting](#)

## Store Address Book Numbers from Outgoing Calls

Related Models: MFC-J1300DW

You can store Address Book numbers from the Outgoing Call history.

1. Press  [Fax] > [Call History] > [Outgoing Call].
2. Press ▲ or ▼ to display the number you want to store, and then press it.
3. Press [Edit] > [Add to Address Book] > [Name].



---

To delete the number from the Outgoing Call history list, press [Edit] > [Delete]. Press [Yes] to confirm.

---

4. Enter the name (up to 16 characters) using the touchscreen. Press [OK].
5. To store the second fax or telephone number, press [Address 2]. Enter the second fax or telephone number (up to 20 digits) using the touchscreen. Press [OK].
6. Press [OK] to confirm the fax or telephone number you want to store.
7. Press .



### Related Information

- [Store Fax Numbers](#)

#### Related Topics:

- [Enter Text on Your Brother Machine](#)

## Store Address Book Numbers from Caller ID History

**Related Models:** MFC-J1300DW

If you have a Caller ID subscriber service from your telephone company, you can store Address Book numbers from incoming calls in the Caller ID history.

1. Press  [Fax] > [Call History] > [Caller ID History].
2. Press ▲ or ▼ to display the name or number you want to store, and then press it.
3. Press [Edit] > [Add to Address Book] > [Name].



To delete the number from the Caller ID history list, press [Edit] > [Delete]. Press [Yes] to confirm.

4. Enter the name (up to 16 characters) using the touchscreen. Press [OK].
5. To store the second fax or telephone number, press [Address 2]. Enter the second fax or telephone number (up to 20 digits) using the touchscreen. Press [OK].
6. Press [OK] to confirm the fax or telephone number you want to store.
7. Press .



### Related Information

- [Store Fax Numbers](#)

#### Related Topics:

- [Caller ID](#)
- [Enter Text on Your Brother Machine](#)

## Change or Delete Address Book Names or Numbers

Related Models: MFC-J1300DW

1. Press  [Fax] > [Address Book] > [Edit].
2. Do one of the following:
  - Press [Change] to edit the names or fax or telephone numbers.  
Press ▲ or ▼ to display the number you want to change, and then press it.
    - To change the name, press [Name]. Enter the new name (up to 16 characters) using the touchscreen. Press [OK].
    - To change the first fax or telephone number, press [Address 1]. Enter the new fax or telephone number (up to 20 digits) using the touchscreen. Press [OK].
    - To change the second fax or telephone number, press [Address 2]. Enter the new fax or telephone number (up to 20 digits) using the touchscreen. Press [OK].

Press [OK] to finish.



To change a character, press ◀ or ▶ to position the cursor to highlight the character you want to change, and then press . Enter the new character.

- To delete numbers, press ▲ or ▼ to display [Delete], and then press it.
    - Select the fax or telephone numbers you want to delete by pressing them to display check marks, and then press [OK].
3. Press .



### Related Information

- [Store Fax Numbers](#)

## Set up Groups for Broadcasting

**Related Models:** MFC-J1300DW

A Group, which can be stored in the Address Book, allows you to send the same fax message to many fax numbers.

First, you must store each fax number in the Address Book. Then you can include them as numbers in the Group. Each Group uses up an Address Book number. You can store up to six Groups, or you can assign up to 198 numbers to a large Group.

1. Press  [Fax] > [Address Book].
2. Do the following steps:
  - a. Press [Edit] > [Setup Groups] > [Name].
  - b. Enter the Group name (up to 16 characters) using the touchscreen. Press [OK].
  - c. Press [Add/Delete].
  - d. Add Address Book numbers to the Group by pressing them to display a checkmark. Press [OK].
  - e. Read and confirm the displayed list of names and numbers you have selected, and then press [OK] to save your Group.

To store another Group for broadcasting, repeat these steps.

3. Press .



### Related Information

- [Voice Operations and Fax Numbers](#)
  - [Change a Broadcasting Group Name](#)
  - [Delete a Broadcasting Group](#)
  - [Add or Delete a Broadcasting Group Member](#)

#### Related Topics:

- [Send the Same Fax to More than One Recipient \(Broadcasting\)](#)
- [Store Address Book Numbers](#)

## Change a Broadcasting Group Name

Related Models: MFC-J1300DW

1. Press  [Fax] > [Address Book] > [Edit] > [Change].
2. Press ▲ or ▼ to display the Group you want to change, and then press it.
3. Press [Name].
4. Enter the new Group name (up to 16 characters) using the touchscreen. Press [OK].



To change a character, press ◀ or ▶ to position the cursor to highlight the incorrect character, and then press .

Enter the new character.

5. Press [OK].
6. Press .



### Related Information



- [Set up Groups for Broadcasting](#)

#### Related Topics:

- [Enter Text on Your Brother Machine](#)

## Delete a Broadcasting Group

Related Models: MFC-J1300DW

1. Press  [Fax] > [Address Book] > [Edit] > [Delete].
2. Press ▲ or ▼ to display the Group you want to delete, and then press it.
3. Press [OK].
4. Press .



### Related Information

- [Set up Groups for Broadcasting](#)



## Add or Delete a Broadcasting Group Member

Related Models: MFC-J1300DW

1. Press  [Fax] > [Address Book] > [Edit] > [Change].
2. Press ▲ or ▼ to display the Group you want to change, and then press it.
3. Press ▲ or ▼ to display [Add/Delete], and then press it.
4. Press ▲ or ▼ to display the number you want to add or delete.
5. Do the following for each number you want to change:
  - To add a number to the Group, press the check box of the number to add a check mark.
  - To delete a number from the Group, press the check box of the number to remove the check mark.
6. Press [OK].
7. Press [OK].
8. Press .



### Related Information

- [Set up Groups for Broadcasting](#)

## Telephone Services and External Devices

- [Use BT Call Sign](#)
- [Caller ID](#)
- [Set the Telephone Line Type](#)
- [Voice Over Internet Protocol \(VoIP/Telephone Line Interference\)](#)
- [External TAD \(Telephone Answering Device\)](#)
- [External and Extension Telephones](#)

## Use BT Call Sign

**Related Models:** MFC-J1300DW

This feature of the machine lets you use the BT Call Sign subscriber service which allows you to have at least two separate telephone numbers on one telephone line. Each telephone number has its own distinctive ringing pattern, so you know which telephone number is ringing. This is one way you can have a separate telephone number for your machine.

Your machine has a BT Call Sign compatible distinctive ringing function, allowing you to dedicate a second telephone number (on the same telephone line) just for receiving faxes.



- This feature is available only in the U.K.
- You can switch BT Call Sign Off temporarily, then turn it back on. When you get a new fax number, make sure you reset this function. This machine will automatically answer incoming calls that use your new fax number.
- When you set the BT Call Sign feature to On, the receive mode is set to [Manual] automatically. [Manual] mode will not respond to incoming telephone calls, since the number you use for telephone calls will use the normal ring pattern.





### Related Information

- [Telephone Services and External Devices](#)
  - [Enable the Machine to Work with BT Call Sign \(with Your External Telephone only\)](#)

## Enable the Machine to Work with BT Call Sign (with Your External Telephone only)

**Related Models:** MFC-J1300DW

This feature is available only in the U.K.

1. Press  [Settings] > [All Settings] > [Fax] > [Miscellaneous] > [BT Call Sign].
2. Press [On] (or [Off]).
3. Press .

When you turn off BT Call Sign, the receive mode stays in [Manual]. You must set the receive mode again.

### Related Information

- [Use BT Call Sign](#)

#### **Related Topics:**

- [Choose the Correct Receive Mode](#)
- [Error and Maintenance Messages](#)

## Caller ID

**Related Models:** MFC-J1300DW

The Caller ID feature lets you use the Caller ID subscriber service offered by many local telephone companies. This service displays the telephone number, or name if it is available, of your caller as the line rings.

- The [ID Unknown] message means the call originated outside your Caller ID service area.
- The [ID Withheld] message means the caller has intentionally blocked transmission of Caller ID information.

Call your telephone company for more information.

Once you answer a call, the Caller ID information disappears from the LCD and is stored in Caller ID memory.

View the list or select a number and fax to it, add it to the Address Book, or delete it from the history.

You can print a list of the Caller ID information received by your machine.



- This feature is not available in some countries.
- The Caller ID service varies with different carriers. Contact your local telephone company to learn about the service available in your area.



### Related Information

- [Telephone Services and External Devices](#)
  - [Set Caller ID to On](#)

#### Related Topics:



- [Store Address Book Numbers from Caller ID History](#)
- [Print a Report](#)
- [Error and Maintenance Messages](#)

## Set Caller ID to On

**Related Models:** MFC-J1300DW

This feature is available only in the U.K. and Ireland.

If you subscribe to the Caller ID service on your phone line, set Caller ID to On to display the caller's telephone number on the LCD as the telephone rings.

1. Press  [Settings] > [All Settings] > [Fax] > [Miscellaneous] > [Caller ID].
2. Press [On].
3. Press .



### Related Information

- [Caller ID](#)

## Set the Telephone Line Type

**Related Models:** MFC-J1300DW

If you are connecting the machine to a line that features PBX or ISDN to send and receive faxes, you must select a Telephone Line Type that matches your line's features.

1. Press  [Settings] > [All Settings] > [Initial Setup] > [Phone Line Set].
2. Press [Normal], [PBX], or [ISDN].
3. Press .

### Related Information

- [Telephone Services and External Devices](#)
  - [PBX and TRANSFER](#)

#### **Related Topics:**

- [Telephone and Fax Problems](#)

## PBX and TRANSFER

**Related Models:** MFC-J1300DW

The machine's [Phone Line Set] default setting is [Normal], which lets the machine connect to a standard Public Switched Telephone Network (PSTN) line. However, many offices use a central telephone system or Private Branch Exchange (PBX). Your machine can be connected to most types of PBX. The machine's recall feature supports timed break recall only (TBR). TBR will work with most PBX systems allowing you to gain access to an outside line, or transfer calls to another extension. Press [R] to use this feature.



Program a press of the [R] button as part of a number stored in the Address Book. When programming the Address Book number, press [R] first (the LCD displays '!'), then enter the telephone number. This avoids having to press [R] each time before you dial from the Address Book. However, your Telephone Line Type must be set to PBX on the machine for you to use this feature.



### Related Information

- [Set the Telephone Line Type](#)



## Voice Over Internet Protocol (VoIP/Telephone Line Interference)

**Related Models:** MFC-J1300DW

VoIP is a type of phone system that uses an Internet connection instead of a traditional telephone line. Telephone providers frequently bundle VoIP together with Internet and cable services.

Your machine may not work with some VoIP systems. If you want to use your machine to send and receive faxes on a VoIP system, make sure one end of your telephone cord is connected to the socket labelled **LINE** on your machine. The other end of the telephone cord may be connected to a modem, phone adapter, splitter, or other such device.

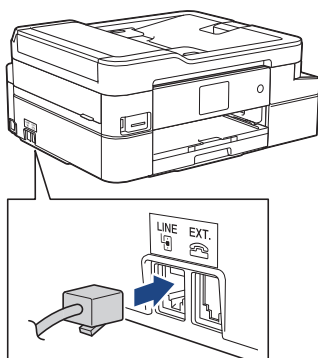

If you have questions about how to connect your machine to the VoIP system, please contact your VoIP provider.

After you have connected your machine to the VoIP system, check for a dial tone. Lift the external telephone's handset and listen for a dial tone. If there is no dial tone, please contact your VoIP provider.

If you are having problems sending or receiving faxes over a VoIP system, we recommend changing the machine's modem speed to the `[Basic (for VoIP)]` setting.



### Related Information

- [Telephone Services and External Devices](#)

#### Related Topics:

- [Telephone Line Interference/VoIP](#)

## External TAD (Telephone Answering Device)

**Related Models:** MFC-J1300DW

You can connect an external Telephone Answering Device (TAD) to the same line as your machine. When the TAD answers a call, your machine will “listen” for the CNG (fax calling) tones sent by a sending fax machine. If it hears them it will take over the call and receive the fax. If it does not hear them, it will let your TAD take a voice message and the LCD will show [Telephone].

The external TAD must answer within four rings (we recommend setting it to two rings). This is because your machine cannot hear the CNG tones until the external TAD has picked up the call. The sending machine will send CNG tones for only eight to ten seconds longer. We do not recommend using the toll saver feature on your external TAD if it needs more than four rings to activate it.

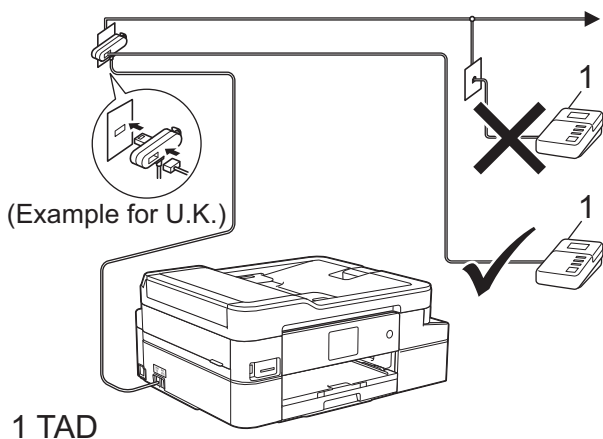

### IMPORTANT

DO NOT connect a TAD elsewhere on the same telephone line.



If you have problems receiving faxes, reduce the Ring Delay setting on your external TAD.

### ✓ Related Information

- [Telephone Services and External Devices](#)
  - [Connect an External TAD](#)
  - [Record an Outgoing Message \(OGM\) on the External TAD](#)
  - [Multi-line Connections \(PBX\)](#)

#### Related Topics:

- [Telephone and Fax Problems](#)

## Connect an External TAD

**Related Models:** MFC-J1300DW

1. Set your external TAD to the minimum number of rings allowed. For more information, contact your telephone provider. (The machine's Ring Delay setting does not apply.)
2. Record the outgoing message on your external TAD.
3. Set the TAD to answer calls.
4. Set the Receive Mode on your machine to [External TAD].



### Related Information

- [External TAD \(Telephone Answering Device\)](#)

#### Related Topics:

- [Receive Modes Overview](#)
- [Choose the Correct Receive Mode](#)
- [Telephone and Fax Problems](#)

## Record an Outgoing Message (OGM) on the External TAD

**Related Models:** MFC-J1300DW

1. Record five seconds of silence at the beginning of your message. This allows your machine time to listen for fax tones.



We recommend beginning your OGM with an initial five second silence because the machine cannot hear fax tones over a loud voice. You may try leaving out this pause, but if your machine has trouble receiving faxes, then you should re-record the OGM to include it.

2. Limit your speaking to 20 seconds.
3. End your 20-second message by giving your Remote Activation Code for people sending manual faxes. For example: "After the beep, leave a message or press \*51 and Start to send a fax."



### Related Information

- [External TAD \(Telephone Answering Device\)](#)

## Multi-line Connections (PBX)

**Related Models:** MFC-J1300DW

We suggest you ask the company that installed your PBX to connect your machine. If you have a multi line system we suggest you ask the installer to connect the unit to the last line on the system. This prevents the machine being activated each time the system receives telephone calls. If all incoming calls will be answered by a switchboard operator we recommend setting the Receive Mode to [Manual].

We cannot guarantee that your machine will operate correctly under all circumstances when connected to a PBX. Any difficulties with sending or receiving faxes should be reported first to the company that handles your PBX.



### Related Information

- [External TAD \(Telephone Answering Device\)](#)

## External and Extension Telephones

- [Connect an External or Extension Telephone](#)
- [Operation from External and Extension Telephones](#)
- [Use Extension Telephones](#)
- [Use the Remote Codes](#)

## Connect an External or Extension Telephone

**Related Models:** MFC-J1300DW

You can connect a separate telephone to your machine as shown in the diagram below.

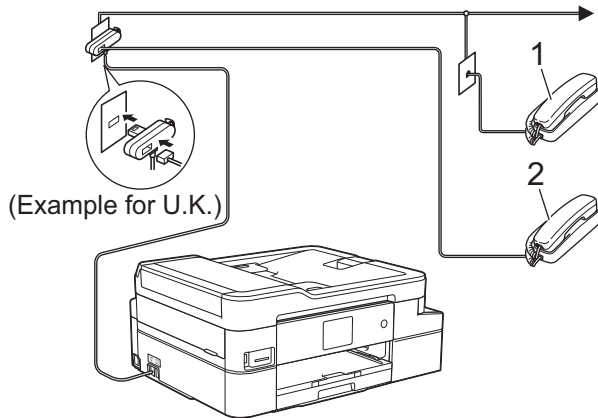

- 1 Extension telephone
- 2 External telephone



Please make sure you use an external telephone with a cable no more than three metres long.



### Related Information

- [External and Extension Telephones](#)

## Operation from External and Extension Telephones

**Related Models:** MFC-J1300DW

If you answer a fax call at an extension or an external telephone, you can make your machine take the call by using the Remote Activation Code. When you press the Remote Activation Code **\*51**, the machine starts to receive the fax.

If the machine answers a voice call and pseudo/double-rings for you to take over, you can take the call at an extension telephone by pressing the Remote Deactivation Code **#51**.

### If you answer a call and no one is on the line:

You should assume that you're receiving a manual fax.

Press **\*51** and wait for the chirp or until the LCD shows [Receiving], and then hang up.



You can also use the Fax Detect feature to make your machine automatically take the call.



### Related Information

- [External and Extension Telephones](#)

#### Related Topics:

- [Set the Number of Rings Before the Machine Answers \(Ring Delay\)](#)
- [Set Fax Detect](#)
- [Set a Remote Access Code](#)
- [Set the F/T Ring Time \(Pseudo/Double-ring\)](#)



## Use Extension Telephones

**Related Models:** MFC-J1300DW

Your premises may already be wired with parallel extension telephones, or you may plan to add extension telephones to your line, as well as your machine. While the simplest arrangement is a straightforward parallel connection, there are some problems with this. The most obvious is inadvertent interruption of a fax transmission caused by someone picking up an extension telephone to make an outgoing call. Also, the remote activation code feature may not operate reliably in such a simple configuration.

This machine also may be set to make a delayed transmission (i.e. a transmission at a pre-set time). This pre-set job may coincide with someone picking up an extension handset.

These problems can easily be eliminated, if you arrange modification of your extension wiring circuit, such that extension devices are connected “downstream” of your machine in a master/slave configuration (see fig. 2). In this configuration the machine can always detect whether a telephone is in use. Thus it will not attempt to seize the line during that time. This is known as “telephone off-hook detection.”

The inadvisable configuration is shown in figure 1, and the recommended master/slave configuration is shown in figure 2.

This new connection configuration can be arranged by contacting BT, Kingston upon Hull Telecommunications, your PBX maintainer or a qualified telephone installation company as appropriate. Simply explained, the extension telephone circuit should be terminated on a normal modular plug (BT 431A style), which in turn should be put into the modular socket of the white “T”-shaped connector provided as part of the line cord assembly.

**Inadvisable connection of extension sockets (Fig. 1.)**

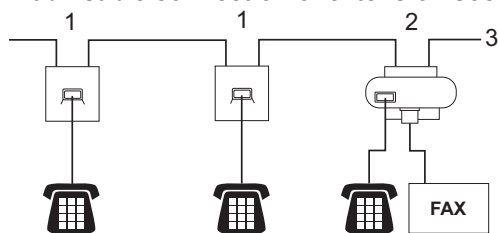

- 1. Extension socket
- 2. Master socket
- 3. Incoming line

**Recommended connection of extension sockets (Fig. 2.)**

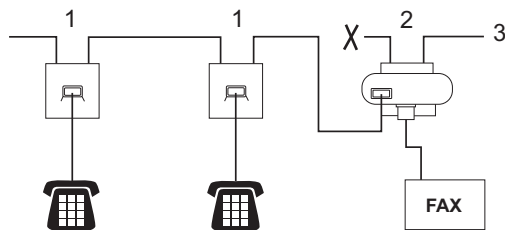

- 1. Extension socket
- 2. Master socket
- 3. Incoming line

The fax machine must be plugged into the master socket.



These telephones are now connected as external devices, because they are connected to the fax machine via the T-connector.



### Related Information

- [External and Extension Telephones](#)

## Use the Remote Codes

Related Models: MFC-J1300DW

### Remote Activation Code

If you answer a fax call on an extension or external telephone, you can tell your machine to receive it by pressing the Remote Activation Code \*51. Wait for the chirping sounds then replace the handset.

If you answer a fax call at the external telephone, you can make the machine receive the fax by pressing the Start button and then selecting the option to receive.

### Remote Deactivation Code

If you receive a voice call and the machine is in F/T mode, it will start to sound the F/T ring (pseudo/double-ring) after the initial Ring Delay. If you pick up the call on an extension telephone you can turn the F/T ring off by pressing #51 (make sure you press this between the rings).

If the machine answers a voice call and pseudo/double-rings for you to take over, you can take the call at the external telephone by pressing [Pickup].

### ✓ Related Information

- [External and Extension Telephones](#)
  - [Change the Remote Codes](#)



#### Related Topics:

- [Set a Remote Access Code](#)
- [Set Fax Detect](#)

## Change the Remote Codes

**Related Models:** MFC-J1300DW

The preset Remote Activation Code is **\*51**. The preset Remote Deactivation Code is **#51**. If you are always disconnected when accessing your External TAD remotely, try changing the three-digit remote codes using the numbers 0-9, \*, #.

1. Press  [Settings] > [All Settings] > [Fax] > [Setup Receive] > [Remote Codes].
2. Do one of the following:
  - To change the Remote Activation Code, press [Act.Code]. Enter the new code, and then press [OK].
  - To change the Remote Deactivation Code, press [Deact.Code]. Enter the new code, and then press [OK].
  - If you do not want to change the Codes, go to the next step.
  - To turn the Remote Codes [Off] (or [On]), press [Remote Codes]. Press [Off] (or [On]).
3. Press .

### Related Information

- [Use the Remote Codes](#)

## Fax Reports

- [Set the Transmission Verification Report's Style](#)
- [Set the Fax Journal's Interval Period](#)
- [Print Reports](#)

## Set the Transmission Verification Report's Style

**Related Models:** MFC-J1300DW

You can use the Transmission Verification Report as proof that you sent a fax. This report lists the receiving party's name or fax number, the time and date of transmission, duration of transmission, number of pages sent, and whether or not the transmission was successful.

There are several settings available for the Transmission Verification Report:

Option	Description
On	Prints a report after every fax you send.
On (+Image)	Prints a report after every fax you send. A portion of the fax's first page appears on the report.
Error only	Prints a report if your fax is unsuccessful due to a transmission error.
Error only (+Image)	Prints a report if your fax is unsuccessful due to a transmission error. A portion of the fax's first page appears on the report.
Off	The report will not be printed.

1. Press  [Settings] > [All Settings] > [Fax] > [Report Setting] > [XMIT Report].

2. Press the option you want.

If you select [On (+Image)] or [Error only (+Image)], the image will not appear on the Transmission Verification Report if Real Time Transmission is set to [On]. The image will not appear on the report when you send a colour fax.

3. Press .

If the transmission is successful, [OK] appears next to [RESULT] on the Transmission Verification Report. If the transmission is not successful, [ERROR] appears next to [RESULT].



### Related Information

- [Fax Reports](#)

## Set the Fax Journal's Interval Period

**Related Models:** MFC-J1300DW

You can set the machine to print a Fax Journal at specific intervals (every 50 faxes, 6, 12 or 24 hours, 2 or 7 days).

1. Press  [Settings] > [All Settings] > [Fax] > [Report Setting] > [Journal Period].
2. Press [Journal Period].
3. Press ▲ or ▼ to select an interval.
  - 6, 12, 24 hours, 2 or 7 days  
The machine will print the report at the selected interval and then erase all fax jobs from the Journal's memory. If the memory becomes full with 200 jobs before the time you selected has passed, the machine will print the Journal early and then erase all fax jobs from the memory. If you want an extra report before it is due to print, you can print it without erasing the jobs.
  - Every 50 Faxes  
The machine will print the Journal when the machine has stored 50 fax jobs.
4. If you selected 6, 12, 24 hours, 2 or 7 days, press [Time] and enter the time of day using the touchscreen. Press [OK].
5. If you selected [Every 7 Days], press [Day]. Press ▲ or ▼ to display the [Every Monday], [Every Tuesday], [Every Wednesday], [Every Thursday], [Every Friday], [Every Saturday] or [Every Sunday] option, and then press the first day of the seven-day countdown.
6. Press .



### Related Information

- [Fax Reports](#)

#### Related Topics:

- [Set the Machine to Power Off Automatically](#)

## PC-FAX

**Related Models:** MFC-J1300DW

- [PC-FAX for Windows](#)
- [PC-FAX for Mac](#)

## PC-FAX for Windows

- [PC-FAX Overview \(Windows\)](#)
- [Send a Fax Using PC-FAX \(Windows\)](#)
- [Receive Faxes on Your Computer \(Windows\)](#)



## PC-FAX Overview (Windows)

**Related Models:** MFC-J1300DW

Reduce paper consumption and save time by using Brother's PC-FAX software to send faxes directly from your machine.



- [Configure PC-FAX \(Windows\)](#)
- [Configure your PC-Fax Address Book \(Windows\)](#)

## Configure PC-FAX (Windows)

**Related Models:** MFC-J1300DW

Before sending faxes using PC-FAX, personalise the send options in each tab of the **PC-FAX Setup** dialog box.

1. Do one of the following:

- Windows 7

Click  (**Start**) > **All Programs** > **Brother** > **Brother Utilities**.

Click the drop-down list and select your model name (if not already selected). Click **PC-FAX** in the left navigation bar, and then click **Setup Sending**.

- Windows 8 and Windows 10

Launch  (**Brother Utilities**), and then click the drop-down list and select your model name (if not already selected). Click **PC-FAX** in the left navigation bar, and then click **Setup Sending**.

The **PC-FAX Setup** dialog box appears.

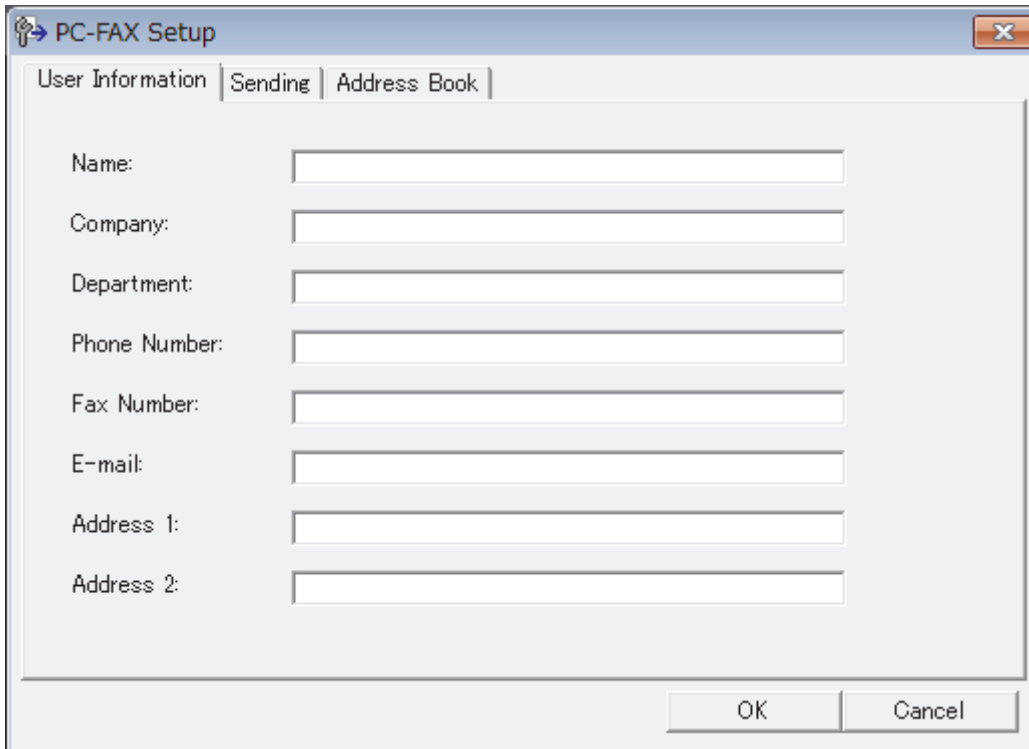

2. Do one of the following:

- Click the **User Information** tab, and then type your user information in the fields.



Each Microsoft account can have its own customised **User Information** screen for custom fax headers and cover pages.

- Click the **Sending** tab, and then type the number needed to access an outside line (if needed) in the **Outside line access** field. Select the **Include header** check box to include the header information.
- Click the **Address Book** tab, and then select the address book you want to use for PC-FAX from the **Select Address Book** drop-down list.

3. Click **OK**.



### Related Information

- [PC-FAX Overview \(Windows\)](#)

## Configure your PC-Fax Address Book (Windows)

**Related Models:** MFC-J1300DW

Add, edit and delete members and groups to personalise your Brother **Address Book**.

- [Add a Member to your PC-FAX Address Book \(Windows\)](#)
- [Create a Group in your PC-FAX Address Book \(Windows\)](#)
- [Edit Member or Group Information in your PC-FAX Address Book \(Windows\)](#)
- [Delete a Member or Group in your PC-FAX Address Book \(Windows\)](#)
- [Export your PC-FAX Address Book \(Windows\)](#)
- [Import Information to your PC-FAX Address Book \(Windows\)](#)

## Add a Member to your PC-FAX Address Book (Windows)

**Related Models:** MFC-J1300DW

Add new people and their fax information to the PC-Fax Address Book if you want to send a fax using Brother PC-Fax software.

1. Do one of the following:

- Windows 7

Click  (**Start**) > **All Programs** > **Brother** > **Brother Utilities**.

Click the drop-down list and select your model name (if not already selected). Click **PC-FAX** in the left navigation bar, and then click **Address Book (Send)**.

- Windows 8 and Windows 10

Launch  (**Brother Utilities**), and then click the drop-down list and select your model name (if not already selected). Click **PC-FAX** in the left navigation bar, and then click **Address Book (Send)**.

The **Address Book** dialog box appears.

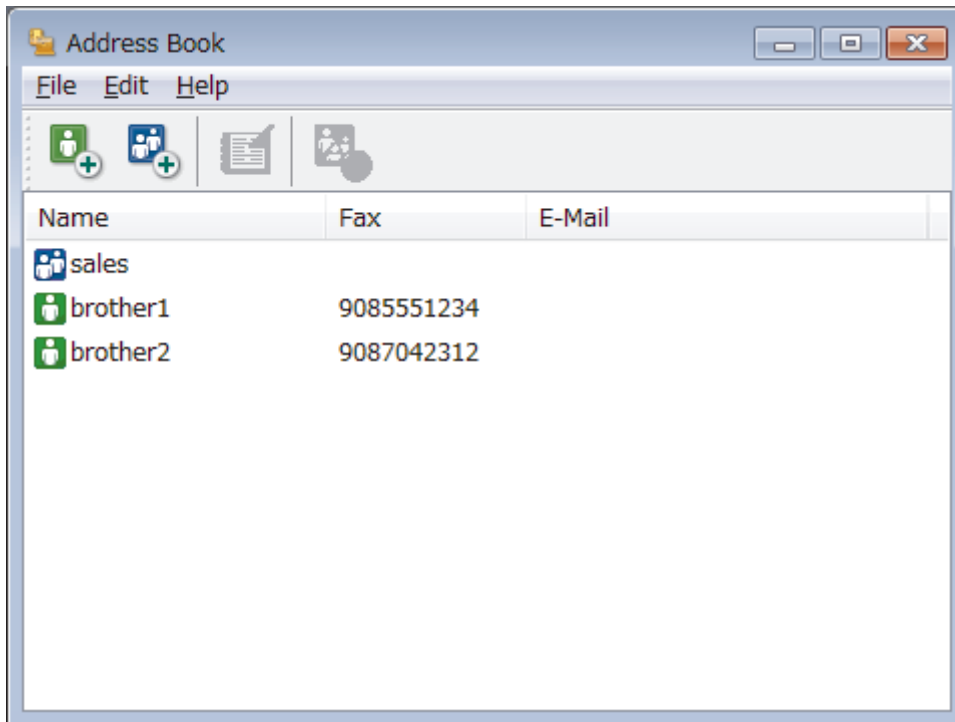

2. Click .

The **Address Book Member Setup** dialog box appears.

- Type the member's information in the corresponding fields. Only the **Name** field is required.
- Click **OK**.

### Related Information

- [Configure your PC-Fax Address Book \(Windows\)](#)

## Create a Group in your PC-FAX Address Book (Windows)

**Related Models:** MFC-J1300DW

Create a group to broadcast the same PC-FAX to several recipients at one time.

1. Do one of the following:

- Windows 7

Click  (**Start**) > **All Programs** > **Brother** > **Brother Utilities**.

Click the drop-down list and select your model name (if not already selected). Click **PC-FAX** in the left navigation bar, and then click **Address Book (Send)**.

- Windows 8 and Windows 10

Launch  (**Brother Utilities**), and then click the drop-down list and select your model name (if not already selected). Click **PC-FAX** in the left navigation bar, and then click **Address Book (Send)**.

The **Address Book** dialog box appears.

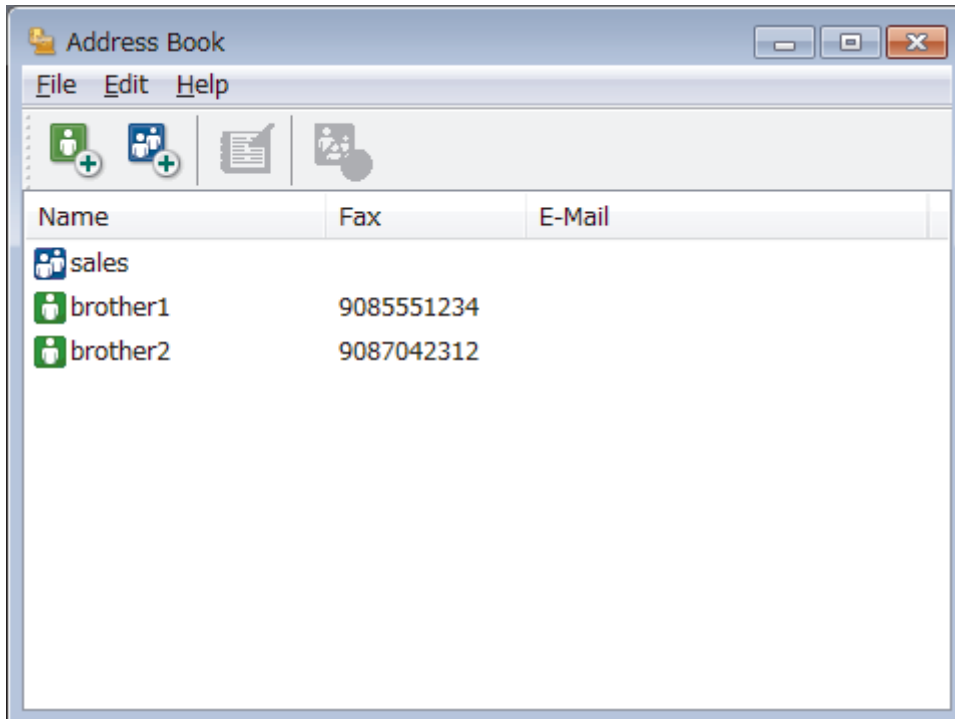

2. Click .

The **Address Book Group Setup** dialog box appears.

3. Type the name of the new group in the **Group Name** field.

4. In the **Available Names** field, select each name you want to include in the group, and then click **Add >>**.

Members added to the group appear in the **Group Members** box.

5. When finished, click **OK**.



Each group can contain up to 50 members.



### Related Information

- [Configure your PC-Fax Address Book \(Windows\)](#)

## Edit Member or Group Information in your PC-FAX Address Book (Windows)

**Related Models:** MFC-J1300DW

1. Do one of the following:

- Windows 7

Click  (**Start**) > **All Programs** > **Brother** > **Brother Utilities**.

Click the drop-down list and select your model name (if not already selected). Click **PC-FAX** in the left navigation bar, and then click **Address Book (Send)**.

- Windows 8 and Windows 10

Launch  (**Brother Utilities**), and then click the drop-down list and select your model name (if not already selected). Click **PC-FAX** in the left navigation bar, and then click **Address Book (Send)**.

The **Address Book** dialog box appears.

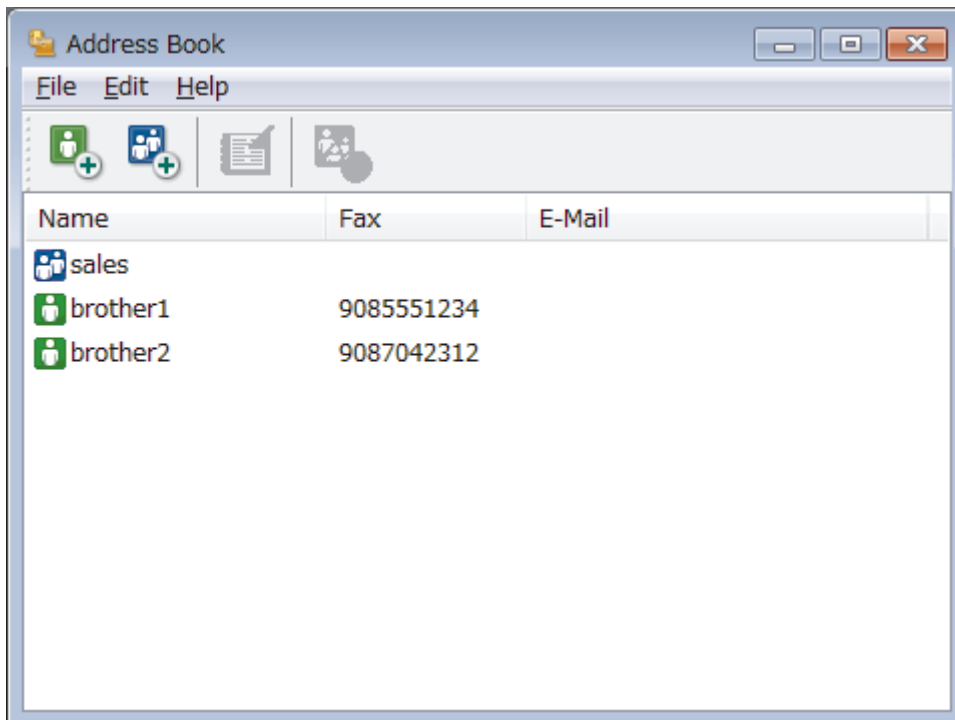

- Select the member or group you want to edit.
- Click  (**Properties**).
- Change the member or group information.
- Click **OK**.

### Related Information

- [Configure your PC-Fax Address Book \(Windows\)](#)

## Delete a Member or Group in your PC-FAX Address Book (Windows)

**Related Models:** MFC-J1300DW

1. Do one of the following:

- Windows 7

Click  (**Start**) > **All Programs** > **Brother** > **Brother Utilities**.

Click the drop-down list and select your model name (if not already selected). Click **PC-FAX** in the left navigation bar, and then click **Address Book (Send)**.

- Windows 8 and Windows 10

Launch  (**Brother Utilities**), and then click the drop-down list and select your model name (if not already selected). Click **PC-FAX** in the left navigation bar, and then click **Address Book (Send)**.

The **Address Book** dialog box appears.

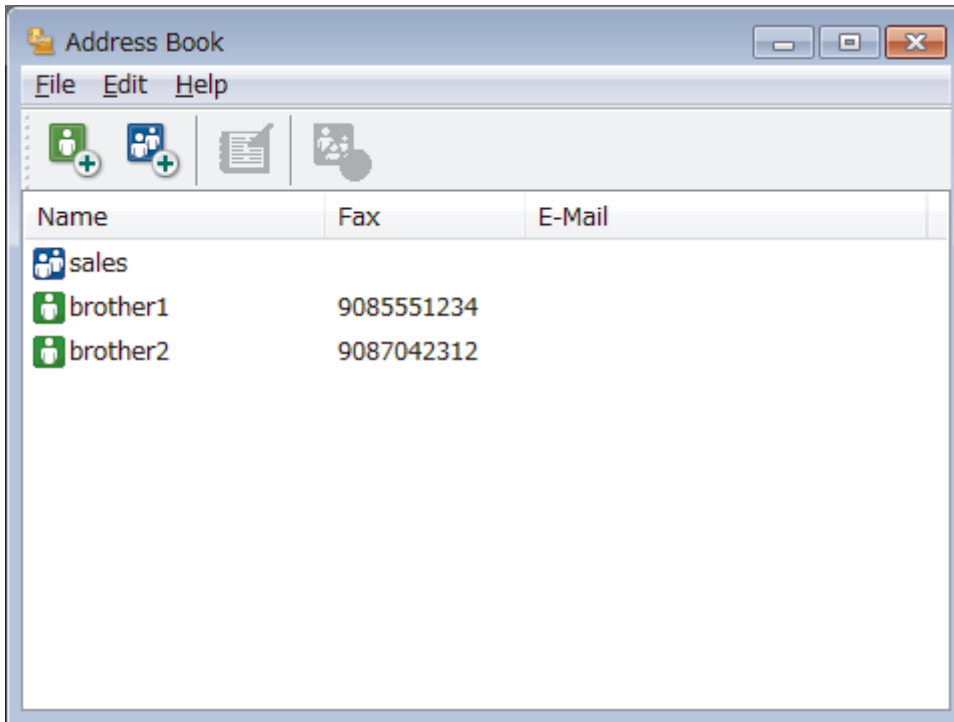

2. Select the member or group you want to delete.

3. Click  (**Delete**).

4. When the confirmation dialog box appears, click **OK**.

### Related Information

- [Configure your PC-Fax Address Book \(Windows\)](#)

## Export your PC-FAX Address Book (Windows)

Related Models: MFC-J1300DW

You can export the Address Book as an ASCII text file (\*.csv), a vCard (an electronic business card), or **Remote Setup Dial Data** and save it on your computer.

- You cannot export the group settings when you export the **Address Book** data.

1. Do one of the following:

- Windows 7

Click  (**Start**) > **All Programs** > **Brother** > **Brother Utilities**.

Click the drop-down list and select your model name (if not already selected). Click **PC-FAX** in the left navigation bar, and then click **Address Book (Send)**.

- Windows 8 and Windows 10

Launch  (**Brother Utilities**), and then click the drop-down list and select your model name (if not already selected). Click **PC-FAX** in the left navigation bar, and then click **Address Book (Send)**.

The **Address Book** dialog box appears.

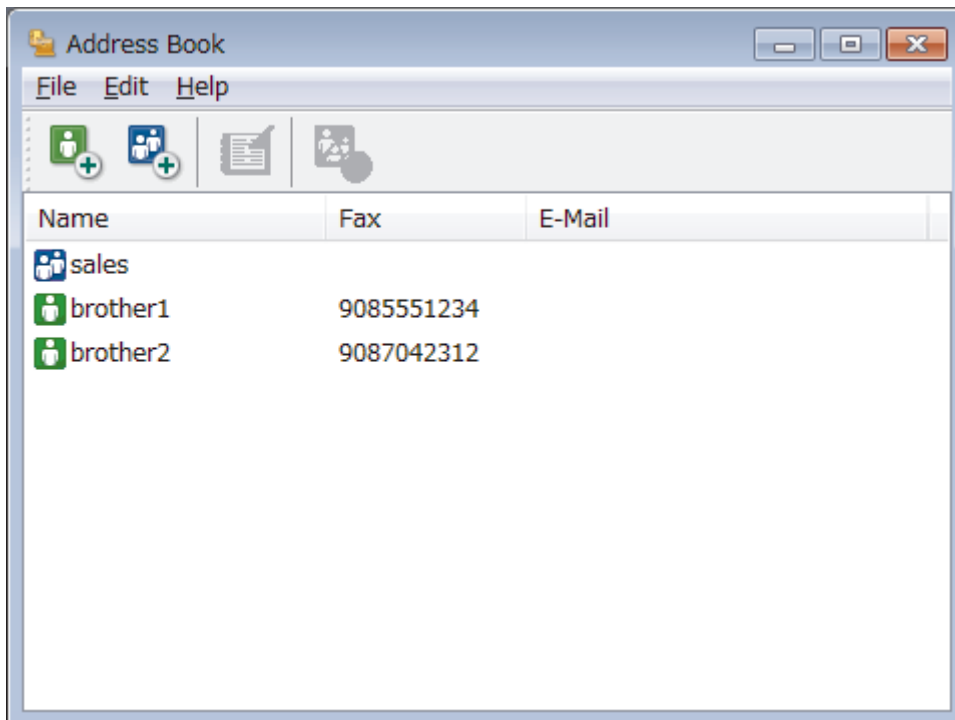

2. Click the **File** menu, and then select **Export**.

3. Select one of the following:

- Text**

The **Select Items** dialog box appears. Go to step 4.

- vCard**

You must select the member you want to export from your address book before selecting this option.

Browse to the folder where you want to save the vCard, type the vCard name in the **File name** field, and then click **Save**.

- Remote Setup Dial Data**

Browse to the folder where you want to save the data, type the file name in the **File name** field, and then click **Save**.



---

4. In the **Available Items** field, select the data you want to export, and then click **Add >>**.



Select and add the items in the order you want them listed.

5. If you are exporting to an ASCII file, under the **Divide Character** section, select the **Tab** or **Comma** option to separate the data fields.
6. Click **OK**.
7. Browse to the folder on your computer where you want to save the data, type the file name, and then click **Save**.



### Related Information

- [Configure your PC-Fax Address Book \(Windows\)](#)

## Import Information to your PC-FAX Address Book (Windows)

**Related Models:** MFC-J1300DW

You can import ASCII text files (\*.csv), vCards (electronic business cards), or **Remote Setup Dial Data** into your Address Book.

1. Do one of the following:

- Windows 7

Click  (**Start**) > **All Programs** > **Brother** > **Brother Utilities**.

Click the drop-down list and select your model name (if not already selected). Click **PC-FAX** in the left navigation bar, and then click **Address Book (Send)**.

- Windows 8 and Windows 10

Launch  (**Brother Utilities**), and then click the drop-down list and select your model name (if not already selected). Click **PC-FAX** in the left navigation bar, and then click **Address Book (Send)**.

The **Address Book** dialog box appears.

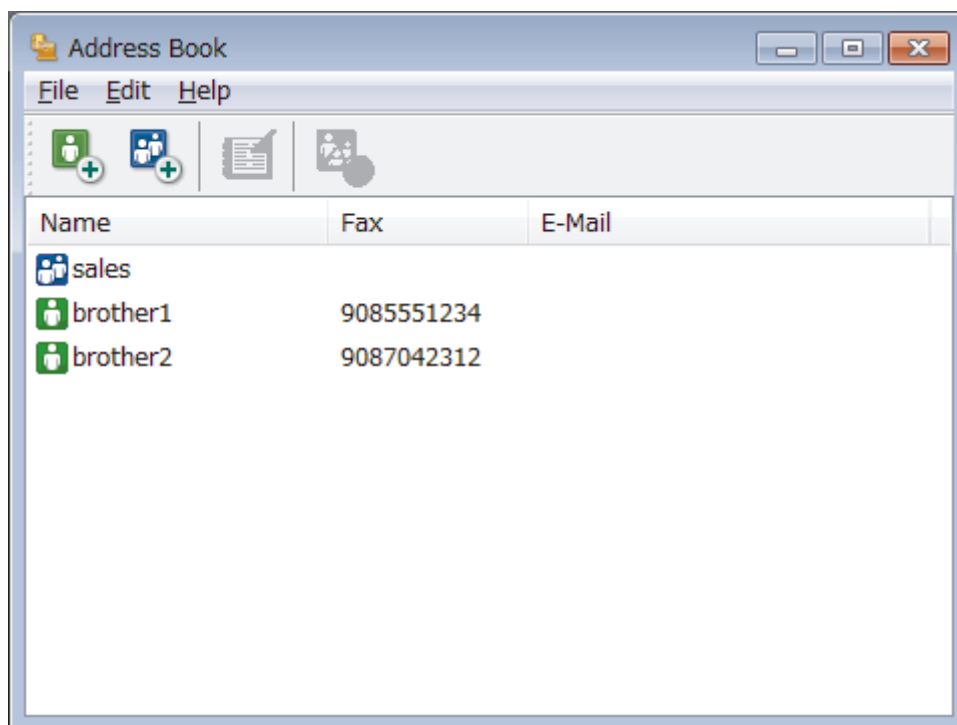

2. Click the **File** menu, and then select **Import**.

3. Select one of the following:

- Text**

The **Select Items** dialog box appears. Go to step 4.

- vCard**

Go to step 7.

- Remote Setup Dial Data**

Go to step 7.

4. In the **Available Items** field, select the data you want to import, and then click **Add >>**.



You must select and add fields from the **Available Items** list in the same order they are listed in the import text file.

- 
5. If you are importing an ASCII file, under the **Divide Character** section, select the **Tab** or **Comma** option to separate the data fields.
  6. Click **OK**.
  7. Browse to the folder where you want to import the data, type the file name, and then click **Open**.



### Related Information

- [Configure your PC-Fax Address Book \(Windows\)](#)
-

## Send a Fax Using PC-FAX (Windows)

Related Models: MFC-J1300DW

PC-FAX supports only monochrome faxes. A monochrome fax will be sent even if the original data is colour and the receiving fax machine supports colour faxes.

1. Create a file in any application on your computer.
2. Select the print command in your application.
3. Select **Brother PC-FAX** as your printer, and then complete your print operation.

The **Brother PC-FAX** dialog box appears.

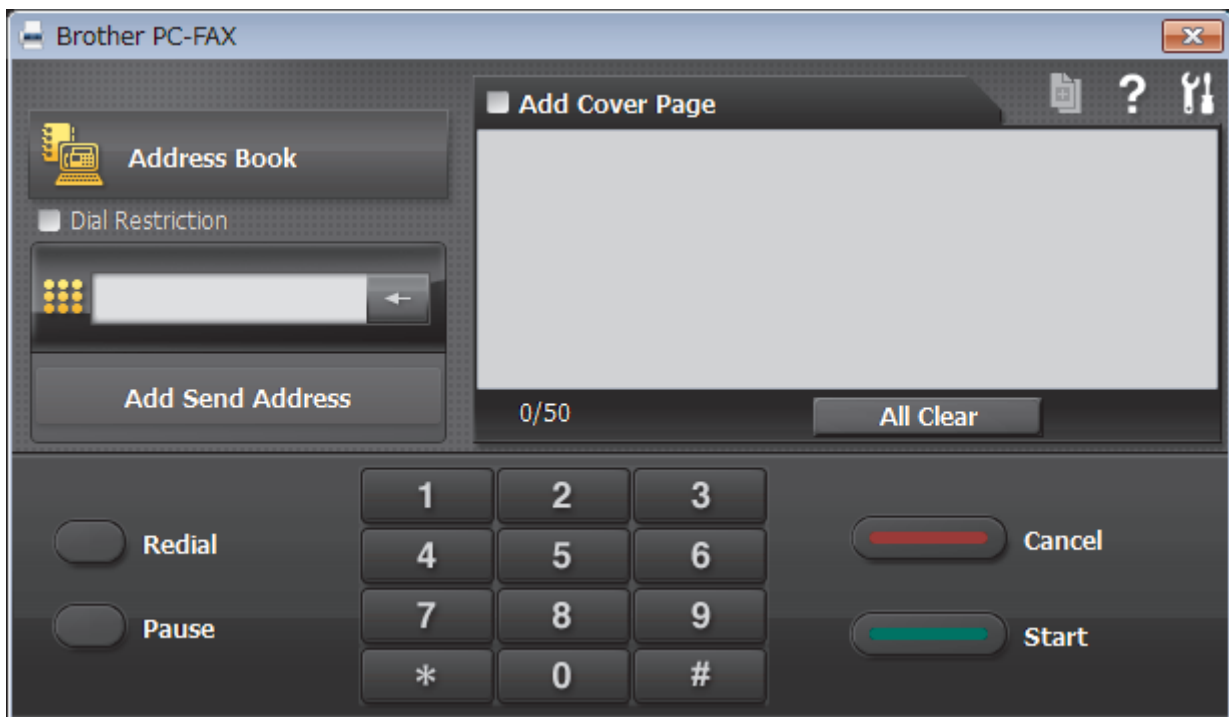

4. Type a fax number using one of the following methods:
  - Click the numbers on the dial pad to type the number, and then click **Add Send Address**.

 If you select the **Dial Restriction** check box, a confirmation dialog box will appear for you to re-type the fax number using the keyboard. This feature helps to prevent transmissions to the wrong destination.

- Click the **Address Book** button, and then select a member or group from the Address Book.

 If you make a mistake, click **All Clear** to delete all entries.

5. To include a cover page, select the **Add Cover Page** check box. You can also click  to create or edit a cover page.
6. Click **Start** to send the fax.

- To cancel the fax, click **Cancel**.
- To redial a number, click **Redial** to show the last five fax numbers, select a number, and then click **Start**.

### Related Information

- [PC-FAX for Windows](#)

## Receive Faxes on Your Computer (Windows)

**Related Models:** MFC-J1300DW

Use Brother's PC-FAX software to receive faxes on your computer, screen them and print only those faxes you want.



- [Receive Faxes Using PC-FAX Receive \(Windows\)](#)

## Receive Faxes Using PC-FAX Receive (Windows)

**Related Models:** MFC-J1300DW

Brother's PC-FAX Receive software lets you view and store faxes on your computer. It is automatically installed when you install the Brother software and drivers and works on locally or network-connected machines.

- PC-FAX Receive supports only monochrome faxes. When you receive a colour fax, your machine prints the colour fax at your machine but does not send the fax to your computer.

When you turn off your computer, your machine will continue to receive and store faxes in your Brother machine's memory. The machine's LCD will display the number of stored faxes received. When you start this application, the software will transfer all received faxes to your computer at once. You can enable the Backup Print option if you want the machine to print a copy of the fax before the fax is sent to your computer, or before the computer is switched off. You can configure the Backup Print settings from your Brother machine.



### Related Information

- [Receive Faxes on Your Computer \(Windows\)](#)
  - [Run Brother's PC-FAX Receive on Your Computer \(Windows\)](#)
  - [View Received PC-FAX Messages \(Windows\)](#)

### Related Topics:

- [Use PC-Fax Receive to Transfer Received Faxes to Your Computer \(Windows only\)](#)

## Run Brother's PC-FAX Receive on Your Computer (Windows)

Related Models: MFC-J1300DW



We recommend selecting the **Start PC-FAX Receive on computer startup** check box so that the software runs automatically and can transfer any faxes upon computer startup.

1. Do one of the following:

- Windows 7

Click  (**Start**) > **All Programs** > **Brother** > **Brother Utilities**.

Click the drop-down list and select your model name (if not already selected). Click **PC-FAX** in the left navigation bar, and then click **Receive**.

- Windows 8 and Windows 10

Launch  (**Brother Utilities**), and then click the drop-down list and select your model name (if not already selected). Click **PC-FAX** in the left navigation bar, and then click **Receive**.

2. Confirm the message and click **Yes**.

The **PC-FAX Receive** window appears. The  (**PC-FAX Receive**) icon also appears in your computer task tray.



### Related Information

- [Receive Faxes Using PC-FAX Receive \(Windows\)](#)
  - [Set Up Your Computer for PC-FAX Receiving \(Windows\)](#)
  - [Add Your Brother Machine to PC-FAX Receiving \(Windows\)](#)

## Set Up Your Computer for PC-FAX Receiving (Windows)

Related Models: MFC-J1300DW

1. Double-click the  (**PC-FAX Receive**) icon in your computer task tray.

The **PC-FAX Receive** window appears.

2. Click **Settings**.
3. Configure these options as needed:

### Preferences

Configure to start PC-FAX Receive automatically when you start Windows.

### Save

Configure the path to save PC-FAX files and select the received document format.

### Upload to

Configure the path to the SharePoint server and select the option to upload automatically or manually (available only for Administrators).

### Device

Select the Brother machine that you want to receive PC-FAX.

### Lock (available only for Administrators)

Restrict users who do not have administrator privileges from configuring the settings options shown above.

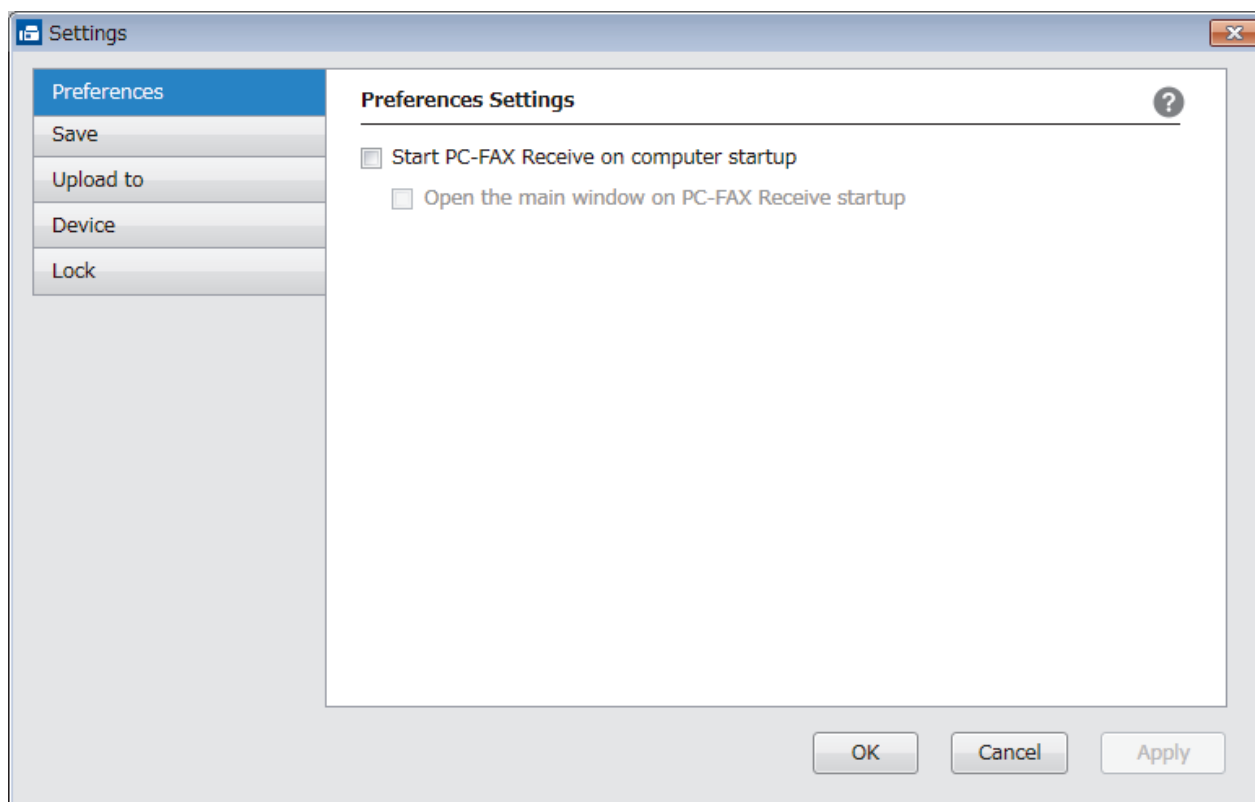

4. Click **OK**.

### Related Information

- [Run Brother's PC-FAX Receive on Your Computer \(Windows\)](#)



## Add Your Brother Machine to PC-FAX Receiving (Windows)

**Related Models:** MFC-J1300DW

- If you installed the machine following the instructions for a network user, then the machine should already be configured for your network.

1. Double-click the  (**PC-FAX Receive**) icon in your computer task tray.

The **PC-FAX Receive** window appears.

2. Click **Settings**.
3. Click **Device > Add**.

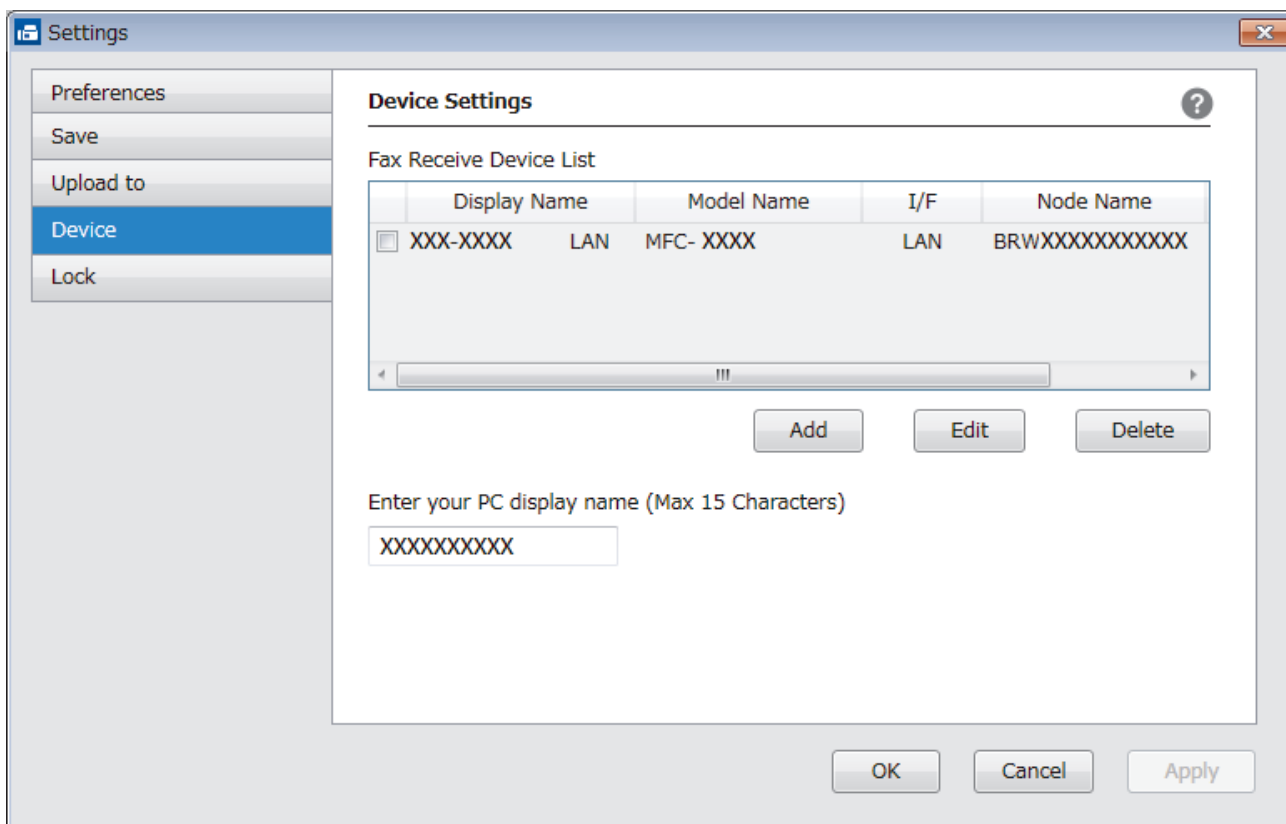

4. Select the appropriate connection method.

### Select your machine from the automatic search results below.

Connected Brother machines will be displayed. Select a device from the list. Click **OK**.

### Specify your machine by IP address

Type the machine's IP address in the **IP Address** field, and then click **OK**.

5. To change the computer name that will appear on the machine's LCD, type the new name in the **Enter your PC display name (Max 15 Characters)** field.
6. Click **OK**.





### Related Information

- [Run Brother's PC-FAX Receive on Your Computer \(Windows\)](#)

## View Received PC-FAX Messages (Windows)

Related Models: MFC-J1300DW

### Receiving Status

Icon	Indicated Status
	Standby mode No unread messages
	Receiving messages
	Messages received Unread messages

1. Double-click the  (PC-FAX Receive) icon in your computer task tray.

The PC-FAX Receive window appears.

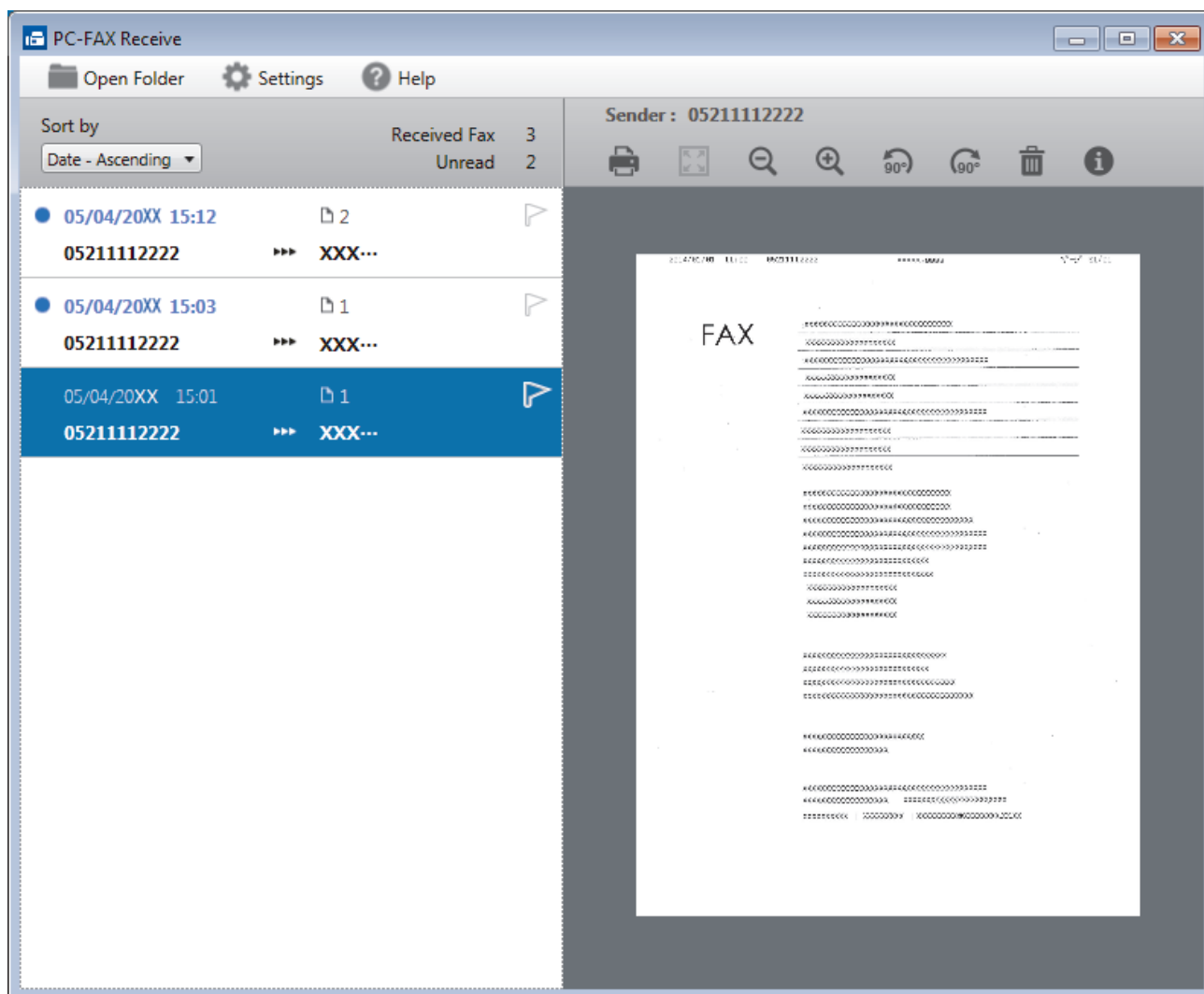

2. Click any faxes in the list to view them.
3. When finished, click  in the right top corner of the window to close it.



Even after closing the window, PC-FAX Receive is active and the  (PC-FAX Receive) icon will remain in your computer task tray. To close PC-FAX Receive, click the icon in the computer task tray and click **Close**.

---



### Related Information

- [Receive Faxes Using PC-FAX Receive \(Windows\)](#)
-

## PC-FAX for Mac

Use Brother's PC-FAX software to send faxes directly from your Mac without printing them. This feature helps reduce your paper consumption and save time.

- [Send Faxes from Your Application \(Mac\)](#)

## Send Faxes from Your Application (Mac)

Related Models: MFC-J1300DW

PC-FAX supports only monochrome faxes. A monochrome fax will be sent even if the original data is colour and the receiving fax machine supports colour faxes.

1. Create a document in a Mac application.
2. From an application, such as Apple TextEdit, click the **File** menu, and then select **Print**.
3. Click the application pop-up menu, and then select the **Send Fax** option.

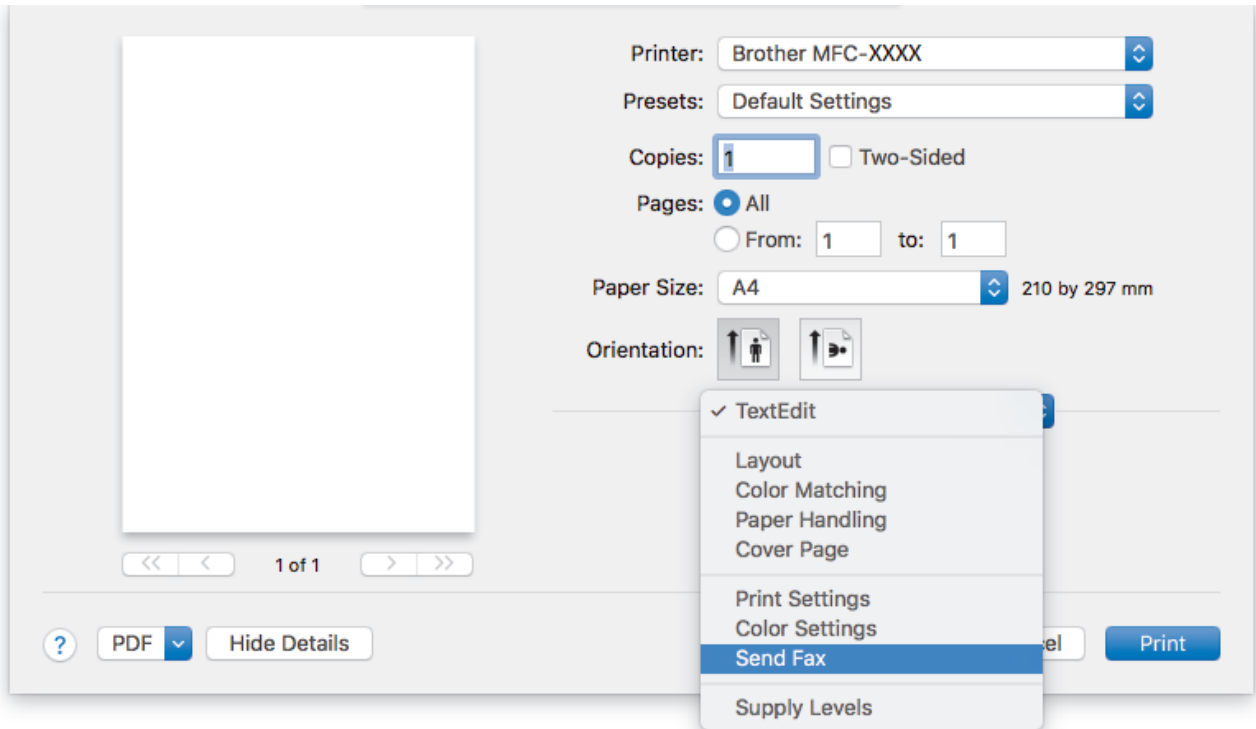

4. Click the **Output** pop-up menu, and then select the **Facsimile** option.

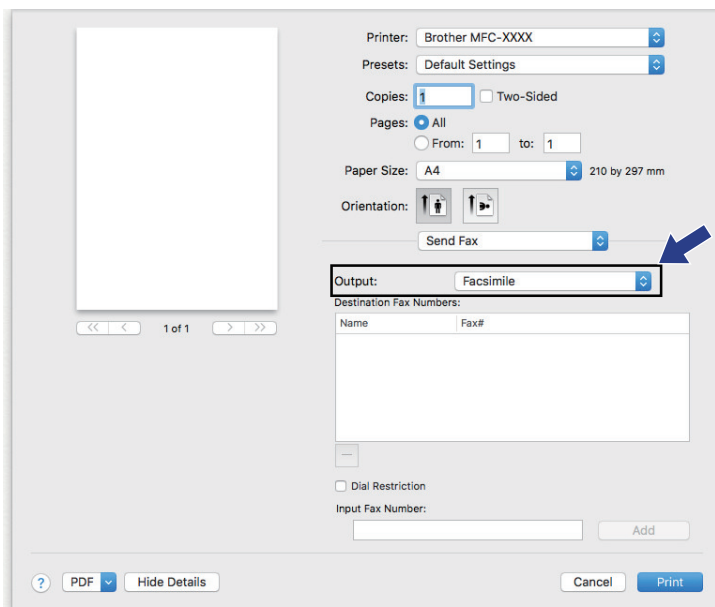

5. Type a fax number in the **Input Fax Number** field, and then click **Add**.  
The fax number is displayed in the **Destination Fax Numbers** field.



To send a fax to more than one number, click the **Add** button after entering the first fax number and type the next fax number. The destination fax numbers will be listed in the **Destination Fax Numbers** field.

The screenshot shows a fax software interface with the following elements:

- Printer:** Brother MFC-XXXX
- Presets:** Default Settings
- Copies:** 1, with a checkbox for Two-Sided.
- Pages:** All, with radio buttons for From: 1 to: 1.
- Paper Size:** A4, 210 by 297 mm.
- Orientation:** Portrait/landscape icons.
- Send Fax:** A dropdown menu.
- Output:** Facsimile.
- Destination Fax Numbers:** A table with columns for Name and Fax#. One entry is visible: Name (blank), Fax# 905551234.
- Input Fax Number:** 9087042312.
- Add:** A button next to the input field, highlighted with a blue arrow.
- Buttons:** Cancel, Print, PDF, Hide Details.

6. Click **Print** to send the fax.



## Related Information

- [PC-FAX for Mac](#)

## PhotoCapture Center

- [Print Photos Directly from Media](#)
- [Copy Photos from Media to a Computer](#)
- [Print Photos from ControlCenter4 \(Windows\)](#)

## Print Photos Directly from Media

When your machine is *not* connected to your computer, you can print photos directly from digital camera media or a USB Flash memory drive, scan documents and save them directly to a memory card or USB flash drive. When your machine is connected to a computer, you can use your computer to access a memory card or USB flash drive inserted in the front of the machine.

- [Compatible Media](#)
- [Important Information about Photo Printing](#)
- [Print Photos from Media on the Brother Machine](#)







## Compatible Media

Your Brother machine has media drives (slots) for use with common data storage and digital camera media.

### IMPORTANT

The USB direct interface supports only USB flash drives and digital cameras that use the USB mass storage standard. Other USB devices are not supported.

Compatible Media	
USB flash drive	
SD Memory Card SDHC Memory Card SDXC Memory Card MultiMediaCard MultiMediaCard plus	 
miniSD (Adapter required) miniSDHC (Adapter required) microSD (Adapter required) microSDHC (Adapter required) MultiMediaCard mobile (Adapter required)	



### Related Information

- [Save Scanned Data to a Memory Card or USB Flash Drive](#)
- [Print Photos Directly from Media](#)

## Important Information about Photo Printing



USB flash drive support is available only for certain models.

Your machine is designed to be compatible with modern digital camera image files, memory cards and USB flash drives. Read the points below to avoid errors:

- The image file extension must be .JPG (other image file extensions like .JPEG, .TIF, .GIF and so on will not be recognised).
- Direct photo printing must be performed separately from photo printing operations using the computer. (Simultaneous operation is not available.)
- The machine can read up to 999 files <sup>1</sup> on a memory card or USB flash drive.

Be aware of the following:

- When printing an index or image, the machine will print all the valid images, even if one or more images have been corrupted. Corrupted images will not be printed.
- (Memory card users)

Your machine is designed to read memory cards that have been formatted by a digital camera.

When a digital camera formats a memory card, it creates a special folder into which it copies image data. If you must use your computer to modify the image data stored on a memory card, we recommend that you do not modify the folder structure created by the digital camera. When saving new or modified image files to the memory card, we also recommend you use the same folder your digital camera uses. If the data is not saved to the same folder, the machine may not be able to read the file or print the image.

- (USB flash drive users)

Your machine supports USB flash drives that have been formatted by Windows.



### Related Information

- [Print Photos Directly from Media](#)

<sup>1</sup> The folder inside memory cards or USB flash drives is also counted.

## Print Photos from Media on the Brother Machine

- [Preview and Print Photos from Media](#)
- [Print a Photo Index Sheet \(Thumbnails\) from Media](#)
- [Print Photos by Image Number](#)
- [Print ID Photos](#)
- [Print Photos with Auto Cropping](#)
- [Print Borderless Photos from Media](#)
- [Print the Date from Your Photo's Data](#)
- [Print Settings for Photos](#)

## Preview and Print Photos from Media

Preview your photos on the LCD before you print them.

- If your photos are large files, there may be a delay before each photo is displayed.
1. Put the memory card or USB flash drive in the correct slot.

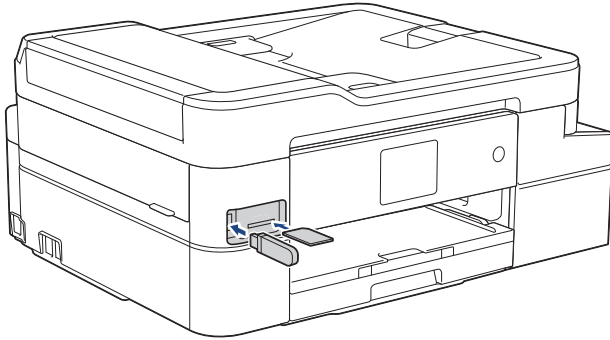

2. Press [Photo] > [Select Files].
3. Press ◀ or ▶ to display the photo you want to print, and then press it.



To print all photos, press [Print All], and then press [Yes] to confirm.

4. Enter the number of copies in one of the following ways:
  - Press [-] or [+] on the touchscreen.
  - Press **x01** to display the keyboard on the touchscreen, and then enter the number of copies using the touchscreen keyboard. Press [OK].
5. Press [OK].
6. Repeat the last three steps until you have selected all the photos you want to print.
7. Press [OK].
8. Read and confirm the displayed list of options.
9. To change the print settings, press [Print Settings].  
When finished, press [OK].
10. Press [Start].



### Related Information

- [Print Photos from Media on the Brother Machine](#)

#### Related Topics:

- [Print Settings for Photos](#)

## Print a Photo Index Sheet (Thumbnails) from Media

Print a photo Index Sheet to see small preview versions of all pictures on your memory card or USB flash drive.



- The machine assigns numbers for images (such as No.1, No.2, No.3, and so on).  
The machine does not recognise any other numbers or file names that your digital camera or computer has used to identify the pictures.
- Only file names that are 20 characters or less will be printed correctly on the index sheet.
- File names cannot be printed correctly if they contain non-alphanumeric characters, but non-alphanumeric characters do not affect photo print settings.

1. Put the memory card or USB flash drive in the correct slot.
2. Press [Photo] > [Index Print] > [Print Index Sheet].
3. If you want to change the print settings, press [Print Settings].

When finished, press [OK].

Option	Description
Paper Type	Select the paper type.
Paper Size	Select the paper size.

4. Press [Start].



### Related Information

- [Print Photos from Media on the Brother Machine](#)

#### Related Topics:

- [Print Photos by Image Number](#)

## Print Photos by Image Number

Before you can print an individual image, you must print the photo Index Sheet (thumbnails) to know the image number.

1. Put the memory card or USB flash drive in the correct slot.
2. Press [Photo] > [Index Print] > [Print Photos].
3. Enter the image numbers you want to print using the touchscreen. After you have selected the image numbers, press [OK].



- Enter multiple numbers at one time using a comma or a hyphen. For example, enter **1, 3, 6** to print images No.1, No.3 and No.6. Print a range of images using a hyphen. For example, enter **1-5** to print images No.1 to No.5.
- Enter up to 12 characters (including commas and hyphens) for the image numbers you want to print.

4. Enter the number of copies in one of the following ways:
  - Press [-] or [+] on the touchscreen.
  - Press  x01 to display the keyboard on the touchscreen, and then enter the number of copies using the touchscreen keyboard. Press [OK].
5. To change the print settings, press [Print Settings].  
When finished, press [OK].
6. Press [Start].



### Related Information

- [Print Photos from Media on the Brother Machine](#)

#### Related Topics:

- [Print a Photo Index Sheet \(Thumbnails\) from Media](#)
- [Print Settings for Photos](#)

## Print ID Photos

Select a photo stored in a memory card or USB flash drive and print ID photos for your resume, passport and so on. You can print four ID photos on one sheet of paper, and crop large images to preset sizes.

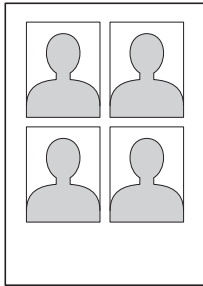

Only one photo will be printed when you select the [2x2inch] or [50x70mm] option in the ID Photo Size setting, and the [10x15cm] option in the Paper Size setting.

1. Put the memory card or USB flash drive in the correct slot.
2. Press [Photo] > [ID Photo Print].
3. Press ◀ or ▶ to display the photo you want, and then press it.
4. Press ▲ or ▼ to adjust the size of the crop you want, and then press it.
5. Rotate the image if needed by pressing .
6. Press [OK].
7. To change the print settings, press [Print Settings].

When finished, press [OK].

Option	Description
Print Quality	Select the print resolution for your type of document.
Paper Type	Select the paper type.
Paper Size	Select the paper size.

8. Press [Start].



### Related Information

- [Print Photos from Media on the Brother Machine](#)

## Print Photos with Auto Cropping

If your photo is too long or too wide to fit the space in your layout, part of the image will be cropped.

- The factory setting is On. To print the whole image, change this setting to Off.
- If you set the [Cropping] setting to Off, set the [Borderless] setting to Off, also.

### Cropping: On

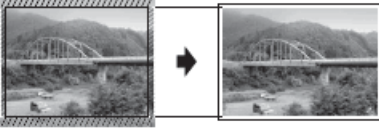

### Cropping: Off



1. Put the memory card or USB flash drive in the correct slot.
2. Press [Photo] > [Select Files].
3. Press ◀ or ▶ to display each photo. When the photo you want appears, press it, and then press [OK].
4. Press [OK].
5. Press [Print Settings] > [Cropping].
6. Press [On] (or [Off]).
7. When finished, press  or [OK].
8. Press [Start].



### Related Information

- [Print Photos from Media on the Brother Machine](#)

#### Related Topics:

- [Other Problems](#)



## Print Borderless Photos from Media

This feature expands the printable area to the edges of the paper. Printing time will be slower.

1. Put the memory card or USB flash drive in the correct slot.
2. Press [Photo] > [Select Files].
3. Press ◀ or ▶ to display each photo. When the photo you want appears, press it, and then press [OK].
4. Press [OK].
5. Press [Print Settings] > [Borderless].
6. Press [On] (or [Off]).
7. When finished, press  or [OK].
8. Press [Start].

### Related Information

- [Print Photos from Media on the Brother Machine](#)

#### **Related Topics:**

- [Other Problems](#)

## Print the Date from Your Photo's Data

Print the date if it is already in your photo's information. The date will be printed on the lower-right corner. To use this setting, the photo must include the date.

1. Put the memory card or USB flash drive in the correct slot.
2. Press [Photo] > [Select Files].
3. Press ◀ or ▶ to display each photo. When the photo you want appears, press it, and then press [OK].
4. Press [OK].
5. Press [Print Settings] > [Date Print].
6. Press [On] (or [Off]).
7. When finished, press  or [OK].
8. Press [Start].



### Related Information

- [Print Photos from Media on the Brother Machine](#)

## Print Settings for Photos

Press the [Print Settings] option to display the settings shown in the table.

Option	Description
Print Quality	Select the print resolution for your type of document. When you select the Inkjet Paper option in the Paper Type setting, you can select only Fine.
Paper Type	Select the paper type.
Paper Size	Select the paper size.
Print Layout	Select the print layout.
Brightness	Adjust the brightness.
Contrast	Adjust the contrast. Increasing the contrast will make an image look sharper and more vivid.
Cropping	Crop the image around the margin to fit the paper size or print size. Turn this feature off when you want to print whole images or prevent unwanted cropping.
Borderless	Expand the printable area to fit the edges of the paper.
Date Print	Print the date on your photo.
Set New Default	Save the print settings you use most often by setting them as the defaults.
Factory Reset	Restore any changed print settings back to the factory settings.



### Related Information

- [Print Photos from Media on the Brother Machine](#)

#### Related Topics:

- [Preview and Print Photos from Media](#)
- [Print Photos by Image Number](#)

## Copy Photos from Media to a Computer

If you would like to copy photos stored in a memory card or USB flash drive to a folder on your computer, follow the steps for your connection type and Operating System.

- [Before Copying Photos](#)
- [Copy Photos from Media Over a Local Connection](#)

## Before Copying Photos

### IMPORTANT

DO NOT start your computer with a memory card or USB flash drive in the media drive of the machine. You could lose your data or damage the media.



- The machine will read only the media that was put in first.
- While the machine is printing photos from the media, your computer cannot access the photo printing for any other operation.



### Related Information

- [Copy Photos from Media to a Computer](#)

## Copy Photos from Media Over a Local Connection

You can copy photos from media to your computer when it is locally connected (via USB) to your machine.

1. Insert a memory card or USB flash drive into your machine.
2. Do one of the following:
  - (Windows)  
In Windows Explorer, double-click the **Removable Disk** icon.
  - (Mac)  
Double-click the removable disk icon.



If you create a name for the volume label of the media, this name appears.

The files and folders on the media appear on your computer screen.

3. You can edit a file and save it to another drive on your computer.
4. Quit all applications that are running stored data on the media.
5. Do one of the following:
  - (Windows)  
In Windows Explorer, right-click the removable disk icon and select **Eject**.
  - (Mac)  
Drag the removable disk icon into the **Trash** icon.
6. Wait until your Brother machine has stopped accessing the media before removing the media.

### IMPORTANT

DO NOT remove the media while your Brother machine is accessing the media. Otherwise, the media, or data stored on the media could be damaged.

If you remove the media while your Brother machine is accessing the media, you must restart your computer before inserting the same media into the machine. If you do not restart your computer, the data on your media could be destroyed.



### Related Information

- [Copy Photos from Media to a Computer](#)

## Print Photos from ControlCenter4 (Windows)

You can print and edit photos using various ControlCenter features.

1. Make sure you have loaded the correct media in the paper tray.

### IMPORTANT

- For best results, use Brother paper.
- When you print on Brother photo paper, load one extra sheet of the same photo paper in the paper tray.

2. Click the  (ControlCenter4) icon in the task tray, and then click **Open**.
3. Do one of the following:
  - If you are using **Advanced Mode**, click the **Photo** tab, and then click the **Photo Print** button.
  - If you are using **Home Mode**, click the **Photo** tab.



4. Select the folder that contains the image you want to print.

Option	Description
<b>My CC4 Folder</b>	The My CC4 Folder button lets you open the ControlCenter4 folder located in the My Pictures folder on your computer.
<b>Desktop</b>	The Desktop button lets you open the folder tree from your desktop to select images you want to print.

5. Select images you want to print, by selecting the check box under the thumbnail in the image viewer.

Option	Description
<b>Select All</b>	Selects all thumbnails in the current view.

Option	Description
--------	-------------

<b>Deselect All</b>	Deselects all thumbnails in the current view.
---------------------	---

- Specify the number of copies you want to print (1-99) by clicking .
- To trim the photo before printing, click **Edit**.
- Click **Print**.  
The print settings window appears.
- Configure the settings for the **Paper Size**, **Media Type**, and **Layout** options.

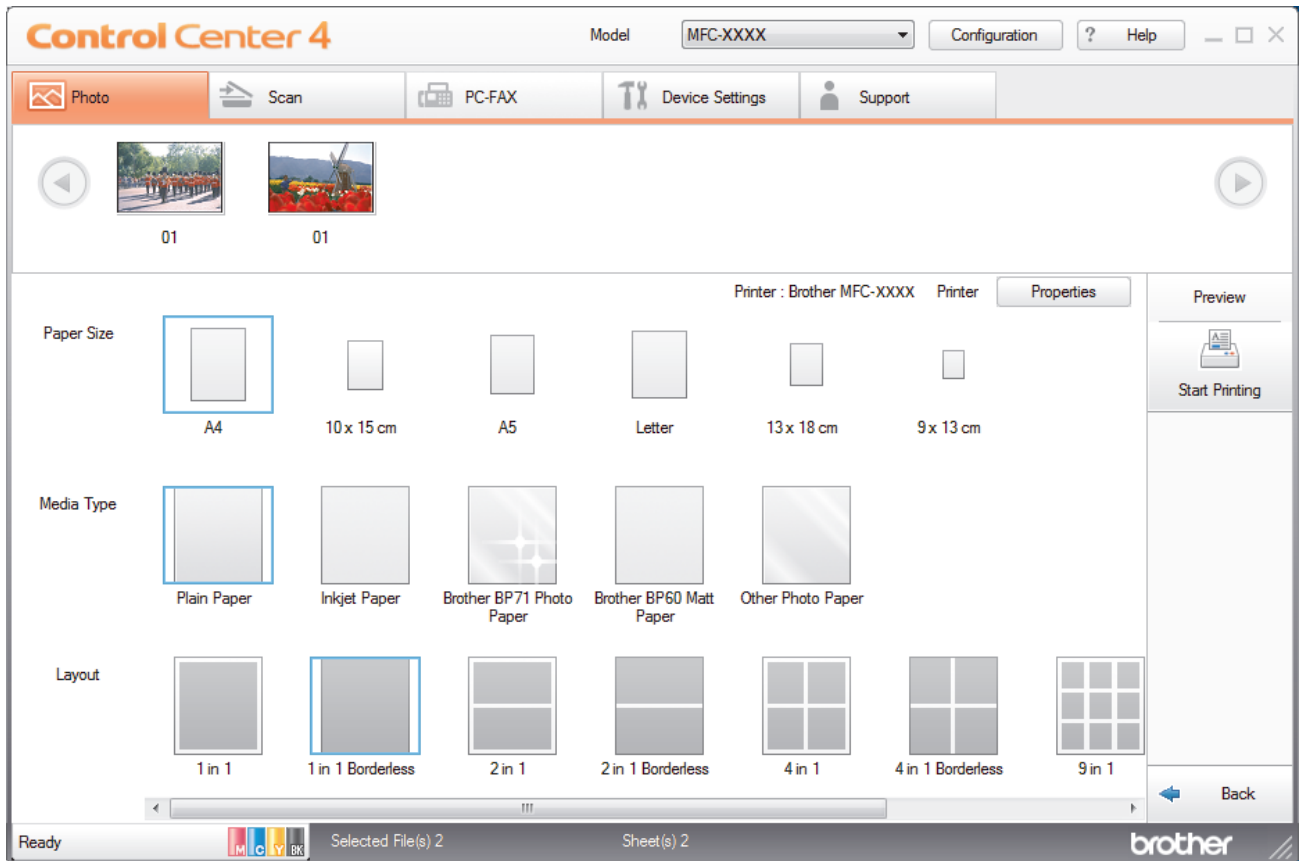

- Click the **Properties** button to configure the **Print Quality**, **Colour / Greyscale** and **Colour Mode** options, if needed. To print the image's timestamp in the lower-right corner of the image, select the **Print Date** check box.
- To change other printer settings, click the **Print Options...** button. (For Advanced Mode only)
- Click **OK**.
- Click the **Preview** button to view the image on screen before printing.
- Click the **Start Printing** button.

### Related Information

- [PhotoCapture Center](#)
  - [Edit Photos Using ControlCenter4 \(Windows\)](#)



## Edit Photos Using ControlCenter4 (Windows)

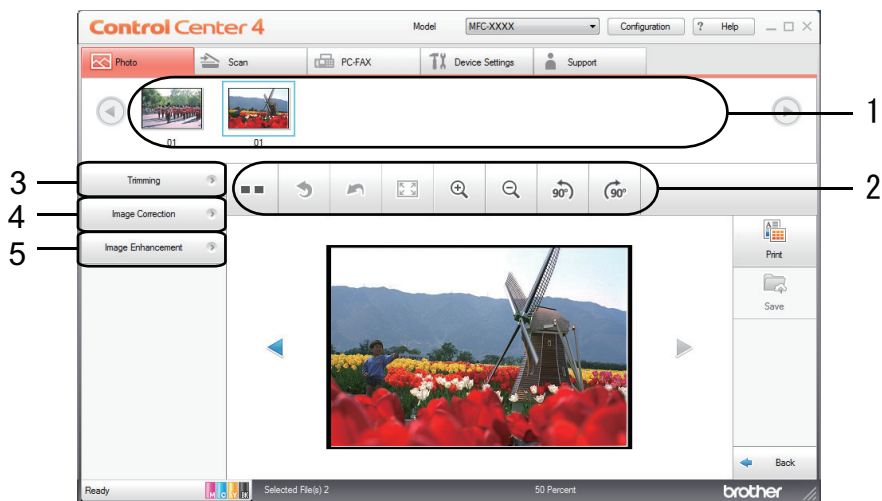

1. This area shows which images are currently selected, and how many copies of each image will be printed.
2. These buttons allow you to control how you view the selected image.

Buttons	Description
(Compare)	Compare the edited image with the original.
(Undo)	Cancel the last edit applied to the selected image.
(Restart)	Cancel all the edits applied to the selected image. The edited image reverts to its original state.
(Fit to Window)	Set the zoom level so that the image fits the window.
(Zoom In/Zoom Out)	Enlarge or reduce the selected image.
(Rotate Counterclockwise/Rotate Clockwise)	Rotate the image by 90 degrees, clockwise or counterclockwise.
(Previous/Next)	Display the previous or next image.

### 3. Trimming

This feature allows you to remove unwanted areas from your photos.

### 4. Image Correction

#### Auto Correction

Select this option to apply a range of automatic corrections that can enhance an image.

#### Red-Eye Removal

Select this option to correct red eye in photo images, which is sometimes caused by a camera's flash.

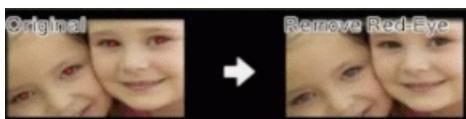

#### Monochrome

Select this option to remove colour information from the image.

#### Sepia

Select this option to remove colour information from the image and add a sepia tone.

---

## 5. Image Enhancement

### Nature Scene

Select this option to enhance natural colours, such as green and blue.

### Night Scene

Select this option to optimise the image adjustments for a night scene photo.

### Soft Light

Select this option to soften bright edges.



## Related Information

---

- [Print Photos from ControlCenter4 \(Windows\)](#)
-

## Network

- [Configure Network Details Using the Control Panel](#)
- [Supported Basic Network Features](#)
- [Network Management Software and Utilities](#)
- [Additional Methods of Configuring Your Brother Machine for a Wireless Network](#)
- [Advanced Network Features](#)
- [Technical Information for Advanced Users](#)

## Configure Network Details Using the Control Panel

To configure the machine to your network, use the control panel's [Network] menu selections.



- For information about the network settings you can configure using the control panel, see *Related Information: Settings Tables*.
- You can also use management utilities, such as BRAdmin Light (Windows), BRAdmin Professional (Windows) and Web Based Management, to configure and change your Brother machine's network settings.

See *Related Information: Learn about Network Management Software and Utilities*.

1. Press  [Settings] > [All Settings] > [Network].
2. Press ▲ or ▼ to display the network option, and then press it. Repeat this step until you access the menu you want to configure, and then follow the touchscreen LCD instructions.



### Related Information

- [Network](#)

#### Related Topics:

- [Settings Tables \(2.7"\(67.5 mm\) Touchscreen models\)](#)
- [Learn about Network Management Software and Utilities](#)

## Supported Basic Network Features

The print server supports various features depending on the operating system. Use this table to see which network features and connections are supported by each operating system.

Operating Systems	Windows 7 Windows 8 Windows 10	Windows Server 2008/2012/2012 R2/2016	macOS
Printing	Yes	Yes	Yes
Scanning	Yes		Yes
PC Fax Send (Available only for certain models) <sup>1</sup>	Yes		Yes
PC Fax Receive (Available only for certain models) <sup>1</sup>	Yes		
BRAdmin Light <sup>2 4</sup>	Yes	Yes	
BRAdmin Professional <sup>4 3</sup>	Yes	Yes	
Web Based Management <sup>4</sup>	Yes	Yes	Yes
Remote Setup (Available only for certain models) <sup>1</sup>	Yes		
Status Monitor	Yes		Yes
Driver Deployment Wizard	Yes	Yes	

### ✓ Related Information

- [Network](#)

<sup>1</sup> Not available for DCP models.

<sup>2</sup> BRAdmin Light is available as a download from your model's page at [support.brother.com](http://support.brother.com).

<sup>3</sup> BRAdmin Professional is available as a download from your model's page at [support.brother.com](http://support.brother.com).

<sup>4</sup> The default login password to manage machine settings is **initpass**. We recommend you change it to protect your machine from unauthorised access.

## Network Management Software and Utilities

Configure and change your Brother machine's network settings using a management utility.

- [Learn about Network Management Software and Utilities](#)
- [Change Machine Settings from Your Computer](#)

## Learn about Network Management Software and Utilities

### Web Based Management

Web Based Management is a utility that uses a standard web browser to manage your machine using the Hyper Text Transfer Protocol (HTTP) or Hyper Text Transfer Protocol over Secure Socket Layer (HTTPS). Type your machine's IP address into your web browser to access and change your print server settings.

### BRAdmin Light (Windows)

BRAdmin Light is a utility for the initial setup of Brother network-connected devices. This utility can search for Brother products on your network, view the status and configure the basic network settings, such as IP address.

Go to your model's **Downloads** page on the Brother Solutions Center at [support.brother.com](http://support.brother.com) to download BRAdmin Light.



- If using Windows Firewall, or the firewall function of an anti-spyware or antivirus application, temporarily disable them. When you are sure you can print, configure the software settings following the instructions.

### BRAdmin Professional (Windows)

BRAdmin Professional is a utility for more advanced management of network-connected Brother devices. This utility can search for Brother products on your network and view the device status from an easy-to-read Windows Explorer-style screen that changes colour to identify the status of each device. You can configure network and device settings, and update device firmware from a Windows computer on your LAN. BRAdmin Professional can also log activity of Brother devices on your network and export the log data.



- Go to your model's **Downloads** page on the Brother Solutions Center at [support.brother.com](http://support.brother.com) to download the latest version of Brother's **BRAdmin Professional** utility.
- Node name: The node name appears in the current BRAdmin Professional window. The default node name is "BRNxxxxxxxxxxxx" for a wired network or "BRWxxxxxxxxxxxx" for a wireless network (where "xxxxxxxxxxxx" is your machine's MAC Address / Ethernet address).
- If using Windows Firewall, or the firewall function of an anti-spyware or antivirus application, temporarily disable them. When you are sure you can print, configure the software settings following the instructions.

### Remote Setup (Windows and Mac) (MFC-J1300DW)

Remote Setup is a program for configuring many machine and network settings from either a Windows or a Mac application. When you start this application, the settings on your machine are automatically downloaded to your computer and displayed on your computer screen. If you change the settings, you can upload them directly to the machine.



#### Windows

This utility can be used with either a USB or a network connection.

#### Mac

- Go to your model's **Downloads** page on the Brother Solutions Center at [support.brother.com](http://support.brother.com) to download the Remote Setup.
- This utility can be used with a USB connection.



### Related Information

- [Network Management Software and Utilities](#)

#### Related Topics:

- [Change Machine Settings Using Web Based Management](#)

## Additional Methods of Configuring Your Brother Machine for a Wireless Network

To connect your machine to your wireless network, we recommend using the Brother installation disc.

- [Before Configuring Your Brother Machine for a Wireless Network](#)
- [Configure Your Machine for a Wireless Network Using the One Push Method of Wi-Fi Protected Setup™ \(WPS\)](#)
- [Configure Your Machine for a Wireless Network Using the PIN Method of Wi-Fi Protected Setup™ \(WPS\)](#)
- [Configure Your Machine for a Wireless Network When the SSID is Not Broadcast](#)
- [Configure Your Machine for an Enterprise Wireless Network](#)
- [Use Wi-Fi Direct®](#)



## Before Configuring Your Brother Machine for a Wireless Network

Before attempting to configure a wireless network, confirm the following:

- If you are using an enterprise wireless network, you must know the User ID and Password.
- To achieve optimum results with normal everyday document printing, place the Brother machine as close to the wireless LAN access point/router as possible with minimal obstructions. Large objects and walls between the two devices and interference from other electronic devices can affect the data transfer speed of your documents.

Due to these factors, wireless may not be the best method of connection for all types of documents and applications. If you are printing large files, such as multi-page documents with mixed text and large graphics, you may want to consider selecting wired Ethernet for faster data transfer (supported models only), or USB for the fastest throughput speed.

- Although the Brother machine can be used in both a wired and wireless network (supported models only), only one connection method can be used at a time. However, a wireless network connection and Wi-Fi Direct connection, or a wired network connection (supported models only) and Wi-Fi Direct connection can be used at the same time.



If you do not know the security information (for example, Network Name (SSID) and Network Key), consult the router manufacturer, your system administrator, or your Internet provider.



### Related Information

- [Additional Methods of Configuring Your Brother Machine for a Wireless Network](#)

## Configure Your Machine for a Wireless Network Using the One Push Method of Wi-Fi Protected Setup™ (WPS)

If your wireless access point/router supports WPS (Push Button Configuration), you can use WPS from your machine's control panel menu to configure your wireless network settings.



Routers or access points that support WPS are marked with this symbol:



1. Press  [Settings] > [All Settings] > [Network] > [WLAN] > [WPS].
2. When [Enable WLAN?] appears, press [Yes].  
The wireless setup wizard starts. To cancel, press [No].
3. When the touchscreen instructs you to start WPS, press the WPS button on your wireless access point/router. Then press [OK] on your machine. Your machine automatically tries to connect to your wireless network.

If your wireless device is connected successfully, the LCD displays [Connected].

You have completed the wireless network setup. To install the **Full Driver & Software Package** necessary for operating your machine, insert the Brother installation disc into your computer, or go to your model's **Downloads** page on the Brother Solutions Center at [support.brother.com](http://support.brother.com).



### Related Information

- [Additional Methods of Configuring Your Brother Machine for a Wireless Network](#)

## Configure Your Machine for a Wireless Network Using the PIN Method of Wi-Fi Protected Setup™ (WPS)

If your wireless LAN access point/router supports WPS, you can use the Personal Identification Number (PIN) Method to configure your wireless network settings.

The PIN Method is one of the connection methods developed by the Wi-Fi Alliance®. By submitting a PIN created by an Enrollee (your machine) to the Registrar (a device that manages the wireless LAN), you can set up the wireless network and security settings. For more information on how to access WPS mode, see the instructions provided with your wireless access point/router.

### Type A

Connection when the wireless LAN access point/router (1) doubles as the Registrar.

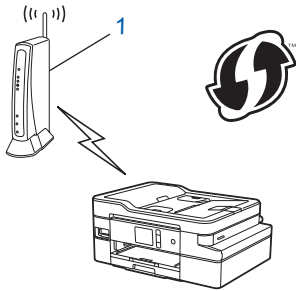

### Type B

Connection when another device (2), such as a computer, is used as the Registrar.

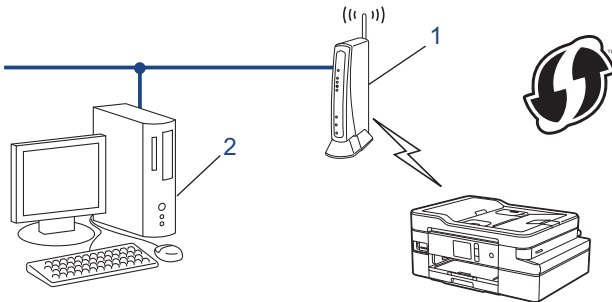

 Routers or access points that support WPS are marked with this symbol:



1. Press  [Settings] > [All Settings] > [Network] > [WLAN] > [WPS w/ PIN Code].
2. When [Enable WLAN?] appears, press [Yes].  
The wireless setup wizard starts. To cancel, press [No].
3. The LCD displays an eight-digit PIN and the machine starts searching for a wireless LAN access point/router.
4. Using a computer connected to the network, in your browser's address bar, type the IP address of the device you are using as the Registrar. (For example: <http://192.168.1.2>)
5. Go to the WPS settings page and type the PIN, and then follow the on-screen instructions.



- The Registrar is usually the wireless LAN access point/router.
- The settings page will differ depending on the brand of wireless LAN access point/router. For more information, see the instructions supplied with your wireless LAN access point/router.

**If you are using a Windows 7, Windows 8, or Windows 10 computer as a Registrar, complete the following steps:**

6. Do one of the following:

- Windows 7

Click  (**Start**) > **Devices and Printers** > **Add a device**.

- Windows 8

Move your mouse to the lower right corner of your desktop. When the menu bar appears, click **Settings** > **Control Panel** > **Hardware and Sound** > **Devices and Printers** > **Add a device**.

- Windows 10

Click  > **Windows System** > **Control Panel**. In the **Hardware and Sound** group, click **Add a device**.



- To use a Windows 7, Windows 8, or Windows 10 computer as a Registrar, you must register it to your network in advance. For more information, see the instructions supplied with your wireless LAN access point/router.
- If you use Windows 7, Windows 8, or Windows 10 as a Registrar, you can install the printer driver after the wireless configuration by following the on-screen instructions. To install the **Full Driver & Software Package** necessary for operating your machine, insert the Brother installation disc into your computer or go to your model's **Downloads** page on the Brother Solutions Center at [support.brother.com](http://support.brother.com).

7. Select your machine and click **Next**.

8. Type the PIN displayed on the machine's LCD, and then click **Next**.

9. (Windows 7) Select your network, and then click **Next**.

10. Click **Close**.



## Related Information

- [Additional Methods of Configuring Your Brother Machine for a Wireless Network](#)

## Configure Your Machine for a Wireless Network When the SSID is Not Broadcast

Before configuring your machine, we recommend writing down your wireless network settings. You will need this information before you continue with the configuration.

1. Check and write down the current wireless network settings.

Network Name (SSID)				
Communication Mode	Authentication Method	Encryption Mode	Network Key	
Infrastructure	Open System	NONE	-	
		WEP		
	Shared Key	WEP		
		WPA/WPA2-PSK	AES	
			TKIP	

For example:

Network Name (SSID)			
HELLO			
Communication Mode	Authentication Method	Encryption Mode	Network Key
Infrastructure	WPA2-PSK	AES	12345678



If your router uses WEP encryption, enter the key used as the first WEP key. Your Brother machine supports the use of the first WEP key only.

2. Press  [Settings] > [All Settings] > [Network] > [WLAN] > [Setup Wizard].
3. When [Enable WLAN?] appears, press [Yes].  
The wireless setup wizard starts. To cancel, press [No].
4. The machine searches for your network and displays a list of available SSIDs. Press ▲ or ▼ to display the [<New SSID>] option, and then press it.
5. Press [OK].
6. Enter the SSID name, and then press [OK].



For more information about how to enter text, see the *Appendix*.

7. Press [Infrastructure].
8. Select the Authentication Method, and then press it.
9. Do one of the following:
  - If you selected the [Open System] option, press either [None] or [WEP].  
If you selected the [WEP] option for Encryption type, enter the WEP key, and then press [OK].
  - If you selected the [Shared Key] option, enter the WEP key, and then press [OK].
  - If you selected the [WPA/WPA2-PSK] option, press either [TKIP+AES] or [AES].  
Enter the WPA key, and then press [OK].



- For more information about how to enter text, see the *Appendix*.
- Your Brother machine supports the use of the first WEP key only.

10. The machine attempts to connect to the wireless device you have selected.

If your wireless device is connected successfully, the LCD displays [Connected].

You have completed the wireless network setup. To install the **Full Driver & Software Package** necessary for operating your machine, insert the Brother installation disc into your computer, or go to your model's **Downloads** page on the Brother Solutions Center at [support.brother.com](http://support.brother.com).



### Related Information

- [Additional Methods of Configuring Your Brother Machine for a Wireless Network](#)

#### Related Topics:

- [I Cannot Complete the Wireless Network Setup Configuration](#)
-

## Configure Your Machine for an Enterprise Wireless Network

Before configuring your machine, we recommend writing down your wireless network settings. You will need this information before you continue with the configuration.

1. Check and record the current wireless network settings.

Network Name (SSID)

Communication Mode	Authentication Method	Encryption Mode	User ID	Password
Infrastructure	LEAP	CKIP		
		AES		
	EAP-FAST/NONE	TKIP		
		AES		
	EAP-FAST/MS-CHAPv2	TKIP		
		AES		
	EAP-FAST/GTC	TKIP		
		AES		
	PEAP/MS-CHAPv2	TKIP		
		AES		
	PEAP/GTC	TKIP		
		AES		
	EAP-TTLS/CHAP	TKIP		
		AES		
	EAP-TTLS/MS-CHAP	TKIP		
		AES		
	EAP-TTLS/MS-CHAPv2	TKIP		
		AES		
EAP-TTLS/PAP	TKIP			
	AES			
EAP-TLS	TKIP			-
	AES			-

For example:

Network Name (SSID)
HELLO

Communication Mode	Authentication Method	Encryption Mode	User ID	Password
Infrastructure	EAP-FAST/MS-CHAPv2	AES	Brother	12345678



- If you configure your machine using EAP-TLS authentication, you must install the client certificate issued by a CA before you start configuration. Contact your network administrator about the client certificate. If you have installed more than one certificate, we recommend writing down the certificate name you want to use.
- If you verify your machine using the common name of the server certificate, we recommend writing down the common name before you start configuration. Contact your network administrator about the common name of the server certificate.

2. Press  [Settings] > [All Settings] > [Network] > [WLAN] > [Setup Wizard].
3. When [Enable WLAN?] appears, press [Yes].  
The wireless setup wizard starts. To cancel, press [No].
4. The machine searches for your network and displays a list of available SSIDs. Press ▲ or ▼ to display the [<New SSID>] option, and then press it.
5. Press [OK].
6. Enter the SSID name, and then press [OK].



For more information about how to enter text, see the *Appendix*.

7. Press [Infrastructure].
8. Select the Authentication Method, and then press it.
9. Do one of the following:
  - If you selected the [LEAP] option, enter the user ID, and then press [OK]. Enter the Password, and then press [OK].
  - If you selected the [EAP-FAST], [PEAP] or [EAP-TTLS] option, select the Inner Authentication method [NONE], [CHAP], [MS-CHAP], [MS-CHAPv2], [GTC] or [PAP].



Depending on your Authentication method, the Inner Authentication method selections differ.

Select the encryption type [TKIP+AES] or [AES].

Select the verification method [No Verification], [CA] or [CA + Server ID].

- If you selected the [CA + Server ID] option, enter the server ID, user ID and password (if required), and then press [OK] for each option.
- For other selections, enter the user ID and Password, and then press [OK] for each option.



If you have not imported a CA certificate into your machine, the machine displays [No Verification].

- If you selected the [EAP-TLS] option, select the encryption type [TKIP+AES] or [AES].  
The machine will display a list of available Client Certificates, and then select the certificate.  
Select the verification method [No Verification], [CA] or [CA + Server ID].
  - If you selected the [CA + Server ID] option, enter the server ID and user ID, and then press [OK] for each option.
  - For other selections, enter the user ID, and then press [OK].

10. The machine attempts to connect to the wireless device you have selected.

If your wireless device is connected successfully, the LCD displays [Connected].

You have completed the wireless network setup. To install **Full Driver & Software Package** necessary for operating your device, insert the Brother installation disc into your computer or go to your model's **Downloads** page on the Brother Solutions Center at [support.brother.com](http://support.brother.com).



## Related Information

- [Additional Methods of Configuring Your Brother Machine for a Wireless Network](#)



## Use Wi-Fi Direct®

- [Print or Scan from Your Mobile Device Using Wi-Fi Direct](#)
- [Configure Your Wi-Fi Direct Network](#)
- [I Cannot Complete the Wireless Network Setup Configuration](#)

## Print or Scan from Your Mobile Device Using Wi-Fi Direct

Wi-Fi Direct is one of the wireless configuration methods developed by the Wi-Fi Alliance®. It allows you to configure a secured wireless network between your Brother machine and a mobile device, such as an Android™ device, Windows device, iPhone, iPod touch, or iPad, without using an access point. Wi-Fi Direct supports wireless network configuration using the one-push or PIN Method of Wi-Fi Protected Setup™ (WPS). You can also configure a wireless network by manually setting a SSID and password. Your Brother machine's Wi-Fi Direct feature supports WPA2™ security with AES encryption.



1. Mobile device
2. Your Brother machine



- Although the Brother machine can be used in both a wired (supported models only) and wireless network, only one connection method can be used at a time. However, a wireless network connection and Wi-Fi Direct connection, or a wired network connection and Wi-Fi Direct connection can be used at the same time.
- The Wi-Fi Direct supported device can become a Group Owner (G/O). When configuring the Wi-Fi Direct network, the Group Owner (G/O) serves as an access point.



### Related Information

- [Use Wi-Fi Direct®](#)

## Configure Your Wi-Fi Direct Network

Configure your Wi-Fi Direct network settings from your machine's control panel.

- [Wi-Fi Direct Network Configuration Overview](#)
- [Configure Your Wi-Fi Direct Network Using the One-Push Method](#)
- [Configure Your Wi-Fi Direct Network Using the One-Push Method of Wi-Fi Protected Setup™ \(WPS\)](#)
- [Configure Your Wi-Fi Direct Network Using the PIN Method](#)
- [Configure Your Wi-Fi Direct Network Using the PIN Method of Wi-Fi Protected Setup™ \(WPS\)](#)
- [Configure Your Wi-Fi Direct Network Manually](#)

## Wi-Fi Direct Network Configuration Overview

The following instructions offer five methods for configuring your Brother machine in a wireless network environment. Select the method you prefer for your environment.

Check your mobile device for configuration.

1. Does your mobile device support Wi-Fi Direct?

Option	Description
Yes	Go to Step 2
No	Go to Step 3

2. Does your mobile device support one-push configuration for Wi-Fi Direct?

Option	Description
Yes	See <i>Related Information</i> : Configure Your Wi-Fi Direct Network Using the One-Push Method
No	See <i>Related Information</i> : Configure Your Wi-Fi Direct Network Using the PIN Method

3. Does your mobile device support Wi-Fi Protected Setup™ (WPS)?

Option	Description
Yes	Go to Step 4
No	See <i>Related Information</i> : Configure Your Wi-Fi Direct Network Manually

4. Does your mobile device support one-push configuration for Wi-Fi Protected Setup™ (WPS)?

Option	Description
Yes	See <i>Related Information</i> : Configure Your Wi-Fi Direct Network Using the One-Push Method of Wi-Fi Protected Setup™ (WPS)
No	See <i>Related Information</i> : Configure Your Wi-Fi Direct Network Using the PIN Method of Wi-Fi Protected Setup™ (WPS)

To use Brother iPrint&Scan functionality in a Wi-Fi Direct network configured by one-push configuration using Wi-Fi Direct or by PIN Method configuration using Wi-Fi Direct, the device you use to configure Wi-Fi Direct must be running Android™ 4.0 or greater.

### ✓ Related Information

- [Configure Your Wi-Fi Direct Network](#)

#### Related Topics:

- [Configure Your Wi-Fi Direct Network Using the One-Push Method](#)
- [Configure Your Wi-Fi Direct Network Using the PIN Method](#)
- [Configure Your Wi-Fi Direct Network Manually](#)
- [Configure Your Wi-Fi Direct Network Using the One-Push Method of Wi-Fi Protected Setup™ \(WPS\)](#)
- [Configure Your Wi-Fi Direct Network Using the PIN Method of Wi-Fi Protected Setup™ \(WPS\)](#)

## Configure Your Wi-Fi Direct Network Using the One-Push Method

If your mobile device supports Wi-Fi Direct, follow these steps to configure a Wi-Fi Direct network:



When the machine receives the Wi-Fi Direct request from your mobile device, the message [Wi-Fi Direct connection request received. Press [OK] to connect.] will appear on the LCD. Press [OK] to connect.

1. Press  [Settings] > [All Settings] > [Network] > [Wi-Fi Direct] > [Push Button].
2. Activate Wi-Fi Direct on your mobile device (see your mobile device's user's guide for instructions) when [Activate Wi-Fi Direct on other device. Then Press [OK].] appears. Press [OK] on your Brother machine.  
This will start the Wi-Fi Direct setup.
3. Do one of the following:
  - When your Brother machine is the Group Owner (G/O), connect your mobile device to the machine directly.
  - When your Brother machine is not the Group Owner (G/O), it will display available device names with which to configure a Wi-Fi Direct network. Select the mobile device to which you want to connect. Search for available devices again by pressing [Rescan].

If your mobile device connects successfully, the machine displays [Connected]. You have completed the Wi-Fi Direct network setup.



### Related Information

- [Configure Your Wi-Fi Direct Network](#)

#### Related Topics:

- [Wi-Fi Direct Network Configuration Overview](#)

## Configure Your Wi-Fi Direct Network Using the One-Push Method of Wi-Fi Protected Setup™ (WPS)

If your mobile device supports WPS (PBC; Push Button Configuration), follow these steps to configure a Wi-Fi Direct network:



When the machine receives the Wi-Fi Direct request from your mobile device, the message [Wi-Fi Direct connection request received. Press [OK] to connect.] will appear on the LCD. Press [OK] to connect.

1. Press  [Settings] > [All Settings] > [Network] > [Wi-Fi Direct] > [Group Owner] > [On].
2. Press [Push Button].
3. Activate your mobile device's WPS one-push configuration method (see your mobile device's user's guide for instructions). When [Activate Wi-Fi Direct on other device. Then Press [OK].] appears on the machine's LCD, press [OK] on your machine.

This will start the Wi-Fi Direct setup.

If your mobile device connects successfully, the machine displays [Connected]. You have completed the Wi-Fi Direct network setup.



### Related Information

- [Configure Your Wi-Fi Direct Network](#)

#### Related Topics:

- [Wi-Fi Direct Network Configuration Overview](#)

## Configure Your Wi-Fi Direct Network Using the PIN Method

If your mobile device supports the PIN Method of Wi-Fi Direct, follow these steps to configure a Wi-Fi Direct network:



When the machine receives the Wi-Fi Direct request from your mobile device, the message [Wi-Fi Direct connection request received. Press [OK] to connect.] will appear on the LCD. Press [OK] to connect.

1. Press  [Settings] > [All Settings] > [Network] > [Wi-Fi Direct] > [PIN Code].
2. Activate Wi-Fi Direct on your mobile device (see your mobile device's user's guide for instructions) when [Activate Wi-Fi Direct on other device. Then Press [OK].] appears. Press [OK] on your Brother machine.  
This will start the Wi-Fi Direct setup.
3. Do one of the following:
  - When your Brother machine is the Group Owner (G/O), it will wait for a connection request from your mobile device. When [PIN Code] appears, enter the PIN displayed on your mobile device in the machine. Press [OK]. Follow the instructions.  
If the PIN is displayed on your Brother machine, enter the PIN in your mobile device.
  - When your Brother machine is not the Group Owner (G/O), it will display available device names with which to configure a Wi-Fi Direct network. Select the mobile device to which you want to connect. Search for available devices again by pressing [Rescan].  
Do one of the following:
    - Press [Display PIN Code] to display the PIN on your machine and enter the PIN in your mobile device. Follow the instructions.
    - Press [Input PIN Code] to enter a PIN shown on your mobile device in the machine, and then press [OK]. Follow the instructions.

If your mobile device does not display a PIN, press  on your Brother machine. Go back to step 1 and try again.

If your mobile device connects successfully, the machine displays [Connected]. You have completed the Wi-Fi Direct network setup.



### Related Information

- [Configure Your Wi-Fi Direct Network](#)

#### Related Topics:

- [Wi-Fi Direct Network Configuration Overview](#)

## Configure Your Wi-Fi Direct Network Using the PIN Method of Wi-Fi Protected Setup™ (WPS)

If your mobile device supports the PIN Method of Wi-Fi Protected Setup™ (WPS), follow these steps to configure a Wi-Fi Direct network:



When the machine receives the Wi-Fi Direct request from your mobile device, the message [Wi-Fi Direct connection request received. Press [OK] to connect.] will appear on the LCD. Press [OK] to connect.

1. Press  [Settings] > [All Settings] > [Network] > [Wi-Fi Direct] > [Group Owner] > [On] > [PIN Code].
2. When [Activate Wi-Fi Direct on other device. Then Press [OK].] is displayed, activate your mobile device's WPS PIN configuration method (see your mobile device's user's guide for instructions), and then press [OK] on your Brother machine.  
This will start the Wi-Fi Direct setup.
3. The machine will wait for a connection request from your mobile device. When [PIN Code] appears, enter the PIN displayed on your mobile device in the machine. Press [OK].

If your mobile device connects successfully, the machine displays [Connected]. You have completed the Wi-Fi Direct network setup.



### Related Information

- [Configure Your Wi-Fi Direct Network](#)

#### Related Topics:

- [Wi-Fi Direct Network Configuration Overview](#)



## Configure Your Wi-Fi Direct Network Manually

If your mobile device does not support Wi-Fi Direct or WPS, you must configure a Wi-Fi Direct network manually.

1. Press  [Settings] > [All Settings] > [Network] > [Wi-Fi Direct] > [Manual].
2. The machine will display the SSID name and Password. Go to your mobile device's wireless network settings screen, select the SSID name, and then enter the password.

If your mobile device connects successfully, the machine displays [Connected]. You have completed the Wi-Fi Direct network setup.



### Related Information

- [Configure Your Wi-Fi Direct Network](#)

#### Related Topics:

- [Wi-Fi Direct Network Configuration Overview](#)

## Advanced Network Features

- [Print the Network Configuration Report](#)
- [Configure and Operate LDAP Search](#)
- [Synchronize Time with the SNTP Server Using Web Based Management](#)

## Print the Network Configuration Report

The Network Configuration Report lists the network configuration, including the network print server settings.



- **Node Name:** The Node Name appears on the current Network Configuration Report. The default Node Name is "BRNxxxxxxxxxxx" for a wired network or "BRWxxxxxxxxxxx" for a wireless network (where "xxxxxxxxxxx" is your machine's MAC Address / Ethernet Address.)
- If the [IP Address] on the Network Configuration Report shows 0.0.0.0, wait for one minute and try printing it again.
- You can find your machine's settings, such as the IP address, subnet mask, node name, and MAC Address on the report, for example:
  - IP address: 192.168.0.5
  - Subnet mask: 255.255.255.0
  - Node name: BRN000ca0000499
  - MAC Address: 00-0c-a0-00-04-99

1. Press  [Settings] > [All Settings] > [Print Reports] > [Network Configuration] > [Yes].

The machine prints the current Network Configuration Report.



### Related Information

- [Advanced Network Features](#)

#### Related Topics:

- [Access Web Based Management](#)
- [Where Can I Find My Brother Machine's Network Settings?](#)
- [Use the Network Connection Repair Tool \(Windows\)](#)
- [I Want to Check that My Network Devices are Working Correctly](#)
- [Configure IEEE 802.1x Authentication for a Wired or a Wireless Network Using Web Based Management \(Web Browser\)](#)
- [Error and Maintenance Messages](#)

## Configure and Operate LDAP Search

**Related Models:** MFC-J1300DW

The LDAP feature allows you to search for information, such as fax numbers and email addresses, on your server. When you use the Fax feature, you can use the LDAP search to find fax numbers or email addresses.



- The LDAP feature does not support simplified Chinese, traditional Chinese, or Korean.
- The LDAP feature supports LDAPv3.
- The LDAP feature does not support SSL/TLS.
- You must use Simple Authentication to communicate with your LDAP server.



### Related Information

- [Advanced Network Features](#)
  - [Change LDAP Configuration Using Web Based Management](#)
  - [Perform an LDAP Search Using Your Machine's Control Panel](#)

## Change LDAP Configuration Using Web Based Management

Related Models: MFC-J1300DW

Use Web Based Management to configure your LDAP settings in a web browser.

1. Start your web browser.
2. Type "https://machine's IP address" in your browser's address bar (where "machine's IP address" is the machine's IP address).  
For example:  
https://192.168.1.2
3. If the machine prompts you for a password, type it, and then click .
4. Click the **Network** tab.
5. Click the **Protocol** menu in the left navigation bar.
6. Select the **LDAP** check box, and then click **Submit**.
7. Restart your Brother machine to activate the configuration.
8. On your computer, in Web Based Management's **Address Book** tab, select **LDAP** in the left navigation bar.
  - **LDAP Search**
  - **LDAP Server Address**
  - **Port** (The default port number is 389.)
  - **Search Root**
  - **Authentication**
  - **Username**  
This selection will be available depending on the authentication method used.
  - **Password**  
This selection will be available depending on the authentication method used.



- If the LDAP server supports Kerberos authentication, we recommend selecting Kerberos for the Authentication settings. It provides strong authentication between the LDAP server and your machine.
- You must configure the SNTP protocol (network time server), or you must set the date, time and time zone correctly on the control panel for Kerberos authentication.

- **Kerberos Server Address**  
This selection will be available depending on the authentication method used.
  - **Timeout for LDAP**
  - **Attribute of Name (Search Key)**
  - **Attribute of E-mail**
  - **Attribute of Fax Number**
9. When finished, click **Submit**. Make sure the **Status** field reads **OK**.



### Related Information

- [Configure and Operate LDAP Search](#)

#### Related Topics:

- [Synchronize Time with the SNTP Server Using Web Based Management](#)

## Perform an LDAP Search Using Your Machine's Control Panel

**Related Models:** MFC-J1300DW

After you configure LDAP settings, you can use the LDAP search feature to find fax numbers to use for:

- Sending a Fax (not available for DCP models)



- The LDAP feature supports LDAPv3.
- The LDAP feature does not support SSL/TLS.
- You may need to use Kerberos Authentication or Simple Authentication to connect to your LDAP server, depending on the security policy set by your network administrator.
- You must configure the SNTP protocol (network time server), or you must set the date, time and time zone correctly on the control panel for Kerberos authentication.

1. Press  to search.
2. Enter the initial characters for your search using the LCD.



- You can enter up to 15 characters.
- For more information about how to enter text, see the *Appendix*.

3. Press [OK].

The LDAP search result will be shown on the LCD; the  icon appears before the local address book search results.

- If there is no match on the server or the local address book, the LCD will show [Results cannot be found.] for about 60 seconds.
4. Press ▲ or ▼ to display the name you want.
  5. Press the name.  
To view the details of the name, press [Detail].
  6. If the result includes more than one fax number, the machine will prompt you to select just one. Press [Apply], and then [Fax Start].



### Related Information

- [Configure and Operate LDAP Search](#)

#### Related Topics:

- [Synchronize Time with the SNTP Server Using Web Based Management](#)

## **Synchronize Time with the SNTP Server Using Web Based Management**

The Simple Network Time Protocol (SNTP) is used to synchronize the time used by the machine for authentication with the SNTP time server. (This is not the time displayed on the machine's LCD.) You can automatically or manually synchronize the machine's time with the Coordinated Universal Time (UTC) provided by the SNTP time server.

- [Configure Date and Time Using Web Based Management](#)
- [Configure the SNTP Protocol Using Web Based Management](#)
- [Change LDAP Configuration Using Web Based Management](#)
- [Perform an LDAP Search Using Your Machine's Control Panel](#)

## Configure Date and Time Using Web Based Management

Configure date and time to synchronize the time used by the machine with the SNTP time server.

This feature is not available in some countries.

1. Start your web browser.
2. Type "https://machine's IP address" in your browser's address bar (where "machine's IP address" is the machine's IP address).

For example:

https://192.168.1.2

3. If the machine prompts you for a password, type it, and then click .
4. Click the **Administrator** tab.
5. Click **Date&Time** in the left navigation bar.

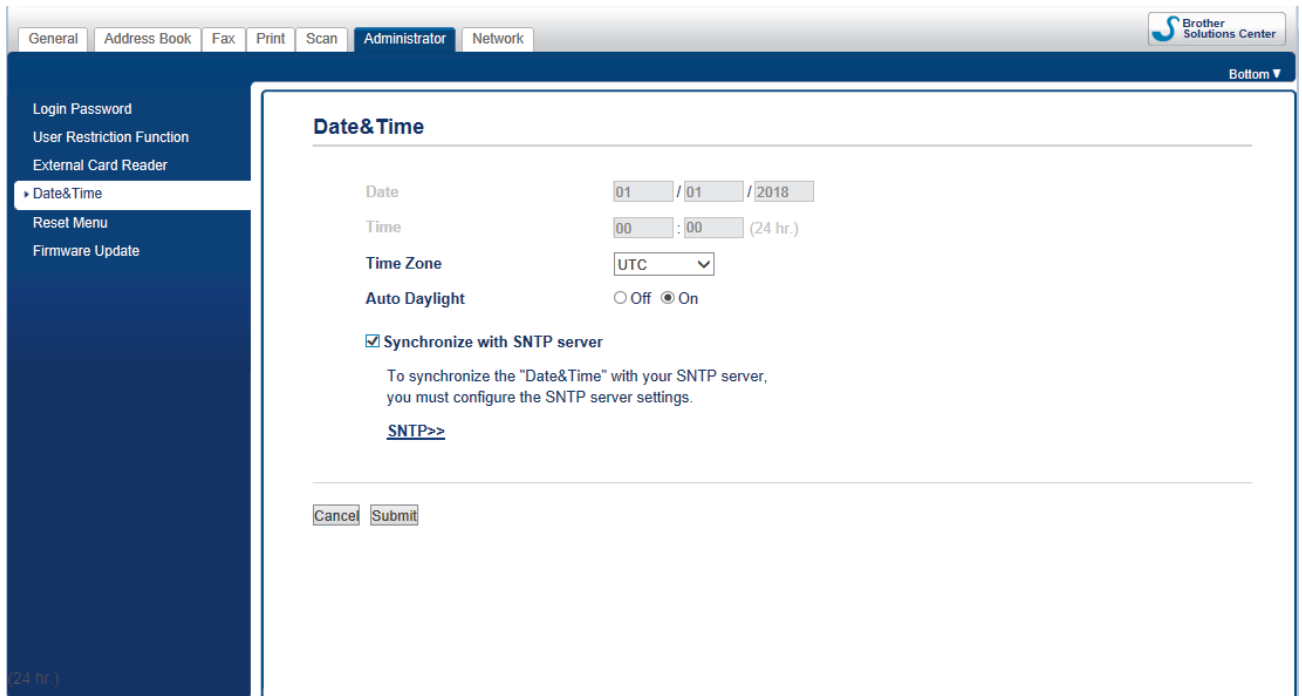

The screenshot shows the 'Date&Time' configuration page in the Administrator interface. The page has a navigation menu on the left with options like 'Login Password', 'User Restriction Function', 'External Card Reader', 'Date&Time', 'Reset Menu', and 'Firmware Update'. The main content area is titled 'Date&Time' and contains the following settings:

- Date:** 01 / 01 / 2018
- Time:** 00 : 00 (24 hr.)
- Time Zone:** UTC (dropdown menu)
- Auto Daylight:**  Off  On
- Synchronize with SNTP server**
- Text: To synchronize the "Date&Time" with your SNTP server, you must configure the SNTP server settings.
- [SNTP>>](#)
- Buttons:

6. Verify the **Time Zone** settings.



Select the time difference between your location and UTC from the **Time Zone** drop-down list. For example, the time zone for Eastern Time in the USA and Canada is UTC-05:00.

7. Select the **Synchronize with SNTP server** check box.
8. Click **Submit**.



### Related Information

- [Synchronize Time with the SNTP Server Using Web Based Management](#)



## Configure the SNTP Protocol Using Web Based Management

Configure the SNTP protocol to synchronize the time the machine uses for authentication with the time kept by the SNTP time server.

1. Start your web browser.
2. Type "https://machine's IP address" in your browser's address bar (where "machine's IP address" is the machine's IP address).

For example:

https://192.168.1.2

3. If the machine prompts you for a password, type it, and then click .
4. Click the **Network** tab.
5. Click the **Protocol** menu in the left navigation bar.
6. Select the **SNTP** check box to activate the settings.
7. Click **Submit**.
8. Restart your Brother machine to activate the configuration.
9. Next to the SNTP check box, click **Advanced Settings**.
10. Configure the settings.

Option	Description
<b>Status</b>	Displays whether the SNTP protocol is enabled or disabled.
<b>Synchronization Status</b>	Confirm the latest synchronization status.
<b>SNTP Server Method</b>	Select <b>AUTO</b> or <b>STATIC</b> . <ul style="list-style-type: none"><li>• <b>AUTO</b> If you have a DHCP server in your network, the SNTP server will obtain the address from that server automatically.</li><li>• <b>STATIC</b> Type the address you want to use.</li></ul>
<b>Primary SNTP Server Address</b> <b>Secondary SNTP Server Address</b>	Type the server address (up to 64 characters). The secondary SNTP server address is used as a backup to the primary SNTP server address. If the primary server is unavailable, the machine will contact the secondary SNTP server.
<b>Primary SNTP Server Port</b> <b>Secondary SNTP Server Port</b>	Type the port number (1-65535). The secondary SNTP server port is used as a backup to the primary SNTP server port. If the primary port is unavailable, the machine will contact the secondary SNTP port.
<b>Synchronization Interval</b>	Type the number of hours between server synchronization attempts (1-168 hours).

11. Click **Submit**.



### Related Information

- [Synchronize Time with the SNTP Server Using Web Based Management](#)

## Technical Information for Advanced Users

- [Reset the Network Settings to Factory Default](#)
- [Print the WLAN Report](#)

## Reset the Network Settings to Factory Default

You can use your machine's control panel to reset the print server to its default factory settings. This resets all information, such as the password and IP address.



- This feature restores all wired (supported models only) and wireless network settings to the factory settings.
- You can also reset the print server to its factory settings using BRAdmin Light, BRAdmin Professional, or Web Based Management.

1. Press  [Settings] > [All Settings] > [Network] > [Network Reset].
2. The message confirming reset will be displayed. Press [OK] for two seconds.  
The machine will restart.



### Related Information

- [Technical Information for Advanced Users](#)

#### Related Topics:

- [Transfer Your Faxes or Fax Journal Report](#)

## Print the WLAN Report

The WLAN Report reflects your machine's wireless status. If the wireless connection fails, check the error code on the printed report.

1. Press  [Settings] > [All Settings] > [Print Reports] > [WLAN Report] > [Yes].

The machine will print the WLAN Report.

If the WLAN Report does not print, check your machine for errors. If there are no visible errors, wait for one minute and then try to print the report again.

### Related Information

- [Technical Information for Advanced Users](#)
  - [Wireless LAN Report Error Codes](#)

#### **Related Topics:**

- [My Brother Machine Cannot Print, Scan, or PC-FAX Receive over the Network](#)
- [I Want to Check that My Network Devices are Working Correctly](#)
- [Configure IEEE 802.1x Authentication for a Wired or a Wireless Network Using Web Based Management \(Web Browser\)](#)

## Wireless LAN Report Error Codes

If the Wireless LAN Report shows that the connection failed, check the error code on the printed report and see the corresponding instructions in the table:

Error Code	Problem and Recommended Solutions
TS-01	The wireless setting is not activated. Change the wireless setting to ON. If a network cable is connected to your machine, disconnect it and change the wireless setting of your machine to ON.
TS-02	The wireless access point/router cannot be detected. 1. Check the following two points: <ul style="list-style-type: none"> <li>Unplug the power to your wireless access point/router, wait for 10 seconds, and then plug it back in.</li> <li>If your WLAN access point/router is using MAC address filtering, confirm that the MAC address of the Brother machine is allowed in the filter.</li> </ul> 2. If you manually entered the SSID and security information (SSID/authentication method/encryption method/Network Key), the information may be incorrect. Reconfirm the SSID and security information and re-enter the correct information as necessary. This device does not support a 5 GHz SSID/ESSID and you must select a 2.4 GHz SSID/ESSID. Make sure the access point/router is set to 2.4 GHz or 2.4 GHz/5 GHz mixed mode.
TS-03	The wireless network and security setting you entered may be incorrect. Reconfirm the wireless network settings. If you do not know this information, ask your network administrator.
TS-04	The Authentication/Encryption methods used by the selected wireless access point/router are not supported by your machine. Change the authentication and encryption methods of the wireless access point/router. Your machine supports the following authentication methods: <ul style="list-style-type: none"> <li>WPA-Personal TKIP or AES</li> <li>WPA2-Personal TKIP or AES</li> <li>Open WEP or None (without encryption)</li> <li>Shared key WEP</li> </ul> If your problem is not solved, the SSID or network settings you entered may be incorrect. Confirm the wireless network settings.
TS-05	The security information (SSID/Network Key) is incorrect. Confirm the SSID and Network Key.
TS-06	The wireless security information (Authentication method/Encryption method/Network Key) is incorrect. Confirm the wireless security information (Authentication method/Encryption method/Network Key).
TS-07	The machine cannot detect a WLAN access point/router that has WPS enabled. If you want to connect with WPS, you must operate both your machine and the WLAN access point/router. Confirm the connection method for WPS on WLAN access point/router and try starting again. If you do not know how to operate your WLAN access point/router using WPS, see the documentation provided with your WLAN access point/router, ask the manufacturer of your WLAN access point/router, or ask your network administrator.

Error Code	Problem and Recommended Solutions
TS-08	<p>Two or more WLAN access points that have WPS enabled are detected.</p> <ul style="list-style-type: none"><li>• Confirm that only one WLAN access point/router within range has the WPS method active and try again.</li><li>• Try again after a few minutes to avoid interference from other access points.</li></ul>



How to confirm wireless security information (SSID/authentication method/encryption method/Network Key) of your WLAN access point/router:

1. The Default security settings may be provided on a label attached to the WLAN access point/router. Or the manufacturer's name or model number of the WLAN access point/router may be used as the default security settings.
2. See the documentation provided with your WLAN access point/router for information on how to find the security settings.
  - If the WLAN access point/router is set to not broadcast the SSID, the SSID will not automatically be detected. You will have to manually enter the SSID name.
  - The Network key may also be described as the Password, Security Key or Encryption Key.

If you do not know the SSID and wireless security settings of your WLAN access point/router or how to change the configuration, see the documentation provided with your WLAN access point/router, ask the manufacturer of your access point/router or ask your Internet provider or network administrator.



## Related Information

- [Print the WLAN Report](#)

### Related Topics:

- [My Brother Machine Cannot Print, Scan, or PC-FAX Receive over the Network](#)
- [I Want to Check that My Network Devices are Working Correctly](#)

## Security

- [Network Security Features](#)

## Network Security Features

- [Before Using Network Security Features](#)
- [Secure Function Lock 3.0](#)
- [Use Active Directory Authentication](#)
- [Use LDAP Authentication](#)
- [Manage Your Network Machine Securely Using SSL/TLS](#)
- [Manage Your Network Machine Securely Using IPsec](#)
- [Send an Email Securely](#)
- [Use IEEE 802.1x Authentication for a Wired or a Wireless Network](#)



## Before Using Network Security Features

Your Brother machine employs some of the latest network security and encryption protocols available today. These network features can be integrated into your overall network security plan to help protect your data and prevent unauthorised access to the machine.



---

We recommend disabling the FTP and TFTP protocols. Accessing the machine using these protocols is not secure. However, note that if you disable FTP, the Scan to FTP feature will be disabled.

---



### Related Information

- [Network Security Features](#)
-

## Secure Function Lock 3.0

Brother's Secure Function Lock 3.0 increases security by restricting the functions available on your Brother machine.

- [Before Using Secure Function Lock 3.0](#)
- [Configure Secure Function Lock 3.0 Using Web Based Management](#)
- [Scan Using Secure Function Lock 3.0](#)
- [Configure Public Mode for Secure Function Lock 3.0](#)
- [Additional Secure Function Lock 3.0 Features](#)
- [Register an External IC Card Reader](#)

## Before Using Secure Function Lock 3.0

Use Secure Function Lock to configure passwords, set specific user page limits, and grant access to some or all of the functions listed here.

You can configure and change the following Secure Function Lock 3.0 settings using Web Based Management or BRAdmin Professional (Windows):

- **Print**  
Print includes print jobs sent via AirPrint, Google Cloud Print™ and Brother iPrint&Scan.  
If you register users' logon names in advance, the users will not need to enter their passwords when they use the print function.
- **Copy**
- **Scan**  
Scan includes scan jobs sent via Brother iPrint&Scan.
- **Fax** (supported models only)
  - **Send**
  - **Receive**
- **Media**
  - **Print from**
  - **Scan to**
- **Web Connect** (supported models only)
- **Apps** (supported models only)
- **Page Limits** (\*)
- **Colour Print**
- **Page Counters**
- **Card ID (NFC ID)** (supported models only)



### Related Information

- [Secure Function Lock 3.0](#)

## Configure Secure Function Lock 3.0 Using Web Based Management

1. Start your web browser.
2. Type "https://machine's IP address" in your browser's address bar (where "machine's IP address" is the machine's IP address).  
For example:  
https://192.168.1.2
3. If the machine prompts you for a password, type it, and then click .
4. Click the **Administrator** tab.
5. Click the **Restriction Management** or **User Restriction Function** menu in the left navigation bar.
6. Select **Secure Function Lock**.
7. Click **Submit**.
8. Click the **Restricted Functions** menu in the left navigation bar.
9. In the **User List / Restricted Functions** field, type a group name or user name.
10. In the **Print** and the other columns, select a check box to allow or clear a check box to restrict the function listed.
11. To configure the maximum page count, select the **On** check box in the **Page Limits** column, and then type the maximum number in the **Max. Pages** field.
12. Click **Submit**.
13. Click the **User List** menu in the left navigation bar.
14. In the **User List** field, type the user name.
15. In the **PIN Number** field, type a four-digit password.
16. To register the user's Card ID, type the card number in the **Card ID (NFC ID)** field (Available only for certain models) .
17. Select **User List / Restricted Functions** from the drop-down list for each user.
18. Click **Submit**.



### Related Information

- [Secure Function Lock 3.0](#)

#### Related Topics:

- [Register Your Machine with Google Cloud Print Using Web Based Management](#)

## Scan Using Secure Function Lock 3.0

### Setting Scan restrictions (for administrators)

Secure Function Lock 3.0 allows an administrator to restrict which users are allowed to scan. When the Scan feature is set to Off for the public user setting, only users who have the **Scan** check box selected will be able to scan.

### Using the Scan feature (for restricted users)

- To scan using the machine's control panel:  
Restricted users must enter their PINs on the machine's control panel to access Scan mode.
- To scan from a computer:  
Restricted users must enter their PINs on the machine's control panel before scanning from their computers. If the PIN is not entered on the machine's control panel, an error message will appear on the user's computer.



If the machine supports ID card authentication, restricted users can also access Scan mode by touching the NFC symbol on the machine's control panel with their registered ID cards.



### Related Information

- [Secure Function Lock 3.0](#)

## Configure Public Mode for Secure Function Lock 3.0

Use the Secure Function Lock screen to set up Public Mode, which limits the functions available to public users. Public users will not need to enter a password to access the features made available through Public Mode settings.



Public Mode includes print jobs sent via Google Cloud Print™, Brother iPrint&Scan, and CUPS driver (Mac).

1. Start your web browser.
2. Type "https://machine's IP address" in your browser's address bar (where "machine's IP address" is the machine's IP address).  
For example:  
https://192.168.1.2
3. If the machine prompts you for a password, type it, and then click .
4. Click the **Administrator** tab.
5. Click the **Restriction Management** or **User Restriction Function** menu in the left navigation bar.
6. Select **Secure Function Lock**.
7. Click **Submit**.
8. Click the **Restricted Functions** menu in the left navigation bar.
9. In the **Public Mode** row, select a check box to allow or clear a check box to restrict the function listed.
10. Click **Submit**.



### Related Information

- [Secure Function Lock 3.0](#)

## Additional Secure Function Lock 3.0 Features

Configure the following features in the Secure Function Lock screen:

### All Counter Reset

Click **All Counter Reset**, in the **Page Counters** column, to reset the page counter.

### Export to CSV file

Click **Export to CSV file**, to export the current and last page counter including **User List / Restricted Functions** information as a CSV file.

### Card ID (NFC ID) (supported models only)

Click the **User List** menu, and then type a users' Card ID in the **Card ID (NFC ID)** field. You can use your IC card for authentication.

### Last Counter Record

Click **Last Counter Record** if you want the machine to retain the page count after the counter has been reset.

### Counter Auto Reset

Click **Counter Auto Reset** to configure the time interval you want between page counter reset. Choose a daily, weekly, or monthly interval.



### Related Information

- [Secure Function Lock 3.0](#)

## Register an External IC Card Reader

When you connect an external IC card reader, use Web Based Management to register the card reader. Your machine supports HID class driver supported external IC card readers.

1. Start your web browser.
2. Type "https://machine's IP address" in your browser's address bar (where "machine's IP address" is the machine's IP address).  
For example:  
https://192.168.1.2
3. If the machine prompts you for a password, type it, and then click .
4. Click the **Administrator** tab.
5. Click the **External Card Reader** menu, and then enter the necessary information.
6. Click **Submit**.
7. Restart your Brother machine to activate the configuration.
8. Unplug the power cord from the electrical socket.
9. Connect the card reader to your machine, and then plug the machine's power cord into the electrical socket.

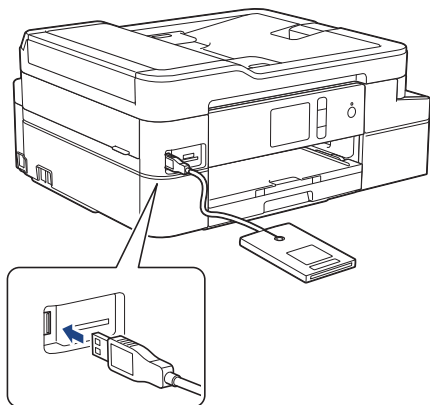

10. Touch the card to the card reader when using card authentication.

### Related Information

- [Secure Function Lock 3.0](#)



## Use Active Directory Authentication

- [Introduction to Active Directory Authentication](#)
- [Configure Active Directory Authentication Using Web Based Management](#)
- [Log On to Change the Machine Settings Using the Machine's Control Panel \(Active Directory Authentication\)](#)

## Introduction to Active Directory Authentication

Active Directory Authentication restricts the use of your Brother machine. If Active Directory Authentication is enabled, the machine's control panel will be locked. You cannot change the machine's settings until you enter a User ID and password.

Active Directory Authentication offers the following features:

- Stores incoming fax data

When Active Directory Authentication is enabled, your machine stores all incoming fax data. After you log on, the machine prints the stored fax data.

You can change the Active Directory Authentication settings using Web Based Management or BRAdmin Professional (Windows).



### Related Information

- [Use Active Directory Authentication](#)

## Configure Active Directory Authentication Using Web Based Management

Active Directory authentication supports Kerberos authentication and NTLMv2 authentication. You must configure the SNTP protocol (network time server) and DNS server configuration for authentication.

1. Start your web browser.
2. Type "https://machine's IP address" in your browser's address bar (where "machine's IP address" is the machine's IP address).  
For example:  
https://192.168.1.2
3. If the machine prompts you for a password, type it, and then click .
4. Click the **Administrator** tab.
5. Click the **User Restriction Function** menu in the left navigation bar.
6. Select **Active Directory Authentication**.
7. Click **Submit**.
8. Select the **Active Directory Authentication** menu in the left navigation bar.
9. Configure the following settings:

Option	Description
<b>Storage Fax RX Data</b>	Select this option to store incoming fax data. You can print all incoming fax data after you log on to the machine.
<b>Remember User ID</b>	Select this option to save your User ID.
<b>Active Directory Server Address</b>	Type the IP address or the server name (for example: ad.example.com) of the Active Directory Server.
<b>Active Directory Domain Name</b>	Type the Active Directory domain name.
<b>Protocol &amp; Authentication Method</b>	Select the protocol and authentication method.
<b>Get User's Home Directory</b>	Select this option to obtain your home directory as the Scan to Network destination. (available only for <b>LDAP + kerberos</b> authentication method)
<b>LDAP Server Port</b>	Type the port number to connect the Active Directory server via LDAP (available only for <b>LDAP + kerberos</b> authentication method).
<b>LDAP Search Root</b>	Type the LDAP search root (available only for <b>LDAP + kerberos</b> authentication method).

10. Click **Submit**.

### Related Information

- [Use Active Directory Authentication](#)

## Log On to Change the Machine Settings Using the Machine's Control Panel (Active Directory Authentication)

When Active Directory Authentication is enabled, the machine's control panel will be locked until you enter your User ID and password on the machine's control panel.

1. On the machine's control panel, use the touchscreen to enter your User ID and Password.
2. Press [OK].
3. When authentication is successful, the machine's control panel will be unlocked.



### Related Information

- [Use Active Directory Authentication](#)

## Use LDAP Authentication

- [Introduction to LDAP Authentication](#)
- [Configure LDAP Authentication Using Web Based Management](#)
- [Log On to Change the Machine Settings Using the Machine's Control Panel \(LDAP Authentication\)](#)

## Introduction to LDAP Authentication

LDAP Authentication restricts the use of your Brother machine. If LDAP Authentication is enabled, the machine's control panel will be locked. You cannot change the machine's settings until you enter a User ID and password.

LDAP Authentication offers the following features:

- Stores incoming fax data

When LDAP Authentication is enabled, your machine stores all incoming fax data. After you log on, the machine prints the stored fax data.

You can change the LDAP Authentication settings using Web Based Management or BRAdmin Professional (Windows).



### Related Information

- [Use LDAP Authentication](#)

## Configure LDAP Authentication Using Web Based Management

1. Start your web browser.
2. Type "https://machine's IP address" in your browser's address bar (where "machine's IP address" is the machine's IP address).

For example:

https://192.168.1.2

3. If the machine prompts you for a password, type it, and then click .
4. Click the **Administrator** tab.
5. Click the **User Restriction Function** menu in the left navigation bar.
6. Select **LDAP Authentication**.
7. Click **Submit**.
8. Click the **LDAP Authentication** menu in the left navigation bar.
9. Configure the following settings:

Option	Description
<b>Storage Fax RX Data</b>	Select this option to store incoming fax data. You can print all incoming fax data after you log on to the machine.
<b>Remember User ID</b>	Select this option to save your User ID.
<b>LDAP Server Address</b>	Type the IP address or the server name (for example: ldap.example.com) of the LDAP server.
<b>Get User's Home Directory</b> <sup>1</sup>	Select this option to obtain your home directory as the Scan to Network destination.
<b>LDAP Server Port</b>	Type the LDAP server port number.
<b>LDAP Search Root</b>	Type the LDAP search root directory.
<b>Attribute of Name (Search Key)</b>	Type the attribute you want to use as a search key.

<sup>1</sup> If this option is not available, update your machine's firmware. Go to your model's **Downloads** page on the Brother Solutions Center at [support.brother.com](http://support.brother.com).

10. Click **Submit**.



### Related Information

- [Use LDAP Authentication](#)

## Log On to Change the Machine Settings Using the Machine's Control Panel (LDAP Authentication)

When LDAP Authentication is enabled, the machine's control panel will be locked until you enter your User ID and password on the machine's control panel.

1. On the machine's control panel, use the touchscreen to enter your User ID and Password.
2. Press [OK].
3. When authentication is successful, the machine's control panel will be unlocked.



### Related Information

- [Use LDAP Authentication](#)



## Manage Your Network Machine Securely Using SSL/TLS

- [Certificates and Web Based Management](#)

## Certificates and Web Based Management

You must configure a certificate to manage your networked Brother machine securely using SSL/TLS. You must use Web Based Management to configure a certificate.

- [Supported Security Certificate Features](#)
- [Create and Install a Certificate](#)
- [Manage Multiple Certificates](#)

## Supported Security Certificate Features

Your Brother machine supports the use of multiple security certificates, which allows secure authentication and communication with the machine. The following security certificate features can be used with the machine:

- SSL/TLS communication
- IEEE 802.1x authentication
- IPsec

The Brother machine supports the following:

- Pre-installed certificate

Your machine has a pre-installed self-signed certificate. This certificate enables you to use SSL/TLS communication without creating or installing a different certificate.



---

The pre-installed self-signed certificate protects your communication up to a certain level. We recommend using a certificate that is issued by a trusted organisation for better security.

---

- Self-signed certificate

This print server issues its own certificate. Using this certificate, you can easily use the SSL/TLS communication without creating or installing a different certificate from a CA.

- Certificate from a Certificate Authority (CA)

There are two methods for installing a certificate from a CA. If you already have a certificate from a CA or if you want to use a certificate from an external trusted CA:

- When using a Certificate Signing Request (CSR) from this print server.
- When importing a certificate and a private key.

- Certificate Authority (CA) Certificate

To use a CA certificate that identifies the CA and owns its private key, you must import that CA certificate from the CA before configuring the security features of the Network.



- 
- If you are going to use SSL/TLS communication, we recommend contacting your system administrator first.
  - When you reset the print server back to its default factory settings, the certificate and the private key that are installed will be deleted. If you want to keep the same certificate and the private key after resetting the print server, export them before resetting, and then reinstall them.
- 



### Related Information

- [Certificates and Web Based Management](#)

#### Related Topics:

- [Configure IEEE 802.1x Authentication for a Wired or a Wireless Network Using Web Based Management \(Web Browser\)](#)
-

## **Create and Install a Certificate**

- [Step by Step Guide for Creating and Installing a Certificate](#)
- [Create and Install a Self-signed Certificate](#)
- [Create and Install a Certificate from a Certificate Authority \(CA\)](#)
- [Import and Export a CA Certificate](#)

## Step by Step Guide for Creating and Installing a Certificate

There are two options when choosing a security certificate: use a self-signed certificate or use a certificate from a Certificate Authority (CA).

These are a brief summary of the actions required, based on the option you choose.

### Option 1

#### Self-Signed Certificate

1. Create a self-signed certificate using Web Based Management.
2. Install the self-signed certificate on your computer.

### Option 2

#### Certificate from a CA

1. Create a Certificate Signing Request (CSR) using Web Based Management.
2. Install the certificate issued by the CA on your Brother machine using Web Based Management.
3. Install the certificate on your computer.



#### Related Information

- [Create and Install a Certificate](#)

## Create and Install a Self-signed Certificate

- [Create a Self-signed Certificate](#)
- [Install the Self-signed Certificate for Windows users with Administrator Rights](#)
- [Import and Export the Self-signed Certificate on your Brother Machine](#)

## Create a Self-signed Certificate

1. Start your web browser.
2. Type "https://machine's IP address" in your browser's address bar (where "machine's IP address" is the machine's IP address).

For example:

https://192.168.1.2



- If you are using a Domain Name System or enable a NetBIOS name, you can type another name, such as "SharedPrinter" instead of the IP address.

- For example:

https://SharedPrinter

If you enable a NetBIOS name, you can also use the node name.

- For example:

https://brnxxxxxxxxxxxx

The NetBIOS name can be found in the Network Configuration Report.

- For Mac, access Web Based Management by clicking the machine's icon on the **Status Monitor** screen.

3. If the machine prompts you for a password, type it, and then click .
4. Click the **Network** tab.
5. Click the **Security** tab.
6. Click the **Certificate** menu in the left navigation bar.
7. Click **Create Self-Signed Certificate**.
8. Enter a **Common Name** and a **Valid Date**.
  - The length of the **Common Name** is less than 64 bytes. Enter an identifier, such as an IP address, node name, or domain name to use when accessing this machine through SSL/TLS communication. The node name is displayed by default.
  - A warning will appear if you use the IPPS or HTTPS protocol and enter a different name in the URL than the **Common Name** that was used for the self-signed certificate.
9. Select your setting from the **Public Key Algorithm** drop-down list. The default setting is **RSA(2048bit)**.
10. Select your setting from the **Digest Algorithm** drop-down list. The default setting is **SHA256**.
11. Click **Submit**.
12. Click the **Network** tab.
13. Click the **Protocol** menu in the left navigation bar.
14. Click **HTTP Server Settings**.
15. Select the certificate you want to configure from the **Select the Certificate** drop-down list.
16. Click **Submit**.
17. Click **Yes** to restart your print server.

The self-signed certificate is created and saved in your machine's memory.

To use SSL/TLS communication, the self-signed certificate must be installed on your computer.







### Related Information

- [Create and Install a Self-signed Certificate](#)

## Install the Self-signed Certificate for Windows users with Administrator Rights

The following steps are for Microsoft Internet Explorer. If you use another web browser, consult the documentation for your web browser to get help with installing certificates.

1. Do one of the following:
  - (Windows 7 and Windows Server 2008)  
Click  (**Start**) > **All Programs**.
  - (Windows 8 )  
Right-click the  (**Internet Explorer**) icon on the taskbar.
  - (Windows 10 and Windows Server 2016)  
Click  > **Windows Accessories**.
  - (Windows Server 2012 and Windows Server 2012 R2)  
Click  (**Internet Explorer**), and then right-click the  (**Internet Explorer**) icon that appears on the taskbar.
2. Right-click **Internet Explorer**, and then click **Run as administrator**.



If the **More** option appears, click **More**.

If the **User Account Control** screen appears, click **Yes**.

3. Type "https://machine's IP address" in your browser's address bar to access your machine (where "machine's IP address" is the machine's IP address or the node name that you assigned for the certificate).
4. Click **Continue to this website (not recommended)**.
5. Click **Certificate error**, and then click **View certificates**.





## **Import and Export the Self-signed Certificate on your Brother Machine**

You can store the self-signed certificates on your Brother machine and manage them by importing and exporting.

- [Import the Self-signed Certificate](#)
- [Export the Self-signed Certificate](#)

## Import the Self-signed Certificate

1. Start your web browser.
2. Type "https://machine's IP address" in your browser's address bar (where "machine's IP address" is the machine's IP address).

For example:

https://192.168.1.2



- If you are using a Domain Name System or enable a NetBIOS name, you can type another name, such as "SharedPrinter" instead of the IP address.

- For example:

https://SharedPrinter

If you enable a NetBIOS name, you can also use the node name.

- For example:

https://brnxxxxxxxxxxxx

The NetBIOS name can be found in the Network Configuration Report.

- For Mac, access Web Based Management by clicking the machine's icon on the **Status Monitor** screen.

3. If the machine prompts you for a password, type it, and then click .
4. Click the **Network** tab.
5. Click the **Security** tab.
6. Click the **Certificate** menu in the left navigation bar.
7. Click **Import Certificate and Private Key**.
8. Browse to the file you want to import.
9. Type the password if the file is encrypted, and then click **Submit**.

The self-signed certificate is imported to your machine.

To use SSL/TLS communication, the self-signed certificate must also be installed on your computer. Contact your network administrator.



### Related Information

- [Import and Export the Self-signed Certificate on your Brother Machine](#)

#### Related Topics:

- [Install the Self-signed Certificate for Windows users with Administrator Rights](#)

## Export the Self-signed Certificate

1. Start your web browser.
2. Type "https://machine's IP address" in your browser's address bar (where "machine's IP address" is the machine's IP address).

For example:

https://192.168.1.2



- If you are using a Domain Name System or enable a NetBIOS name, you can type another name, such as "SharedPrinter" instead of the IP address.

- For example:

https://SharedPrinter

If you enable a NetBIOS name, you can also use the node name.

- For example:

https://brnxxxxxxxxxxxx

The NetBIOS name can be found in the Network Configuration Report.

- For Mac, access Web Based Management by clicking the machine's icon on the **Status Monitor** screen.

3. If the machine prompts you for a password, type it, and then click .
4. Click the **Network** tab.
5. Click the **Security** tab.
6. Click the **Certificate** menu in the left navigation bar.
7. Click **Export** shown with **Certificate List**.
8. If you want to encrypt the file, type a password in the **Enter password** field.  
If the **Enter password** field is blank, your output file will not be encrypted.
9. Type the password again in the **Retype password** field, and then click **Submit**.
10. Click ▼ next to **Save**, and then specify the location where you want to save the file.

The self-signed certificate is exported to your computer.

You can also import the self-signed certificate to your computer.



### Related Information

- [Import and Export the Self-signed Certificate on your Brother Machine](#)

## Create and Install a Certificate from a Certificate Authority (CA)

If you already have a certificate from an external trusted CA, you can store the certificate and private key on the machine and manage them by importing and exporting. If you do not have a certificate from an external trusted CA, create a Certificate Signing Request (CSR), send it to a CA for authentication, and install the returned certificate on your machine.

- [Create a Certificate Signing Request \(CSR\)](#)
- [Install a Certificate on Your Brother Machine](#)
- [Import and Export the Certificate and Private Key](#)

## Create a Certificate Signing Request (CSR)

A Certificate Signing Request (CSR) is a request sent to a Certificate Authority (CA) to authenticate the credentials contained within the certificate.

We recommend installing a Root Certificate from the CA on your computer before creating the CSR.

1. Start your web browser.
2. Type "https://machine's IP address" in your browser's address bar (where "machine's IP address" is the machine's IP address).

For example:

https://192.168.1.2



- If you are using a Domain Name System or enable a NetBIOS name, you can type another name, such as "SharedPrinter" instead of the IP address.

- For example:

https://SharedPrinter

If you enable a NetBIOS name, you can also use the node name.

- For example:

https://brnxxxxxxxxxxxx

The NetBIOS name can be found in the Network Configuration Report.

- For Mac, access Web Based Management by clicking the machine's icon on the **Status Monitor** screen.

3. If the machine prompts you for a password, type it, and then click .

4. Click the **Network** tab.
5. Click the **Security** tab.
6. Click the **Certificate** menu in the left navigation bar.
7. Click **Create CSR**.
8. Type a **Common Name** (required) and add other information about your **Organization** (optional).



- Your company details are required so that a CA can confirm your identity and verify it to the outside world.
- The length of the **Common Name** must be less than 64 bytes. Enter an identifier, such as an IP address, node name, or domain name to use when accessing this printer through SSL/TLS communication. The node name is displayed by default. The **Common Name** is required.
- A warning will appear if you type a different name in the URL than the Common Name that was used for the certificate.
- The length of the **Organization**, the **Organization Unit**, the **City/Locality** and the **State/Province** must be less than 64 bytes.
- The **Country/Region** should be a two character ISO 3166 country code.
- If you are configuring an X.509v3 certificate extension, select the **Configure extended partition** check box, and then select **Auto (Register IPv4)** or **Manual**.

9. Select your setting from the **Public Key Algorithm** drop-down list. The default setting is **RSA(2048bit)**.
10. Select your setting from the **Digest Algorithm** drop-down list. The default setting is **SHA256**.
11. Click **Submit**.

The CSR appears on your screen. Save the CSR as a file or copy and paste it into an online CSR form offered by a Certificate Authority.

---

12. Click **Save**.

13. Click ▼ next to **Save**, and then specify the location where you want to save the file.



- Follow your CA's policy regarding the method to send a CSR to your CA.
  - If you are using the Enterprise root CA of Windows Server 2008/2012/2012 R2/2016, we recommend using the Web Server for the certificate template to securely create the Client Certificate. If you are creating a Client Certificate for an IEEE 802.1x environment with EAP-TLS authentication, we recommend using User for the certificate template. For more detailed information, go to your model's **FAQs & Troubleshooting** page on the Brother support website at [support.brother.com](http://support.brother.com). Search for "SSL".
- 



### Related Information

- [Create and Install a Certificate from a Certificate Authority \(CA\)](#)
-

## Install a Certificate on Your Brother Machine

When you receive a certificate from a CA, follow the steps below to install it into the print server:

Only a certificate issued with your machine's CSR can be installed onto the machine. When you want to create another CSR, make sure that the certificate is installed before creating another CSR. Create another CSR only after installing the certificate on the machine. If you do not, the CSR you create before installing will be invalid.

1. Start your web browser.
2. Type "https://machine's IP address" in your browser's address bar (where "machine's IP address" is the machine's IP address).

For example:

https://192.168.1.2



- If you are using a Domain Name System or enable a NetBIOS name, you can type another name, such as "SharedPrinter" instead of the IP address.

- For example:

https://SharedPrinter

If you enable a NetBIOS name, you can also use the node name.

- For example:

https://brnxxxxxxxxxxxx

The NetBIOS name can be found in the Network Configuration Report.

- For Mac, access Web Based Management by clicking the machine's icon on the **Status Monitor** screen.

3. If the machine prompts you for a password, type it, and then click .

4. Click the **Network** tab.

5. Click the **Security** tab.

6. Click the **Certificate** menu in the left navigation bar.

7. Click **Install Certificate**.

8. Browse to the file that contains the certificate issued by the CA, and then click **Submit**.

The certificate has been created successfully and saved in your machine's memory successfully.

To use SSL/TLS communication, the Root Certificate from the CA must be installed on your computer. Contact your network administrator.



### Related Information

- [Create and Install a Certificate from a Certificate Authority \(CA\)](#)



## **Import and Export the Certificate and Private Key**

Store the certificate and private key on your machine and manage them by importing and exporting them.

- [Import a Certificate and Private Key](#)
- [Export the Certificate and Private Key](#)

## Import a Certificate and Private Key

1. Start your web browser.
2. Type "https://machine's IP address" in your browser's address bar (where "machine's IP address" is the machine's IP address).

For example:

https://192.168.1.2



- If you are using a Domain Name System or enable a NetBIOS name, you can type another name, such as "SharedPrinter" instead of the IP address.

- For example:

https://SharedPrinter

If you enable a NetBIOS name, you can also use the node name.

- For example:

https://brnxxxxxxxxxxxx

The NetBIOS name can be found in the Network Configuration Report.

- For Mac, access Web Based Management by clicking the machine's icon on the **Status Monitor** screen.

3. If the machine prompts you for a password, type it, and then click .
4. Click the **Network** tab.
5. Click the **Security** tab.
6. Click the **Certificate** menu in the left navigation bar.
7. Click **Import Certificate and Private Key**.
8. Browse to the file you want to import.
9. Type the password if the file is encrypted, and then click **Submit**.

The certificate and private key are imported to your machine.

To use SSL/TLS communication, the Root Certificate from the CA must also be installed on your computer. Contact your network administrator.



### Related Information

- [Import and Export the Certificate and Private Key](#)

## Export the Certificate and Private Key

1. Start your web browser.
2. Type "https://machine's IP address" in your browser's address bar (where "machine's IP address" is the machine's IP address).

For example:

https://192.168.1.2



- If you are using a Domain Name System or enable a NetBIOS name, you can type another name, such as "SharedPrinter" instead of the IP address.

- For example:

https://SharedPrinter

If you enable a NetBIOS name, you can also use the node name.

- For example:

https://brnxxxxxxxxxxxx

The NetBIOS name can be found in the Network Configuration Report.

- For Mac, access Web Based Management by clicking the machine's icon on the **Status Monitor** screen.

3. If the machine prompts you for a password, type it, and then click .
4. Click the **Network** tab.
5. Click the **Security** tab.
6. Click the **Certificate** menu in the left navigation bar.
7. Click **Export** shown with **Certificate List**.
8. Enter the password if you want to encrypt the file.  
If a blank password is used, the output is not encrypted.
9. Enter the password again for confirmation, and then click **Submit**.
10. Click ▼ next to **Save**, and then specify the location where you want to save the file.

The certificate and private key are exported to your computer.

You can also import the certificate to your computer.



### Related Information

- [Import and Export the Certificate and Private Key](#)

## Import and Export a CA Certificate

You can import, export and store CA certificates on your Brother machine.

- [Import a CA Certificate](#)
- [Export a CA Certificate](#)

## Import a CA Certificate

1. Start your web browser.
2. Type "https://machine's IP address" in your browser's address bar (where "machine's IP address" is the machine's IP address).

For example:

https://192.168.1.2



- If you are using a Domain Name System or enable a NetBIOS name, you can type another name, such as "SharedPrinter" instead of the IP address.

- For example:

https://SharedPrinter

If you enable a NetBIOS name, you can also use the node name.

- For example:

https://brnxxxxxxxxxxxx

The NetBIOS name can be found in the Network Configuration Report.

- For Mac, access Web Based Management by clicking the machine's icon on the **Status Monitor** screen.

3. If the machine prompts you for a password, type it, and then click .
4. Click the **Network** tab.
5. Click the **Security** tab.
6. Click the **CA Certificate** menu in the left navigation bar.
7. Click **Import CA Certificate**.
8. Browse to the file you want to import.
9. Click **Submit**.



### Related Information

- [Import and Export a CA Certificate](#)

## Export a CA Certificate

1. Start your web browser.
2. Type "https://machine's IP address" in your browser's address bar (where "machine's IP address" is the machine's IP address).

For example:

https://192.168.1.2



- If you are using a Domain Name System or enable a NetBIOS name, you can type another name, such as "SharedPrinter" instead of the IP address.

- For example:

https://SharedPrinter

If you enable a NetBIOS name, you can also use the node name.

- For example:

https://brnxxxxxxxxxxxx

The NetBIOS name can be found in the Network Configuration Report.

- For Mac, access Web Based Management by clicking the machine's icon on the **Status Monitor** screen.

3. If the machine prompts you for a password, type it, and then click .
4. Click the **Network** tab.
5. Click the **Security** tab.
6. Click the **CA Certificate** menu in the left navigation bar.
7. Select the certificate you want to export and click **Export**.
8. Click **Submit**.
9. Click ▼ next to **Save**, and then specify the location where you want to save the file.



### Related Information

- [Import and Export a CA Certificate](#)

## Manage Multiple Certificates

The multiple certificate feature allows you to use Web Based Management to manage each certificate installed on your machine. In Web Based Management, navigate to the **Certificate** or **CA Certificate** screen to view certificate content, delete, or export your certificates.

	Maximum Number of Certificates Stored UP on Brother Machine
Self-signed Certificate or Certificate Issued by a CA	5
CA Certificate	6

We recommend storing one less certificate than allowed, reserving an empty spot in case of certificate expiration. When a certificate expires, import a new certificate into the reserved spot, and then delete the expired certificate. This ensures that you avoid configuration failure.



- When you use HTTPS/IPPS or IEEE 802.1x, you must select which certificate you are using.
- When you use SSL for SMTP communications, you do not have to choose the certificate. The necessary certificate will be chosen automatically.



### Related Information

- [Certificates and Web Based Management](#)

## Manage Your Network Machine Securely Using IPsec

- [Introduction to IPsec](#)
- [Configure IPsec Using Web Based Management](#)
- [Configure an IPsec Address Template Using Web Based Management](#)
- [Configure an IPsec Template Using Web Based Management](#)



## Introduction to IPsec

IPsec (Internet Protocol Security) is a security protocol that uses an optional Internet Protocol function to prevent manipulation and ensure the confidentiality of data transmitted as IP packets. IPsec encrypts data carried over the network, such as print data sent from computers to a printer. Because the data is encrypted at the network layer, applications that employ a higher-level protocol use IPsec even if the user is not aware of its use.

IPsec supports the following functions:

- IPsec transmissions

According to the IPsec setting conditions, the network-connected computer sends data to and receives data from the specified device using IPsec. When the devices start communicating using IPsec, keys are exchanged using Internet Key Exchange (IKE) first, and then the encrypted data is transmitted using the keys.

In addition, IPsec has two operation modes: the Transport mode and Tunnel mode. The Transport mode is used mainly for communication between devices and the Tunnel mode is used in environments such as a Virtual Private Network (VPN).



---

For IPsec transmissions, the following conditions are necessary:

- A computer that can communicate using IPsec is connected to the network.
  - Your Brother machine is configured for IPsec communication.
  - The computer connected to your Brother machine is configured for IPsec connections.
- 

- IPsec settings

The settings that are necessary for connections using IPsec. These settings can be configured using Web Based Management.



---

To configure the IPsec settings, you must use the browser on a computer that is connected to the network.

---



### Related Information

- [Manage Your Network Machine Securely Using IPsec](#)
-

## Configure IPsec Using Web Based Management

The IPsec connection conditions are comprised of two **Template** types: **Address** and **IPsec**. You can configure up to 10 connection conditions.

1. Start your web browser.
2. Type "https://machine's IP address" in your browser's address bar (where "machine's IP address" is the machine's IP address).

For example:

https://192.168.1.2

3. If the machine prompts you for a password, type it, and then click .
4. Click the **Network** tab.
5. Click the **Security** tab.
6. Click the **IPsec** menu in the left navigation bar.
7. Configure the settings.

Option	Description
<b>Status</b>	Enable or disable IPsec.
<b>Negotiation Mode</b>	Select <b>Negotiation Mode</b> for IKE Phase 1. IKE is a protocol that is used to exchange encryption keys in order to carry out encrypted communication using IPsec.  In <b>Main</b> mode, the processing speed is slow, but the security is high. In <b>Aggressive</b> mode, the processing speed is faster than <b>Main</b> mode, but the security is lower.
<b>All Non-IPsec Traffic</b>	Select the action to be taken for non-IPsec packets. When using Web Services, you must select <b>Allow</b> for <b>All Non-IPsec Traffic</b> . If you select <b>Drop</b> , Web Services cannot be used.
<b>Broadcast/Multicast Bypass</b>	Select <b>Enabled</b> or <b>Disabled</b> .
<b>Protocol Bypass</b>	Select the check box for the option or options you want.
<b>Rules</b>	Select the <b>Enabled</b> check box to activate the template. When you select multiple check boxes, the lower numbered check boxes have priority if the settings for the selected check boxes conflict.  Click on the corresponding drop-down list to select the <b>Address Template</b> that is used for the IPsec connection conditions. To add an <b>Address Template</b> , click <b>Add Template</b> .  Click on the corresponding drop-down list to select the <b>IPsec Template</b> that is used for the IPsec connection conditions. To add an <b>IPsec Template</b> , click <b>Add Template</b> .

8. Click **Submit**.

If the machine must be restarted to register the new settings, the restart confirmation screen will appear.

If there is a blank item in the template you enabled in the **Rules** table, an error message appears. Confirm your choices and click **Submit** again.



### Related Information

- [Manage Your Network Machine Securely Using IPsec](#)

## Configure an IPsec Address Template Using Web Based Management

1. Start your web browser.
2. Type "https://machine's IP address" in your browser's address bar (where "machine's IP address" is the machine's IP address).

For example:

https://192.168.1.2

3. If the machine prompts you for a password, type it, and then click .

4. Click the **Network** tab.
5. Click the **Security** tab.
6. Click the **IPsec Address Template** menu in the left navigation bar.

The Template List appears, displaying 10 Address Templates.

Click the **Delete** button to delete an **Address Template**. When an **Address Template** is in use, it cannot be deleted.

7. Click the **Address Template** that you want to create. The **IPsec Address Template** appears.
8. Configure the settings.

Option	Description
<b>Template Name</b>	Type a name for the template (up to 16 characters).
<b>Local IP Address</b>	<ul style="list-style-type: none"> <li>• <b>IP Address</b> Specify the IP address. Select <b>ALL IPv4 Address</b>, <b>ALL IPv6 Address</b>, <b>ALL Link Local IPv6</b>, or <b>Custom</b> from the drop-down list. If you select <b>Custom</b> from the drop-down list, type the IP address (IPv4 or IPv6) in the text box.</li> <li>• <b>IP Address Range</b> Type the starting and ending IP addresses for the IP address range in the text boxes. If the starting and ending IP addresses are not standardized to IPv4 or IPv6, or the ending IP address is smaller than the starting address, an error will occur.</li> <li>• <b>IP Address / Prefix</b> Specify the IP address using CIDR notation. For example: 192.168.1.1/24 Because the prefix is specified in the form of a 24-bit subnet mask (255.255.255.0) for 192.168.1.1, the addresses 192.168.1.xxx are valid.</li> </ul>
<b>Remote IP Address</b>	<ul style="list-style-type: none"> <li>• <b>Any</b> If you select <b>Any</b>, all IP addresses are enabled.</li> <li>• <b>IP Address</b> Type the specified IP address (IPv4 or IPv6) in the text box.</li> <li>• <b>IP Address Range</b> Type the starting and ending IP addresses for the IP address range. If the starting and ending IP addresses are not standardized to IPv4 or IPv6, or the ending IP address is smaller than the starting address, an error will occur.</li> <li>• <b>IP Address / Prefix</b> Specify the IP address using CIDR notation. For example: 192.168.1.1/24</li> </ul>

---

Option	Description
	Because the prefix is specified in the form of a 24-bit subnet mask (255.255.255.0) for 192.168.1.1, the addresses 192.168.1.xxx are valid.

9. Click **Submit**.



---

When you change the settings for the template currently in use, restart your machine to active the configuration.

---



### Related Information

- [Manage Your Network Machine Securely Using IPsec](#)
-

## Configure an IPsec Template Using Web Based Management



1. Start your web browser.
2. Type "https://machine's IP address" in your browser's address bar (where "machine's IP address" is the machine's IP address).  
For example:  
https://192.168.1.2
3. If the machine prompts you for a password, type it, and then click .
4. Click the **Network** tab.
5. Click the **Security** tab.
6. Click **IPsec Template** in the left navigation bar.  
The Template List appears, displaying 10 IPsec Templates.  
Click the **Delete** button to delete an **IPsec Template**. When an **IPsec Template** is in use, it cannot be deleted.
7. Click **IPsec Template** that you want to create. The **IPsec Template** screen appears. The configuration fields differ based on the **Use Prefixed Template** and **Internet Key Exchange (IKE)** you select.
8. In the **Template Name** field, type a name for the template (up to 16 characters).
9. If you selected **Custom** in the **Use Prefixed Template** drop-down list, select the **Internet Key Exchange (IKE)** options, and then change the settings if needed.
10. Click **Submit**.





### Related Information

- [Manage Your Network Machine Securely Using IPsec](#)
  - [IKEv1 Settings for an IPsec Template](#)
  - [IKEv2 Settings for an IPsec Template](#)
  - [Manual Settings for an IPsec Template](#)

## IKEv1 Settings for an IPsec Template

Option	Description
<b>Template Name</b>	Type a name for the template (up to 16 characters).
<b>Use Prefixed Template</b>	<p>Select <b>Custom</b>, <b>IKEv1 High Security</b> or <b>IKEv1 Medium Security</b>. The setting items are different depending on the selected template.</p> <hr/> <p> The default template differs depending on whether you chose <b>Main</b> or <b>Aggressive</b> for <b>Negotiation Mode</b> on the <b>IPsec</b> configuration screen.</p>
<b>Internet Key Exchange (IKE)</b>	<p>IKE is a communication protocol that is used to exchange encryption keys in order to carry out encrypted communication using IPsec. To carry out encrypted communication for that time only, the encryption algorithm that is necessary for IPsec is determined and the encryption keys are shared. For IKE, the encryption keys are exchanged using the Diffie-Hellman key exchange method, and encrypted communication that is limited to IKE is carried out.</p> <p>If you selected <b>Custom</b> in <b>Use Prefixed Template</b>, select <b>IKEv1</b>.</p>
<b>Authentication Type</b>	<ul style="list-style-type: none"> <li>• <b>Diffie-Hellman Group</b> <p>This key exchange method allows secret keys to be securely exchanged over an unprotected network. The Diffie-Hellman key exchange method uses a discrete logarithm problem, not the secret key, to send and receive open information that was generated using a random number and the secret key.</p> <p>Select <b>Group1</b>, <b>Group2</b>, <b>Group5</b>, or <b>Group14</b>.</p> </li> <li>• <b>Encryption</b> <p>Select <b>DES</b>, <b>3DES</b>, <b>AES-CBC 128</b>, or <b>AES-CBC 256</b>.</p> </li> <li>• <b>Hash</b> <p>Select <b>MD5</b>, <b>SHA1</b>, <b>SHA256</b>, <b>SHA384</b> or <b>SHA512</b>.</p> </li> <li>• <b>SA Lifetime</b> <p>Specify the IKE SA lifetime.</p> <p>Type the time (seconds) and number of kilobytes (KByte).</p> </li> </ul>
<b>Encapsulating Security</b>	<ul style="list-style-type: none"> <li>• <b>Protocol</b> <p>Select <b>ESP</b>, <b>AH</b>, or <b>AH+ESP</b>.</p> <hr/> <p> - ESP is a protocol for carrying out encrypted communication using IPsec. ESP encrypts the payload (communicated contents) and adds additional information. The IP packet is comprised of the header and the encrypted payload, which follows the header. In addition to the encrypted data, the IP packet also includes information regarding the encryption method and encryption key, the authentication data, and so on.</p> <p>- AH is part of the IPsec protocol that authenticates the sender and prevents manipulation (ensures the completeness) of the data. In the IP packet, the data is inserted immediately after the header. In addition, the packets include hash values, which are calculated using an equation from the communicated contents, secret key, and so on, in order to prevent the falsification of the sender and manipulation of the data. Unlike ESP, the communicated contents are not encrypted, and the data is sent and received as plain text.</p> </li> </ul>

Option	Description
	<ul style="list-style-type: none"> <li>• <b>Encryption</b> Select <b>DES</b>, <b>3DES</b>, <b>AES-CBC 128</b>, or <b>AES-CBC 256</b>.</li> <li>• <b>Hash</b> Select <b>None</b>, <b>MD5</b>, <b>SHA1</b>, <b>SHA256</b>, <b>SHA384</b> or <b>SHA512</b>.</li> <li>• <b>SA Lifetime</b> Specify the IKE SA lifetime. Type the time (seconds) and number of kilobytes (KByte).</li> <li>• <b>Encapsulation Mode</b> Select <b>Transport</b> or <b>Tunnel</b>.</li> <li>• <b>Remote Router IP-Address</b> Type the IP address (IPv4 or IPv6) of the remote router. Enter this information only when the <b>Tunnel</b> mode is selected.</li> </ul> <hr/> <p> SA (Security Association) is an encrypted communication method using IPsec or IPv6 that exchanges and shares information, such as the encryption method and encryption key, in order to establish a secure communication channel before communication begins. SA may also refer to a virtual encrypted communication channel that has been established. The SA used for IPsec establishes the encryption method, exchanges the keys, and carries out mutual authentication according to the IKE (Internet Key Exchange) standard procedure. In addition, the SA is updated periodically.</p>
<b>Perfect Forward Secrecy (PFS)</b>	<p>PFS does not derive keys from previous keys that were used to encrypt messages. In addition, if a key that is used to encrypt a message was derived from a parent key, that parent key is not used to derive other keys. Therefore, even if a key is compromised, the damage will be limited only to the messages that were encrypted using that key.</p> <p>Select <b>Enabled</b> or <b>Disabled</b>.</p>
<b>Authentication Method</b>	<p>Select the authentication method. Select <b>Pre-Shared Key</b> or <b>Certificates</b>.</p>
<b>Pre-Shared Key</b>	<p>When encrypting communication, the encryption key is exchanged and shared beforehand using another channel.</p> <p>If you selected <b>Pre-Shared Key</b> for the <b>Authentication Method</b>, type the <b>Pre-Shared Key</b> (up to 32 characters).</p> <ul style="list-style-type: none"> <li>• <b>Local/ID Type/ID</b> Select the sender's ID type, and then type the ID. Select <b>IPv4 Address</b>, <b>IPv6 Address</b>, <b>FQDN</b>, <b>E-mail Address</b>, or <b>Certificate</b> for the type. If you select <b>Certificate</b>, type the common name of the certificate in the <b>ID</b> field.</li> <li>• <b>Remote/ID Type/ID</b> Select the recipient's ID type, and then type the ID. Select <b>IPv4 Address</b>, <b>IPv6 Address</b>, <b>FQDN</b>, <b>E-mail Address</b>, or <b>Certificate</b> for the type. If you select <b>Certificate</b>, type the common name of the certificate in the <b>ID</b> field.</li> </ul>
<b>Certificate</b>	<p>If you selected <b>Certificates</b> for <b>Authentication Method</b>, select the certificate.</p> <hr/> <p> You can select only the certificates that were created using the <b>Certificate</b> page of Web Based Management's Security configuration screen.</p>





## Related Information

- [Configure an IPsec Template Using Web Based Management](#)
-



## IKEv2 Settings for an IPsec Template

Option	Description
<b>Template Name</b>	Type a name for the template (up to 16 characters).
<b>Use Prefixed Template</b>	Select <b>Custom</b> , <b>IKEv2 High Security</b> , or <b>IKEv2 Medium Security</b> . The setting items are different depending on the selected template.
<b>Internet Key Exchange (IKE)</b>	IKE is a communication protocol that is used to exchange encryption keys in order to carry out encrypted communication using IPsec. To carry out encrypted communication for that time only, the encryption algorithm that is necessary for IPsec is determined and the encryption keys are shared. For IKE, the encryption keys are exchanged using the Diffie-Hellman key exchange method, and encrypted communication that is limited to IKE is carried out. If you selected <b>Custom</b> in <b>Use Prefixed Template</b> , select <b>IKEv2</b> .
<b>Authentication Type</b>	<ul style="list-style-type: none"> <li>• <b>Diffie-Hellman Group</b> This key exchange method allows secret keys to be securely exchanged over an unprotected network. The Diffie-Hellman key exchange method uses a discrete logarithm problem, not the secret key, to send and receive open information that was generated using a random number and the secret key. Select <b>Group1</b>, <b>Group2</b>, <b>Group5</b>, or <b>Group14</b>.</li> <li>• <b>Encryption</b> Select <b>DES</b>, <b>3DES</b>, <b>AES-CBC 128</b>, or <b>AES-CBC 256</b>.</li> <li>• <b>Hash</b> Select <b>MD5</b>, <b>SHA1</b>, <b>SHA256</b>, <b>SHA384</b> or <b>SHA512</b>.</li> <li>• <b>SA Lifetime</b> Specify the IKE SA lifetime. Type the time (seconds) and number of kilobytes (KByte).</li> </ul>
<b>Encapsulating Security</b>	<ul style="list-style-type: none"> <li>• <b>Protocol</b> Select <b>ESP</b>.   ESP is a protocol for carrying out encrypted communication using IPsec. ESP encrypts the payload (communicated contents) and adds additional information. The IP packet is comprised of the header and the encrypted payload, which follows the header. In addition to the encrypted data, the IP packet also includes information regarding the encryption method and encryption key, the authentication data, and so on.</li> <li>• <b>Encryption</b> Select <b>DES</b>, <b>3DES</b>, <b>AES-CBC 128</b>, or <b>AES-CBC 256</b>.</li> <li>• <b>Hash</b> Select <b>MD5</b>, <b>SHA1</b>, <b>SHA256</b>, <b>SHA384</b>, or <b>SHA512</b>.</li> <li>• <b>SA Lifetime</b> Specify the IKE SA lifetime. Type the time (seconds) and number of kilobytes (KByte).</li> <li>• <b>Encapsulation Mode</b> Select <b>Transport</b> or <b>Tunnel</b>.</li> <li>• <b>Remote Router IP-Address</b> Type the IP address (IPv4 or IPv6) of the remote router. Enter this information only when the <b>Tunnel</b> mode is selected.</li> </ul>

Option	Description
	 <p>SA (Security Association) is an encrypted communication method using IPsec or IPv6 that exchanges and shares information, such as the encryption method and encryption key, in order to establish a secure communication channel before communication begins. SA may also refer to a virtual encrypted communication channel that has been established. The SA used for IPsec establishes the encryption method, exchanges the keys, and carries out mutual authentication according to the IKE (Internet Key Exchange) standard procedure. In addition, the SA is updated periodically.</p>
<b>Perfect Forward Secrecy (PFS)</b>	<p>PFS does not derive keys from previous keys that were used to encrypt messages. In addition, if a key that is used to encrypt a message was derived from a parent key, that parent key is not used to derive other keys. Therefore, even if a key is compromised, the damage will be limited only to the messages that were encrypted using that key.</p> <p>Select <b>Enabled</b> or <b>Disabled</b>.</p>
<b>Authentication Method</b>	<p>Select the authentication method. Select <b>Pre-Shared Key</b>, <b>Certificates</b>, <b>EAP - MD5</b>, or <b>EAP - MS-CHAPv2</b>.</p>  <p>EAP is an authentication protocol that is an extension of PPP. By using EAP with IEEE802.1x, a different key is used for user authentication during each session.</p> <p>The following settings are necessary only when <b>EAP - MD5</b> or <b>EAP - MS-CHAPv2</b> is selected in <b>Authentication Method</b>:</p> <ul style="list-style-type: none"> <li>• <b>Mode</b> Select <b>Server-Mode</b> or <b>Client-Mode</b>.</li> <li>• <b>Certificate</b> Select the certificate.</li> <li>• <b>User Name</b> Type the user name (up to 32 characters).</li> <li>• <b>Password</b> Type the password (up to 32 characters). The password must be entered two times for confirmation.</li> </ul>
<b>Pre-Shared Key</b>	<p>When encrypting communication, the encryption key is exchanged and shared beforehand using another channel.</p> <p>If you selected <b>Pre-Shared Key</b> for the <b>Authentication Method</b>, type the <b>Pre-Shared Key</b> (up to 32 characters).</p> <ul style="list-style-type: none"> <li>• <b>Local/ID Type/ID</b> Select the sender's ID type, and then type the ID. Select <b>IPv4 Address</b>, <b>IPv6 Address</b>, <b>FQDN</b>, <b>E-mail Address</b>, or <b>Certificate</b> for the type. If you select <b>Certificate</b>, type the common name of the certificate in the <b>ID</b> field.</li> <li>• <b>Remote/ID Type/ID</b> Select the recipient's ID type, and then type the ID. Select <b>IPv4 Address</b>, <b>IPv6 Address</b>, <b>FQDN</b>, <b>E-mail Address</b>, or <b>Certificate</b> for the type. If you select <b>Certificate</b>, type the common name of the certificate in the <b>ID</b> field.</li> </ul>
<b>Certificate</b>	<p>If you selected <b>Certificates</b> for <b>Authentication Method</b>, select the certificate.</p>

---



Option	Description
	 You can select only the certificates that were created using the <b>Certificate</b> page of Web Based Management's Security configuration screen.





### Related Information

- [Configure an IPsec Template Using Web Based Management](#)
-

## Manual Settings for an IPsec Template

Option	Description
<b>Template Name</b>	Type a name for the template (up to 16 characters).
<b>Use Prefixed Template</b>	Select <b>Custom</b> .
<b>Internet Key Exchange (IKE)</b>	<p>IKE is a communication protocol that is used to exchange encryption keys in order to carry out encrypted communication using IPsec. To carry out encrypted communication for that time only, the encryption algorithm that is necessary for IPsec is determined and the encryption keys are shared. For IKE, the encryption keys are exchanged using the Diffie-Hellman key exchange method, and encrypted communication that is limited to IKE is carried out.</p> <p>Select <b>Manual</b>.</p>
<b>Authentication Key (ESP, AH)</b>	<p>Type the <b>In/Out</b> values.</p> <p>These settings are necessary when <b>Custom</b> is selected for <b>Use Prefixed Template</b>, <b>Manual</b> is selected for <b>Internet Key Exchange (IKE)</b>, and a setting other than <b>None</b> is selected for <b>Hash</b> for <b>Encapsulating Security</b> section.</p> <hr/> <p> The number of characters you can set differs depending on the setting you chose for <b>Hash</b> in the <b>Encapsulating Security</b> section.</p> <p>If the length of the specified authentication key is different than the selected hash algorithm, an error will occur.</p> <ul style="list-style-type: none"> <li>• <b>MD5</b>: 128 bits (16 bytes)</li> <li>• <b>SHA1</b>: 160 bits (20 bytes)</li> <li>• <b>SHA256</b>: 256 bits (32 bytes)</li> <li>• <b>SHA384</b>: 384 bits (48 bytes)</li> <li>• <b>SHA512</b>: 512 bits (64 bytes)</li> </ul> <p>When you specify the key in ASCII Code, enclose the characters in double quotation marks (").</p> <hr/>
<b>Code key (ESP)</b>	<p>Type the <b>In/Out</b> values.</p> <p>These settings are necessary when <b>Custom</b> is selected in <b>Use Prefixed Template</b>, <b>Manual</b> is selected in <b>Internet Key Exchange (IKE)</b>, and <b>ESP</b> is selected in <b>Protocol</b> in <b>Encapsulating Security</b>.</p> <hr/> <p> The number of characters you can set differs depending on the setting you chose for <b>Encryption</b> in the <b>Encapsulating Security</b> section.</p> <p>If the length of the specified code key is different than the selected encryption algorithm, an error will occur.</p> <ul style="list-style-type: none"> <li>• <b>DES</b>: 64 bits (8 bytes)</li> <li>• <b>3DES</b>: 192 bits (24 bytes)</li> <li>• <b>AES-CBC 128</b>: 128 bits (16 bytes)</li> <li>• <b>AES-CBC 256</b>: 256 bits (32 bytes)</li> </ul> <p>When you specify the key in ASCII Code, enclose the characters in double quotation marks (").</p> <hr/>
<b>SPI</b>	<p>These parameters are used to identify security information. Generally, a host has multiple Security Associations (SAs) for several types of IPsec communication. Therefore, it is necessary to identify the applicable SA when an IPsec packet is received. The SPI parameter, which identifies</p>

Option	Description
	<p>the SA, is included in the Authentication Header (AH) and Encapsulating Security Payload (ESP) header.</p> <p>These settings are necessary when <b>Custom</b> is selected for <b>Use Prefixed Template</b>, and <b>Manual</b> is selected for <b>Internet Key Exchange (IKE)</b>.</p> <p>Enter the <b>In/Out</b> values. (3-10 characters)</p>
<p><b>Encapsulating Security</b></p>	<ul style="list-style-type: none"> <li>• <b>Protocol</b> Select <b>ESP</b> or <b>AH</b>.</li> </ul> <hr/> <ul style="list-style-type: none"> <li>  <ul style="list-style-type: none"> <li>- ESP is a protocol for carrying out encrypted communication using IPsec. ESP encrypts the payload (communicated contents) and adds additional information. The IP packet is comprised of the header and the encrypted payload, which follows the header. In addition to the encrypted data, the IP packet also includes information regarding the encryption method and encryption key, the authentication data, and so on.</li> <li>- AH is part of the IPsec protocol that authenticates the sender and prevents manipulation of the data (ensures the completeness of the data). In the IP packet, the data is inserted immediately after the header. In addition, the packets include hash values, which are calculated using an equation from the communicated contents, secret key, and so on, in order to prevent the falsification of the sender and manipulation of the data. Unlike ESP, the communicated contents are not encrypted, and the data is sent and received as plain text.</li> </ul> </li> </ul> <hr/> <ul style="list-style-type: none"> <li>• <b>Encryption</b> Select <b>DES</b>, <b>3DES</b>, <b>AES-CBC 128</b>, or <b>AES-CBC 256</b>.</li> <li>• <b>Hash</b> Select <b>None</b>, <b>MD5</b>, <b>SHA1</b>, <b>SHA256</b>, <b>SHA384</b>, or <b>SHA512</b>. <b>None</b> can be selected only when <b>ESP</b> is selected in <b>Protocol</b>.</li> <li>• <b>SA Lifetime</b> Specify the IKE SA lifetime. Type the time (seconds) and number of kilobytes (KByte).</li> <li>• <b>Encapsulation Mode</b> Select <b>Transport</b> or <b>Tunnel</b>.</li> <li>• <b>Remote Router IP-Address</b> Type the IP address (IPv4 or IPv6) of the remote router. Enter this information only when the <b>Tunnel</b> mode is selected.</li> </ul> <hr/> <ul style="list-style-type: none"> <li>  <p>SA (Security Association) is an encrypted communication method using IPsec or IPv6 that exchanges and shares information, such as the encryption method and encryption key, in order to establish a secure communication channel before communication begins. SA may also refer to a virtual encrypted communication channel that has been established. The SA used for IPsec establishes the encryption method, exchanges the keys, and carries out mutual authentication according to the IKE (Internet Key Exchange) standard procedure. In addition, the SA is updated periodically.</p> </li> </ul>



## Related Information

- [Configure an IPsec Template Using Web Based Management](#)

## Send an Email Securely

- [Configure Email Sending Using Web Based Management](#)
- [Send an Email with User Authentication](#)
- [Send an Email Securely Using SSL/TLS](#)

## Configure Email Sending Using Web Based Management

We recommend using Web Based Management to configure secured email sending with user authentication.

1. Start your web browser.
2. Type "https://machine's IP address" in your browser's address bar (where "machine's IP address" is the machine's IP address).  
For example:  
https://192.168.1.2
3. If the machine prompts you for a password, type it, and then click .
4. Click the **Network** tab.
5. Click the **Protocol** menu in the left navigation bar.
6. In the **SMTP** field, click **Advanced Setting** and make sure the status of **SMTP** is **Enabled**.
7. Configure the **SMTP** settings.
  - Confirm that the email settings are correct after configuration by sending a test email.
  - If you do not know the SMTP server settings, contact your network administrator or Internet Service Provider (ISP).
8. When finished, click **Submit**.  
The **Test Send E-mail Configuration** dialog box appears.
9. Follow the instructions in the dialog box to test the current settings.

### Related Information

- [Send an Email Securely](#)

## Send an Email with User Authentication

Your Brother machine supports the SMTP-AUTH method to send email via an email server that requires user authentication. This method prevents unauthorised users from accessing the email server.

You can use the SMTP-AUTH method for email notification and email reports (available for certain models).



We recommend using Web Based Management to configure the SMTP authentication.

### Email Server Settings

You must configure your machine's SMTP authentication method to match the method used by your email server. For details about your email server settings, contact your network administrator or Internet Service Provider (ISP).



To enable SMTP server authentication: in the Web Based Management **SMTP** screen, under **Server Authentication Method**, you must select **SMTP-AUTH**.



### Related Information

- [Send an Email Securely](#)



## Send an Email Securely Using SSL/TLS

Your Brother machine supports SSL/TLS communication methods. To use email server that is using SSL/TLS communication, you must configure following settings.



We recommend using Web Based Management to configure SSL/TLS.

### Verify Server Certificate

Under **SSL/TLS**, if you choose **SSL** or **TLS**, the **Verify Server Certificate** check box will be selected automatically.



- Before you verify the server certificate, you must import the CA certificate issued by the CA that signed the server certificate. Contact your network administrator or your Internet Service Provider (ISP) to confirm if importing a CA certificate is necessary.
- If you do not need to verify the server certificate, clear the **Verify Server Certificate** check box.

### Port Number

If you select **SSL**, or **TLS**, the **Port** value will be changed to match the protocol. To change the port number manually, type the port number after you select **SSL/TLS** settings.

You must configure your machine's communication method to match the method used by your email server. For details about your email server settings, contact your network administrator or your ISP.

In most cases, the secured webmail services require the following settings:

SMTP	<b>Port</b>	25
	<b>Server Authentication Method</b>	<b>SMTP-AUTH</b>
	<b>SSL/TLS</b>	<b>TLS</b>



### Related Information

- [Send an Email Securely](#)

## Use IEEE 802.1x Authentication for a Wired or a Wireless Network

- [What Is IEEE 802.1x Authentication?](#)
- [Configure IEEE 802.1x Authentication for a Wired or a Wireless Network Using Web Based Management \(Web Browser\)](#)
- [IEEE 802.1x Authentication Methods](#)

## What Is IEEE 802.1x Authentication?

IEEE 802.1x is an IEEE standard for wired and wireless networks that limits access from unauthorised network devices. Your Brother machine (supplicant) sends an authentication request to a RADIUS server (Authentication server) through your access point or HUB. After your request has been verified by the RADIUS server, your machine can access the network.



### Related Information

- [Use IEEE 802.1x Authentication for a Wired or a Wireless Network](#)
-

## Configure IEEE 802.1x Authentication for a Wired or a Wireless Network Using Web Based Management (Web Browser)

- If you configure your machine using EAP-TLS authentication, you must install the client certificate issued by a CA before you start configuration. Contact your network administrator about the client certificate. If you have installed more than one certificate, we recommend writing down the certificate name you want to use.
- Before you verify the server certificate, you must import the CA certificate that has been issued by the CA that signed the server certificate. Contact your network administrator or your Internet Service Provider (ISP) to confirm whether a CA certificate import is necessary.



You can also configure IEEE 802.1x authentication using:

- BRAdmin Professional (Wired and wireless network)
- Wireless setup wizard from the control panel (Wireless network)
- Wireless setup wizard on the installation disc (Wireless network)

1. Start your web browser.
2. Type "https://machine's IP address" in your browser's address bar (where "machine's IP address" is the machine's IP address).

For example:

https://192.168.1.2



- If you are using a Domain Name System or enable a NetBIOS name, you can type another name, such as "SharedPrinter" instead of the IP address.

- For example:

https://SharedPrinter

If you enable a NetBIOS name, you can also use the node name.

- For example:

https://brnxxxxxxxxxxxx

The NetBIOS name can be found in the Network Configuration Report.

- For Mac, access Web Based Management by clicking the machine's icon on the **Status Monitor** screen.

3. If the machine prompts you for a password, type it, and then click .
4. Click the **Network** tab.
5. Do one of the following:

Option	Description
Wired network	Click the <b>Wired</b> tab, and then select <b>Wired 802.1x Authentication</b> in the left navigation bar.
Wireless network	Click the <b>Wireless</b> tab, and then select <b>Wireless (Enterprise)</b> in the left navigation bar.

6. Configure the IEEE 802.1x authentication settings.



- To enable IEEE 802.1x authentication for wired networks, select **Enabled** for **Wired 802.1x status** on the **Wired 802.1x Authentication** page.
- If you are using **EAP-TLS** authentication, you must select the client certificate that has been installed (shown with certificate name) for verification from the **Client Certificate** drop-down list.
- If you select **EAP-FAST**, **PEAP**, **EAP-TTLS**, or **EAP-TLS** authentication, select the verification method from the **Server Certificate Verification** drop-down list. Verify the server certificate using the CA certificate, imported to the machine in advance, that has been issued by the CA that signed the server certificate.

Select one of the following verification methods from the **Server Certificate Verification** drop-down list:

Option	Description
<b>No Verification</b>	The server certificate can always be trusted. The verification is not performed.
<b>CA Cert.</b>	The verification method to check the CA reliability of the server certificate, using the CA certificate that has been issued by the CA that signed the server certificate.
<b>CA Cert. + ServerID</b>	The verification method to check the common name <sup>1</sup> value of the server certificate, in addition to the CA reliability of the server certificate.

7. When finished with configuration, click **Submit**.

For wired networks: After configuring, connect your machine to the IEEE 802.1x supported network. After a few minutes, print the Network Configuration Report to check the **<Wired IEEE 802.1x>** Status.

Option	Description
<b>Success</b>	The wired IEEE 802.1x function is enabled and the authentication was successful.
<b>Failed</b>	The wired IEEE 802.1x function is enabled; however, the authentication failed.
<b>Off</b>	The wired IEEE 802.1x function is not available.



## Related Information

- [Use IEEE 802.1x Authentication for a Wired or a Wireless Network](#)

### Related Topics:

- [Print the Network Configuration Report](#)
- [Print the WLAN Report](#)
- [Supported Security Certificate Features](#)

<sup>1</sup> The common name verification compares the common name of the server certificate to the character string configured for the **Server ID**. Before you use this method, contact your system administrator about the server certificate's common name and then configure **Server ID**.

## IEEE 802.1x Authentication Methods

### LEAP (Wireless network)

Lightweight Extensible Authentication Protocol (LEAP) is a proprietary EAP method developed by Cisco Systems, Inc., which uses a user ID and password for authentication.

### EAP-FAST

Extensible Authentication Protocol-Flexible Authentication via Secured Tunneling (EAP-FAST) has been developed by Cisco Systems, Inc., which uses a user ID and password for authentication, and symmetric key algorithms to achieve a tunnelled authentication process.

The Brother machine supports the following inner authentication methods:

- EAP-FAST/NONE
- EAP-FAST/MS-CHAPv2
- EAP-FAST/GTC

### EAP-MD5 (Wired network)

Extensible Authentication Protocol-Message Digest Algorithm 5 (EAP-MD5) uses a user ID and password for challenge-response authentication.

### PEAP

Protected Extensible Authentication Protocol (PEAP) is a version of EAP method developed by Cisco Systems, Inc., Microsoft Corporation and RSA Security. PEAP creates an encrypted Secure Sockets Layer (SSL)/Transport Layer Security (TLS) tunnel between a client and an authentication server, for sending a user ID and password. PEAP provides mutual authentication between the server and the client.

The Brother machine supports the following inner authentications:

- PEAP/MS-CHAPv2
- PEAP/GTC

### EAP-TTLS

Extensible Authentication Protocol-Tunneled Transport Layer Security (EAP-TTLS) has been developed by Funk Software and Certicom. EAP-TTLS creates a similar encrypted SSL tunnel to PEAP, between a client and an authentication server, for sending a user ID and password. EAP-TTLS provides mutual authentication between the server and the client.

The Brother machine supports the following inner authentications:

- EAP-TTLS/CHAP
- EAP-TTLS/MS-CHAP
- EAP-TTLS/MS-CHAPv2
- EAP-TTLS/PAP

### EAP-TLS

Extensible Authentication Protocol-Transport Layer Security (EAP-TLS) requires digital certificate authentication both at a client and an authentication server.



### Related Information

- [Use IEEE 802.1x Authentication for a Wired or a Wireless Network](#)

## Mobile/Web Connect

- [Brother Web Connect](#)
- [Google Cloud Print](#)
- [AirPrint](#)
- [Mobile Printing for Windows](#)
- [Mopria® Print Service](#)
- [Brother iPrint&Scan for Mobile Devices](#)
- [Near-Field Communication \(NFC\)](#)

## Brother Web Connect

- [Brother Web Connect Overview](#)
- [Online Services Used with Brother Web Connect](#)
- [Conditions for Using Brother Web Connect](#)
- [Set Up Brother Web Connect](#)
- [Scan and Upload Documents Using Brother Web Connect](#)
- [Upload a Document from an External Memory Device Using Brother Web Connect](#)
- [Download and Print Documents Using Brother Web Connect](#)
- [Download and Save a Document to an External Memory Device Using Brother Web Connect](#)
- [FaxForward to Cloud or E-mail](#)



## Brother Web Connect Overview

Certain websites provide services that allow users to upload and view images and files on the website. Your Brother machine can scan images and upload them to these services, and also download from and print images that are already uploaded to these services.

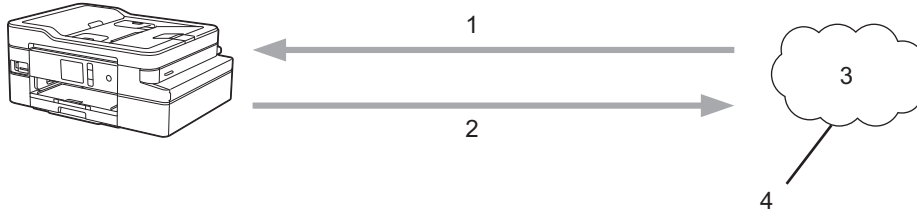



1. Printing
2. Scanning
3. Photos, images, documents and other files
4. Web Service

To use Brother Web Connect, your Brother machine must be connected to a network that has access to the Internet, through either a wired or wireless connection.

For network setups that use a proxy server, the machine must also be configured to use a proxy server. If you are unsure of your network configuration, check with your network administrator.



A proxy server is a computer that serves as an intermediary between computers without a direct Internet connection, and the Internet.

Press  (Web) or  (Apps) on the touchscreen to use Brother Web Connect.

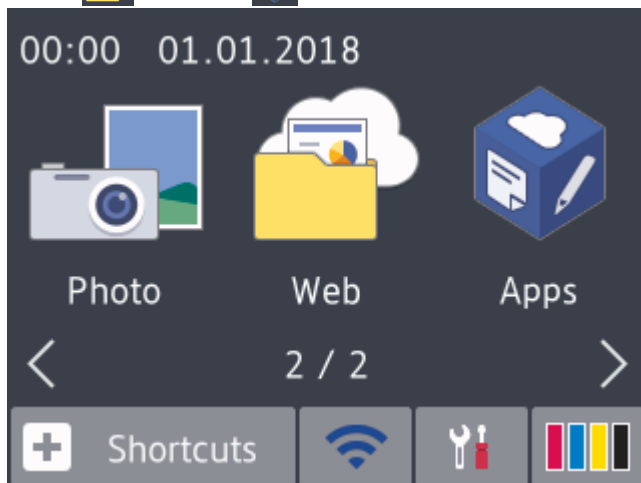

### ✓ Related Information

- [Brother Web Connect](#)

## Online Services Used with Brother Web Connect

Use Brother Web Connect to access online services from your Brother machine. Some of these web services offer business versions.

To use Brother Web Connect, you must have an account with the online service you want to use. If you do not already have an account, use a computer to access the service's website and create an account.

You do not need to create an account to use Brother Creative Center. (Brother CreativeCenter is available only for some models.)

### Google Drive™

An online document storage, editing, sharing and file synchronisation service.

URL: [drive.google.com](http://drive.google.com)

### Evernote®

An online file storage and management service.

URL: [www.evernote.com](http://www.evernote.com)

### Dropbox

An online file storage, sharing and synchronisation service.

URL: [www.dropbox.com](http://www.dropbox.com)

### OneDrive

An online file storage, sharing and management service.

URL: <https://onedrive.live.com>

### Box

An online document editing and sharing service.

URL: [www.box.com](http://www.box.com)

### OneNote

An online document editing and sharing service.

URL: [www.onenote.com](http://www.onenote.com)

### Brother Creative Center

A website that offers various templates, such as greeting cards, brochures and calendars that you can print on your Brother machine. (available only for certain countries and models)

[www.brother.com/creativecenter](http://www.brother.com/creativecenter)

For more information about any of these services, refer to the respective service's website.

The following table describes which file types can be used with each Brother Web Connect feature:

Accessible Services	Google Drive™ Evernote® Dropbox OneDrive Box	OneNote	Brother Creative Center
Download and print images or save them to media	JPEG PDF DOC DOCX XLS XLSX PPT	JPEG PDF DOC DOCX XLS XLSX PPT PPTX	(Print only)

Accessible Services	Google Drive™ Evernote® Dropbox OneDrive Box	OneNote	Brother Creative Center
	PPTX		
Upload scanned images	JPEG PDF DOCX XLSX PPTX TIFF	JPEG PDF DOCX XLSX PPTX TIFF	-
Upload images saved on media	JPEG	-	-
FaxForward to the online services (MFC-J1300DW)	JPEG PDF TIFF	JPEG PDF TIFF	-



- Not all services are available in all countries.
- For Hong Kong, Taiwan and Korea

Brother Web Connect supports only file names written in English. Files named in the local language will not be downloaded.



## Related Information

- [Brother Web Connect](#)

## Conditions for Using Brother Web Connect

- [Brother Software Installation for Using Brother Web Connect](#)
- [Configure the Proxy Server Settings Using the Machine's Control Panel](#)
- [Configure the Proxy Server Settings Using Web Based Management](#)

## Brother Software Installation for Using Brother Web Connect

The initial installation of Brother Web Connect requires a computer that has access to the Internet and has the Brother machine's software installed.

### Windows

To install the Brother software and connect your machine to a wireless or wired network, see the *Quick Setup Guide*.

### Mac

To install the **Full Driver & Software Package**, go to your model's **Downloads** page on the Brother Solutions Center at [support.brother.com](http://support.brother.com).





### Related Information

- [Conditions for Using Brother Web Connect](#)
-

## Configure the Proxy Server Settings Using the Machine's Control Panel

If your network uses a proxy server, the following proxy server information must be configured on the machine:

- Proxy server address
- Port number
- User Name
- Password

1. Press  [Settings] > [All Settings] > [Network] > [Web Connect Settings] > [Proxy Settings] > [Proxy Connection].
2. Press [On].
3. Press the option that you want to set, and then enter the proxy server information.  
Press [OK].
4. Press .

### Related Information

- [Conditions for Using Brother Web Connect](#)

## Configure the Proxy Server Settings Using Web Based Management

If your network uses a proxy server, the following proxy server information must be configured using Web Based Management:

- Proxy server address
- Port number
- User Name
- Password



We recommend Microsoft Internet Explorer 11/Microsoft Edge for Windows, and Safari 10/11 for Mac. Make sure that JavaScript and Cookies are always enabled in whichever browser you use.

1. Start your web browser.
2. Type "https://machine's IP address" in your browser's address bar (where "machine's IP address" is the machine's IP address).  
For example:  
https://192.168.1.2
3. If the machine prompts you for a password, type it, and then click .
4. Click the **Network** tab.
5. Click the **Protocol** menu in the left navigation bar.
6. Make sure the **Proxy** check box is selected, and then click **Submit**.
7. In the **Proxy** field, click **Advanced Settings**.
8. Enter the proxy server information.
9. Click **Submit**.



### Related Information

- [Conditions for Using Brother Web Connect](#)

## Set Up Brother Web Connect

- [Brother Web Connect Setup Overview](#)
- [Create an Account for Each Online Service Before Using Brother Web Connect](#)
- [Apply for Brother Web Connect Access](#)
- [Register an Account on Your Brother Machine for Brother Web Connect](#)
- [Set Up Brother Web Connect for Brother CreativeCenter](#)



## Brother Web Connect Setup Overview

Configure the Brother Web Connect settings using the following procedure (when using Brother CreativeCenter, this procedure is not necessary):

### Step 1: Create an account with the service you want to use.

Access the service's website using a computer and create an account. (If you already have an account, there is no need to create an additional account.)

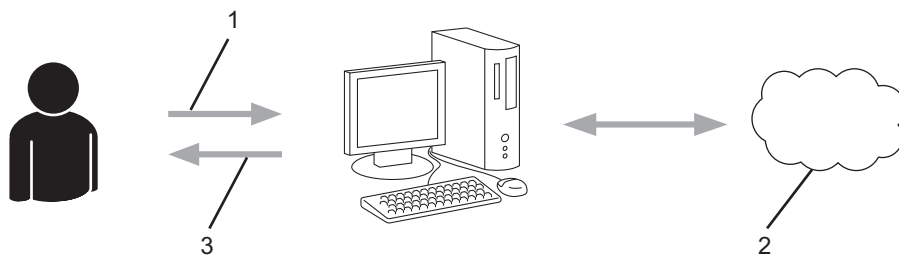

1. User registration
2. Web Service
3. Obtain account

### Step 2: Apply for Brother Web Connect access.

Start Brother Web Connect access using a computer and obtain a temporary ID.

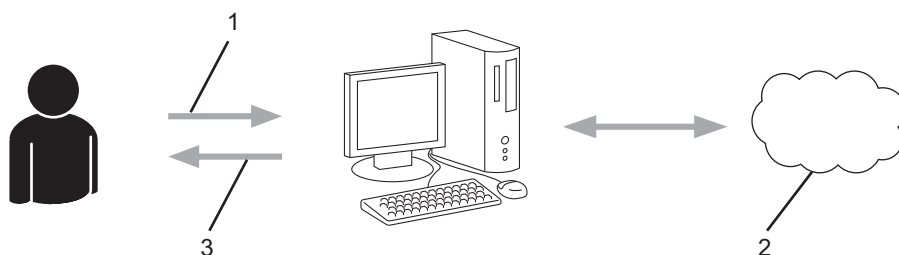

1. Enter account information
2. Brother Web Connect application page
3. Obtain temporary ID

### Step 3: Register your account information on your machine so you can access the service you want to use.

Enter the temporary ID to enable the service on your machine. Specify the account name as you would like it to be displayed on the machine, and enter a PIN if you would like to use one.

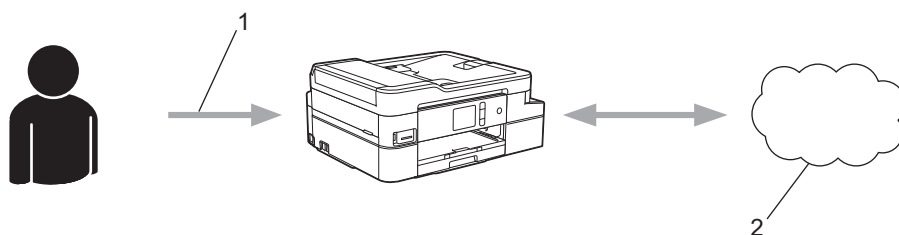

1. Enter temporary ID
2. Web Service

Your Brother machine can now use the service.



## Related Information

- [Set Up Brother Web Connect](#)
-

## Create an Account for Each Online Service Before Using Brother Web Connect

To use Brother Web Connect to access an online service, you must have an account with that online service. If you do not already have an account, use a computer to access the service's website and create an account. After creating an account, log on and use the account once with a computer before using the Brother Web Connect feature. Otherwise, you may not be able to access the service using Brother Web Connect.

If you already have an account, there is no need to create an additional account.

After you finish creating an account with the online service you want to use, apply for Brother Web Connect access.







### Related Information

- [Set Up Brother Web Connect](#)
-

## Apply for Brother Web Connect Access

To use Brother Web Connect to access online services, you must first apply for Brother Web Connect access using a computer that has the Brother Software installed.

1. Access the Brother Web Connect application website:

Option	Description
Windows 7	Click  ( <b>Start</b> ) > <b>All Programs</b> > <b>Brother</b> > <b>Brother Utilities</b> , and then click the drop-down list and select your model name (if not already selected). Click <b>Do More</b> in the left navigation bar, and then click <b>Brother Web Connect</b> .
Windows 8 Windows 10	Launch  ( <b>Brother Utilities</b> ), and then click the drop-down list and select your model name (if not already selected). Click <b>Do More</b> in the left navigation bar, and then click <b>Brother Web Connect</b> .
Windows 8.1	Move your mouse to the lower left corner of the <b>Start</b> screen and click  (if you are using a touch-based device, swipe up from the bottom of the <b>Start</b> screen to bring up the <b>Apps</b> screen).  Click  ( <b>Brother Utilities</b> ), and then click the drop-down list and select your model name (if not already selected). Click <b>Do More</b> in the left navigation bar, and then click <b>Brother Web Connect</b> .
Mac	Click <b>Go</b> in the <b>Finder</b> bar, <b>Applications</b> > <b>Brother</b> > <b>Utilities</b> > <b>Brother Web Connect</b> .



You can also access the website directly:

Type [bwc.brother.com](http://bwc.brother.com) into your web browser's address bar.

The Brother Web Connect page launches.

2. Select the service you want to use.

### Get connected with Brother Web Connect

Click on one of the following services to be used on your machine to obtain a temporary ID. Business versions of the web services are also supported including: OneDrive for business, Dropbox for business, Google apps for work, Evernote business and Box for business.



OneNote



OneDrive



Box



Connect to Google Drive™



EVERNOTE



Dropbox

The actual screen may differ from the screen shown above.

3. Follow the on-screen instructions and apply for access.

When finished, your temporary ID will appear.

## Get connected with Brother Web Connect

Finished the registration.

Please enter the following temporary ID on the LCD screen of your machine.

Temporary ID (11 digits)

**XXX XXXX XXXX**

NOTE : The temporary ID will expire in 24 hours.

4. Make a note of your temporary ID, as you will need it to register accounts to the machine. The temporary ID is valid for 24 hours.
5. Close the web browser.

Now that you have a Brother Web Connect access ID, you must register this ID on your machine, and then use your machine to access the web service you want to use.



### Related Information

- [Set Up Brother Web Connect](#)

## Register an Account on Your Brother Machine for Brother Web Connect

You must enter your Brother Web Connect account information and configure your machine so that it can use Brother Web Connect to access the service you want.

- You must apply for Brother Web Connect access to register an account on your machine.
- Before you register an account, confirm that the correct date and time are set on the machine's control panel.

1. Press ◀ or ▶ to display [Web].

Press [Web].



- If information regarding the Internet connection appears on the machine's LCD, read the information and press [OK].
- Occasionally, updates or announcements about Brother Web Connect's features will appear on the LCD. Read the information, and then press [OK].

2. Press ▲ or ▼ to display the service with which you want to register.

Press the service name.

3. If information regarding Brother Web Connect appears, press [OK].

4. Press [Register/Delete] > [Register Account].

5. The machine will prompt you to enter the temporary ID you received when you applied for Brother Web Connect access.

Press [OK].

6. Enter the temporary ID using the LCD, and then press [OK].



An error message will appear on the LCD if the information you entered does not match the temporary ID you received when you applied for access, or if the temporary ID has expired. Either enter the temporary ID correctly, or apply for access again and receive a new temporary ID.

7. The machine will prompt you to enter the account name that you want to be displayed on the LCD.

Press [OK].

8. Enter the name using the LCD, and then press [OK].

9. Do one of the following:

- To set a PIN for the account, press [Yes]. (A PIN prevents unauthorised access to the account.) Enter a four-digit number, and then press [OK].
- If you do not want to set a PIN, press [No].



When the account information you entered appears, confirm that it is correct.

10. Press [Yes] to register your information as entered.

11. Press [OK].

Account registration is complete and your machine can now access the service.

12. Press .



### Related Information

- [Set Up Brother Web Connect](#)

## Set Up Brother Web Connect for Brother CreativeCenter

Brother Web Connect is set up to work with Brother CreativeCenter automatically. No configuration is needed to create the calendars, business cards, posters and greeting cards available at [www.brother.com/creativecenter](http://www.brother.com/creativecenter).



Brother CreativeCenter is not available in all countries.



### Related Information

- [Set Up Brother Web Connect](#)

## Scan and Upload Documents Using Brother Web Connect

Upload your scanned photos and documents directly to a web service without using a computer.

- When scanning and uploading JPEG files, monochrome scanning is not available.
- When scanning and uploading searchable PDF or Microsoft Office files, monochrome and grey scanning is not available.
- When scanning and uploading JPEG files, each page is uploaded as a separate file.
- Uploaded documents are saved in an album named **From\_BrotherDevice**.

For information regarding restrictions, such as the size or number of documents that can be uploaded, refer to the respective service's website.

If you are a restricted Web Connect user due to the Secure Function Lock feature (available for certain models), you cannot upload the scanned data.

1. Load your document.
2. Press ◀ or ▶ to display [Web].

Press [Web].



- You can also press [Scan] > [to Web].
- If information regarding the Internet connection appears on the machine's LCD, read the information and press [OK].
- Occasionally, updates or announcements about Brother Web Connect's features will appear on the LCD. Read the information, and then press [OK].

3. Press ▲ or ▼ to display the service that hosts the account to which you want to upload.  
Press the service name.

4. Press ▲ or ▼ to display your account name, and then press it.
5. If the PIN entry screen appears, enter the four-digit PIN and press [OK].
6. Press ▲ or ▼ to display [Upload: Scanner].

Press [Upload: Scanner].



- If you pressed [Scan] > [to Web], this option does not appear.
- This option may not appear depending on the service.

7. Follow the on-screen instructions to complete this operation.



### Related Information

- [Brother Web Connect](#)



## Upload a Document from an External Memory Device Using Brother Web Connect

Documents saved on media (such as a memory card or a USB flash drive) connected to the machine can be uploaded directly to a web service.

- Uploaded documents are saved in an album named **From\_BrotherDevice**.
- USB flash drive is available only for some models.

For information regarding restrictions, such as the size or number of documents that can be uploaded, refer to the respective service's website.

If you are a restricted Web Connect user due to the Secure Function Lock feature (available for certain models), you cannot upload documents saved on media.

### IMPORTANT

DO NOT remove the memory card or USB flash drive while your Brother machine is accessing the media. Otherwise, the card, USB flash drive, or data stored on the card could be damaged.



(For Hong Kong, Taiwan and Korea)

Brother Web Connect supports only file names written in English. Files named in the local language will not be uploaded.

1. Insert a memory card or USB flash drive into your machine.

The LCD automatically changes.

2. Press [Web].



- If information regarding the Internet connection appears on the machine's LCD, read the information and press [OK].
- Occasionally, updates or announcements about Brother Web Connect's features will appear on the LCD. Read the information, and then press [OK].

3. Press ▲ or ▼ to display the service that hosts the account to which you want to upload.

Press the service name.

4. Press ▲ or ▼ to display your account name, and then press it.

5. If the PIN entry screen appears, enter the four-digit PIN and press [OK].

6. Press ▲ or ▼ to display [Upload: Media].

Press [Upload: Media].

7. Follow the on-screen instructions to complete this operation.



### Related Information

- [Brother Web Connect](#)

## Download and Print Documents Using Brother Web Connect

Documents that have been uploaded to your account can be downloaded directly to your machine and printed. Documents that other users have uploaded to their own accounts for sharing can also be downloaded to your machine and printed, as long as you have viewing privileges for those documents. Certain services allow guest users to view documents that are public. When accessing a service or an account as a guest user, you can view documents that the owner has made public, that is, documents with no viewing restrictions.

To download other users' documents, you must have access privileges to view the corresponding albums or documents.

If you are a restricted user for Web Connect due to the Secure Function Lock feature (available for certain models), you cannot download the data.

The Secure Function Lock Page Limit feature applies to the print job using Web Connect.



For Hong Kong, Taiwan and Korea

Brother Web Connect supports only file names written in English. Files named in the local language will not be downloaded.



### Related Information

- [Brother Web Connect](#)
  - [Download and Print Using Web Services](#)
  - [Download and Print Brother CreativeCenter Templates](#)

## Download and Print Using Web Services

For information on Brother CreativeCenter Templates, see *Related Information*.

1. Press ◀ or ▶ to display [Web].

Press [Web].



- If information regarding the Internet connection appears on the machine's LCD, read the information and press [OK].
- Occasionally, updates or announcements about Brother Web Connect's features will appear on the LCD. Read the information, and then press [OK].

2. Press ▲ or ▼ to display the service that hosts the document you want to download and print.

Press the service name.

3. Press ▲ or ▼ to display your account name, and then press it. If the PIN entry screen appears, enter the four-digit PIN and press [OK].

4. Press ▲ or ▼ to display [Download: Print].

Press [Download: Print].

5. Press ▲ or ▼ to display the desired album, and then press it.



- An album is a collection of documents. However, the actual term may differ depending on the service you use. When using Evernote®, you must select the notebook, and then select the note.
- Some services do not require documents to be saved in albums. For documents not saved in albums, select [See Unsorted Files] to select documents. You cannot download documents from other users if the documents are not saved in an album.

6. Press the thumbnail of the document you want to print. Confirm the document on the LCD and press [OK]. Select additional documents to print (you can select up to 10 documents).

7. When finished, press [OK].

8. Follow the on-screen instructions to complete this operation.



### Related Information

- [Download and Print Documents Using Brother Web Connect](#)

#### Related Topics:

- [Download and Print Brother CreativeCenter Templates](#)

## Download and Print Brother CreativeCenter Templates

Brother CreativeCenter is not available in all countries.

1. Press ◀ or ▶ to display [Apps].

Press [Apps].



- If information regarding the Internet connection appears on the machine's LCD, read it, and then press [OK].
- Occasionally, updates or announcements about Brother Web Connect's features will appear on the LCD. Read the information, and then press [OK].

2. Press ▲ or ▼ to display [Print "CreativeCenter" Templates].

Press [Print "CreativeCenter" Templates].

3. Press ▲ or ▼ to display the desired category, and then press it.
4. Select the desired file. Enter the number of copies you want to print and then press [OK]. Repeat this step until you have selected all the files that you want to print.
5. When finished, press [OK].



If information regarding the recommended print settings appears on the machine's LCD, read the information and press [OK].

6. Follow the on-screen instructions to complete this operation.



### Related Information

- [Download and Print Documents Using Brother Web Connect](#)

#### Related Topics:

- [Download and Print Using Web Services](#)

## Download and Save a Document to an External Memory Device Using Brother Web Connect

JPEG, PDF and Microsoft Office files can be downloaded from a service and saved directly on media connected to the machine. Documents that other users have uploaded to their own accounts for sharing can also be downloaded to your machine as long as you have viewing privileges for those documents. Certain services allow guest users to view documents that are public. When accessing a service or an account as a guest user, you can view documents that the owner has made public, that is, documents with no viewing restrictions.

- Make sure there is enough available space on your memory card or USB flash drive.
- To download other users' documents, you must have access privileges to view the corresponding albums or documents.
- USB flash drive is available only for some models.
- Downloaded files are renamed based on the current date. For example, the first image saved on July 1, would be named 07010001.jpg. Note that the region setting also determines the date format of the file name.
- Images are saved in the "BROTHER" folder, which can be found on the root level of the media.

### IMPORTANT

DO NOT remove the memory card or USB flash drive while your Brother machine is accessing the media. Otherwise, the card, USB flash drive, or data stored on the card could be damaged.

1. Insert a memory card or USB flash drive into your machine.

The LCD automatically changes.

2. Press [Web].



- If information regarding the Internet connection appears on the machine's LCD, read the information and press [OK].
- Occasionally, updates or announcements about Brother Web Connect's features will appear on the LCD. Read the information, and then press [OK].

3. Press ▲ or ▼ to display the service that hosts the document you want to download.

Press the service name.

4. Press ▲ or ▼ to display your account name, and then press it. If the PIN entry screen appears, enter the four-digit PIN and press [OK].

5. Press ▲ or ▼ to display [Download: Media].

Press [Download: Media].

6. Follow the on-screen instructions to complete this operation.



- An album is a collection of documents. However, the actual term may differ depending on the service you use. When using Evernote®, you must select the notebook, and then select the note.
- Some services do not require documents to be saved in albums. For documents not saved in albums, select [See Unsorted Files] to select documents. You cannot download documents from other users if the documents are not saved in an album.



### Related Information

- [Brother Web Connect](#)

## FaxForward to Cloud or E-mail

Related Models: MFC-J1300DW

- Use the FaxForward to Cloud feature to automatically forward incoming faxes to your accounts with the available online services.

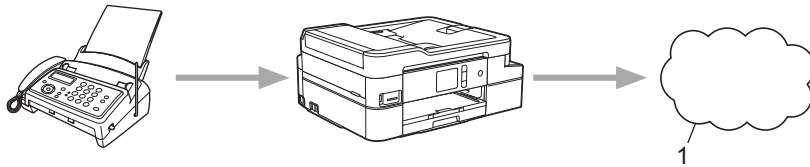

### 1. Web Service

- Use the FaxForward to E-mail feature to automatically forward incoming faxes to an inbox as email attachments.

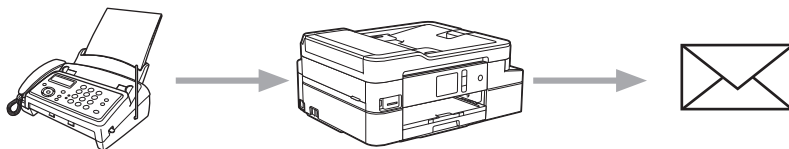

### ✓ Related Information

- [Brother Web Connect](#)
  - [Turn On FaxForward to Cloud or E-mail](#)
  - [Turn Off FaxForward to Cloud or E-mail](#)

## Turn On FaxForward to Cloud or E-mail

**Related Models:** MFC-J1300DW

Turn on the FaxForward feature to automatically forward incoming faxes to either an online service or an inbox as email attachments.

- This feature is available only for monochrome faxes.
- If you turn on FaxForward, you cannot use the following features:
  - [Fax Forward]
  - [Fax Storage]
  - [PC Fax Receive]

1. Press ◀ or ▶ to display [Apps].

Press [Apps].



- If information regarding the Internet connection appears on the machine's LCD, read it, and then press [OK].
- Occasionally, updates or announcements about Brother Web Connect's features will appear on the LCD. Read the information, and then press [OK].

2. Press ▲ or ▼ to display [FaxForward to Cloud/E-mail].

Press [FaxForward to Cloud/E-mail].



If information regarding [FaxForward to Cloud/E-mail] appears, read it, and then press [OK].

3. Press [On].

4. Press [Forward to Cloud] or [Forward to E-mail].

- If you selected [Forward to Cloud], choose the online service you want to receive the faxes, and then specify your account name.
- If you selected [Forward to E-mail], select the email address you want to receive the faxes as email attachments.

5. Follow the on-screen instructions to complete this operation.



### Related Information

- [FaxForward to Cloud or E-mail](#)

#### Related Topics:

- [Memory Receive Options](#)

## Turn Off FaxForward to Cloud or E-mail

**Related Models:** MFC-J1300DW

Turn off FaxForward when you want to stop incoming faxes from automatically going to either an online service or an inbox as email attachments.

If there are received faxes still in your machine's memory, you cannot turn off FaxForward.

1. Press ◀ or ▶ to display [Apps].

Press [Apps].



- If information regarding the Internet connection appears on the machine's LCD, read it, and then press [OK].
- Occasionally, updates or announcements about Brother Web Connect's features will appear on the LCD. Read the information, and then press [OK].

2. Press ▲ or ▼ to display [FaxForward to Cloud/E-mail].

Press [FaxForward to Cloud/E-mail].



If information regarding [FaxForward to Cloud/E-mail] appears, read it, and then press [OK].

3. Press [Off].
4. Press [OK].



### Related Information

- [FaxForward to Cloud or E-mail](#)



## Google Cloud Print

- [Google Cloud Print Overview](#)
- [Before Using Google Cloud Print](#)
- [Print from Google Chrome™ or Chrome OS™](#)
- [Print from Google Drive™ for Mobile](#)
- [Print from Gmail™ Webmail Service for Mobile](#)

## Google Cloud Print Overview

Google Cloud Print™ is a Google service that allows you to print to a printer registered to your Google account using a network-compatible device (such as a mobile phone or computer) without installing the printer driver on the device.

Printing from Android™ apps requires installing the Google Cloud Print™ app from the Google Play™ Store.

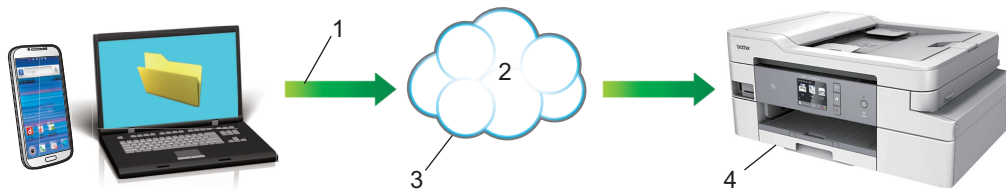

1. Print request
2. Internet
3. Google Cloud Print™
4. Printing



### Related Information

- [Google Cloud Print](#)

## Before Using Google Cloud Print

- [Network Settings for Using Google Cloud Print](#)
- [Register Your Machine with Google Cloud Print Using Google Chrome™](#)
- [Register Your Machine with Google Cloud Print Using Web Based Management](#)

## Network Settings for Using Google Cloud Print

In order to use Google Cloud Print™, your Brother machine must be connected to a network that has access to the Internet, either through a wired or wireless connection. To connect and configure your machine correctly, see the *Quick Setup Guide* or related topics in this guide.



### Related Information

- [Before Using Google Cloud Print](#)
-

## Register Your Machine with Google Cloud Print Using Google Chrome™

Make sure you have already created a Google Account. If you do not have an account, use a computer or mobile device to access the Google website (<https://accounts.google.com/signup>) and create an account. Make sure your Brother machine is idle before starting the registration process.



The steps in this section are examples for Windows users.

Screens on your computer may vary depending on your operating system and environment.

1. Open Google Chrome™ on your computer.
2. Sign in to your Google Account.
3. Click the Google Chrome™ menu icon, and then **Settings > Show advanced settings....**
4. Click **Google Cloud Print > Manage**.
5. Follow the on-screen instructions to register your machine.
6. When a confirmation message appears on your machine, press the [OK] button.



If the confirmation message does not appear on your machine's LCD, repeat these steps.

7. When your Brother machine is successfully registered, it will appear in the **My devices** field.



### Related Information

- [Before Using Google Cloud Print](#)

## Register Your Machine with Google Cloud Print Using Web Based Management

Make sure you have already created a Google Account. If you do not have an account, use a computer or mobile device to access the Google website (<https://accounts.google.com/signup>) and create an account.

Make sure your Brother machine is idle before starting the registration process.

Before you begin to register your machine, confirm that the correct date and time are set on the machine's control panel. See *Related Information*.

1. Confirm that your Brother machine is connected to the same network as your computer or mobile device.
2. Start your web browser.  
Type "https://machine's IP address" in your browser's address bar (where "machine's IP address" is the IP address of the machine or the print server name). For example: https://192.168.1.2  
If the machine prompts you for a password, type it, and then click .
3. Click the **Network** tab.
4. Click the **Protocol** menu in the left navigation bar.
5. Make sure that **Google Cloud Print** is selected, and then click **Advanced Settings**.
6. Make sure that **Status** is set to **Enabled**. Click **Register**.
7. When a confirmation message appears on your machine's LCD, press [OK].



If the confirmation message does not appear on your machine's LCD, repeat these steps.

8. Click **Google**.
9. The sign-in screen for Google Cloud Print™ appears. Sign in with your Google Account and follow the on-screen instructions to register your machine.
10. When you have finished registering your machine, return to the Web Based Management screen and make sure that **Registration Status** is set to **Registered**.



If your machine supports the Secure Function Lock feature, printing via Google Cloud Print™ is possible even if PC print for each user is restricted. To restrict printing via Google Cloud Print™, disable Google Cloud Print™ using Web Based Management or set the Secure Function Lock feature to Public Mode, and then restrict print for public users. See *Related Information*.



### Related Information

- [Before Using Google Cloud Print](#)

#### Related Topics:

- [Set the Date and Time](#)
- [Configure Secure Function Lock 3.0 Using Web Based Management](#)

## Print from Google Chrome™ or Chrome OS™

1. Make sure your Brother machine is turned on.
2. Open the web page that you want to print.
3. Click the Google Chrome™ menu icon.
4. Click **Print**.
5. Select your machine from the printer list.
6. Change print options, if needed.
7. Click **Print**.



### Related Information

- [Google Cloud Print](#)
-

## Print from Google Drive™ for Mobile

1. Make sure your Brother machine is turned on.
2. Access Google Drive™ from your Android™ or iOS device's web browser.
3. Open the document that you want to print.
4. Tap the menu icon.
5. Tap **Print**.
6. Select your machine from the printer list.
7. Change print options, if needed.
8. Tap  or **Print**.



### Related Information

- [Google Cloud Print](#)



## Print from Gmail™ Webmail Service for Mobile

1. Make sure your Brother machine is turned on.
2. Access the Gmail™ webmail service from your Android™ or iOS device's web browser.
3. Open the email that you want to print.
4. Tap the menu icon.



If **Print** appears beside the attachment name, you can also print the attachment. Tap **Print**, and then follow the instructions on your mobile device.

5. Tap **Print**.
6. Select your machine from the printer list.
7. Change print options, if needed.
8. Tap  or **Print**.



### Related Information

- [Google Cloud Print](#)

## AirPrint

- [AirPrint Overview](#)
- [Before Using AirPrint \(macOS\)](#)
- [Print Using AirPrint](#)
- [Scan Using AirPrint \(macOS\)](#)
- [Send a Fax Using AirPrint \(macOS\)](#)

## AirPrint Overview

AirPrint is a printing solution for Apple operating systems that allows you to wirelessly print photos, email, web pages and documents from your iPad, iPhone, iPod touch and Mac computer without the need to install a driver.

AirPrint also lets you send faxes directly from your Mac computer without printing them and lets you scan documents to your Mac computer. (MFC-J1300DW)

For more information, visit Apple's website.

Use of the "Works with Apple badge" means that an accessory has been designed to work specifically with the technology identified in the badge and has been certified by the developer to meet Apple performance standards.



### Related Information

- [AirPrint](#)

## Before Using AirPrint (macOS)

Before printing using macOS, add your Brother machine to the printer list on your Mac computer.

1. Select **System Preferences** from the Apple menu.
2. Click **Printers & Scanners**.
3. Click the + icon below the Printers pane on the left.  
The **Add** screen appears.
4. Select your Brother machine, and then select **AirPrint** from the **Use** pop-up menu.
5. Click **Add**.



### Related Information



- [AirPrint](#)
-

## Print Using AirPrint

- [Print from iPad, iPhone, or iPod touch](#)
- [Print Using AirPrint \(macOS\)](#)

## Print from iPad, iPhone, or iPod touch

The procedure used to print may vary by application. Safari is used in the example below.

1. Make sure your Brother machine is turned on.
2. Use Safari to open the page that you want to print.
3. Tap  or .
4. Tap **Print**.
5. Make sure your Brother machine is selected.
6. If a different machine (or no printer) is selected, tap **Printer**.  
A list of available machines appears.
7. Tap your machine's name in the list.
8. Select the desired options, such as the number of pages to print and 2-sided printing (if supported by your machine).
9. Tap **Print**.



### Related Information

- [Print Using AirPrint](#)

## Print Using AirPrint (macOS)

The procedure used to print may vary by application. Safari is used in the example below. Before printing, make sure your Brother machine is in the printer list on your Mac computer.

1. Make sure your Brother machine is turned on.
2. On your Mac computer, use Safari to open the page that you want to print.
3. Click the **File** menu, and then select **Print**.
4. Make sure your Brother machine is selected. If a different machine (or no printer) is selected, click the **Printer** pop-up menu, and then select your Brother machine.
5. Select the desired options, such as the number of pages to print and 2-sided printing (if supported by your machine).
6. Click **Print**.

### Related Information

- [Print Using AirPrint](#)

#### **Related Topics:**

- [Before Using AirPrint \(macOS\)](#)

## Scan Using AirPrint (macOS)

Before scanning, make sure your Brother machine is in the scanner list on your Mac computer.

1. Load your document.
2. Select **System Preferences** from the Apple menu.
3. Click **Printers & Scanners**.
4. Select your Brother machine from the scanner list.
5. Click the **Scan** tab, and then click the **Open Scanner...** button.  
The Scanner screen appears.
6. If you place the document in the ADF, select **Use Document Feeder** check box, and then select the size of your document from the scan size setting pop-up menu.
7. Select the destination folder or destination application from the destination setting pop-up menu.
8. Click **Show Details** to change the scanning settings if needed.  
You can crop the image manually by dragging the mouse pointer over the portion you want to scan when scanning from the scanner glass.
9. Click **Scan**.



### Related Information

- [AirPrint](#)

#### Related Topics:

- [Before Using AirPrint \(macOS\)](#)



## Send a Fax Using AirPrint (macOS)

**Related Models:** MFC-J1300DW

Make sure your Brother machine is in the printer list on your Mac computer. Apple TextEdit is used in the example below.



- AirPrint supports only monochrome fax documents.
- Your machine supports the Secure Function Lock feature. Sending faxes via AirPrint is not available if Fax Tx for each user is restricted.

1. Make sure your Brother machine is turned on.
2. On your Mac computer, open the file that you want to send as a fax.
3. Click the **File** menu, and then select **Print**.
4. Click the **Printer** pop-up menu, and then select **Brother MFC-XXXX - Fax** (where XXXX is your model name).
5. Type the fax recipient information.
6. Click **Fax**.



### Related Information

- [AirPrint](#)

#### Related Topics:

- [Before Using AirPrint \(macOS\)](#)

## Mobile Printing for Windows

Mobile printing for Windows is a function to print wirelessly from your Windows mobile device. You can connect to the same network that your Brother machine is connected to and print without installing the printer driver on the device. Many Windows apps support this function.



1. Windows mobile device (Windows 10 Mobile or later)
2. Wi-Fi® connection
3. Your Brother machine

### Related Information

- [Mobile/Web Connect](#)

## Mopria® Print Service

Mopria® Print Service is a print feature on Android™ mobile devices (Android™ version 4.4 or later) developed by the Mopria® Alliance. With this service, you can connect to the same network as your machine and print without additional setup. Many native Android™ apps support printing.



1. Android™ 4.4 or later
2. Wi-Fi® Connection
3. Your Brother Machine

You must download the Mopria® Print Service from the Google Play™ Store and install it on your Android™ device. Before using this service, you must turn it on.



### Related Information

- [Mobile/Web Connect](#)

## Brother iPrint&Scan for Mobile Devices

Use Brother iPrint&Scan to print and scan from various mobile devices.

- For Android™ Devices

Brother iPrint&Scan allows you to use features of your Brother machine directly from your Android™ device, without using a computer.

Download and install Brother iPrint&Scan from the Google Play™ Store app.

- For all iOS supported devices including iPhone, iPad and iPod touch

Brother iPrint&Scan allows you to use features of your Brother machine directly from your iOS device.

Download and install Brother iPrint&Scan from the App Store.

- For Windows Devices

Brother iPrint&Scan allows you to use features of your Brother machine directly from your Windows device, without using a computer.

Download and install Brother iPrint&Scan from the Microsoft Store.

For more detailed information, visit [support.brother.com/ips](http://support.brother.com/ips).



### Related Information

- [Mobile/Web Connect](#)

#### Related Topics:

- [Brother iPrint&Scan for Windows and Mac](#)

## Near-Field Communication (NFC)

**Related Models:** MFC-J1300DW

Near-Field Communication (NFC) allows for simple transactions, data exchange and wireless connections between two devices that are close to each other.

If your Android™ device is NFC-enabled, you can print data (photos, PDF files, text files, web pages and email messages) from the device or scan photos and documents to the device by touching it to the NFC symbol on the machine's control panel.

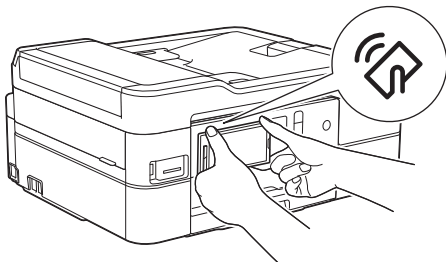

You must download and install Brother iPrint&Scan to your Android™ device to use this feature.

### ✓ Related Information

- [Mobile/Web Connect](#)

#### Related Topics:

- [Control Panel Overview](#)

## ControlCenter

Use Brother's ControlCenter software utility to quickly access your frequently-used applications. Using ControlCenter gives you direct access to specific applications.

- [ControlCenter4 \(Windows\)](#)

## **ControlCenter4 (Windows)**

- [Change the Operation Mode in ControlCenter4 \(Windows\)](#)
- [Scan Using ControlCenter4 Home Mode \(Windows\)](#)
- [Scan Using ControlCenter4 Advanced Mode \(Windows\)](#)
- [Set Up the Brother Machine Using ControlCenter4 \(Windows\)](#)
- [Create a Custom Tab Using ControlCenter4 Advanced Mode \(Windows\)](#)
- [Set Up the Brother Machine from Your Computer \(Windows\)](#)
- [Set Up Your Machine's Address Book Using ControlCenter4 \(Windows\)](#)

## Change the Operation Mode in ControlCenter4 (Windows)

ControlCenter4 has two operation modes: **Home Mode** and **Advanced Mode**. You can change modes at any time.

### Home Mode

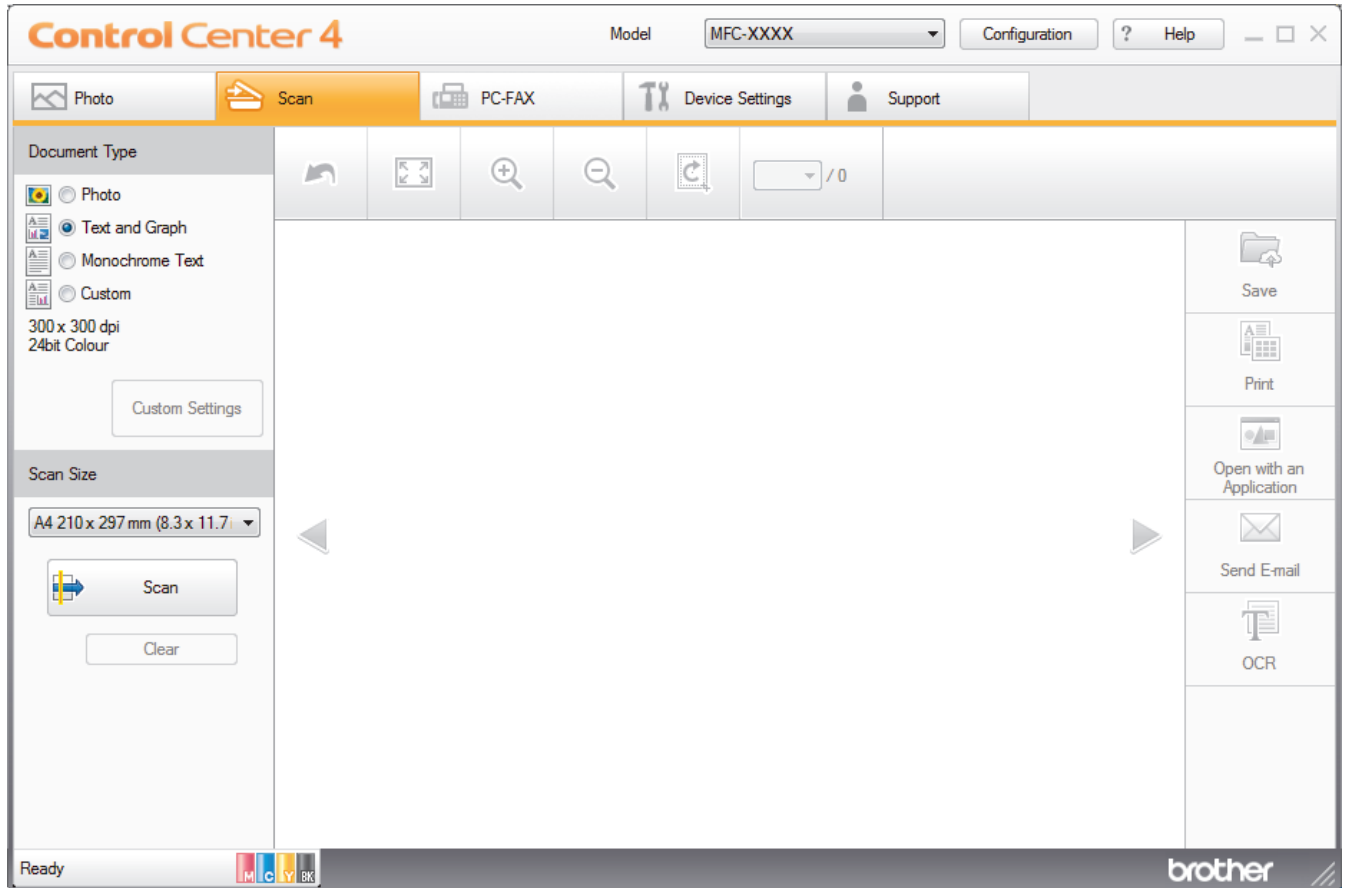

### Advanced Mode



- **Home Mode**  
ControlCenter4 Home Mode lets you access your machine's main features easily.
- **Advanced Mode**



ControlCenter4 Advanced Mode gives you more control over the details of your machine's features and allows you to customise one-button scan actions.

To change operation mode:

1. Click the  (**ControlCenter4**) icon in the task tray, and then select **Open**.
2. Click the **Configuration** button, and then select **Mode Select**.
3. The mode selection dialog box appears. Select either the **Home Mode** or **Advanced Mode** option.

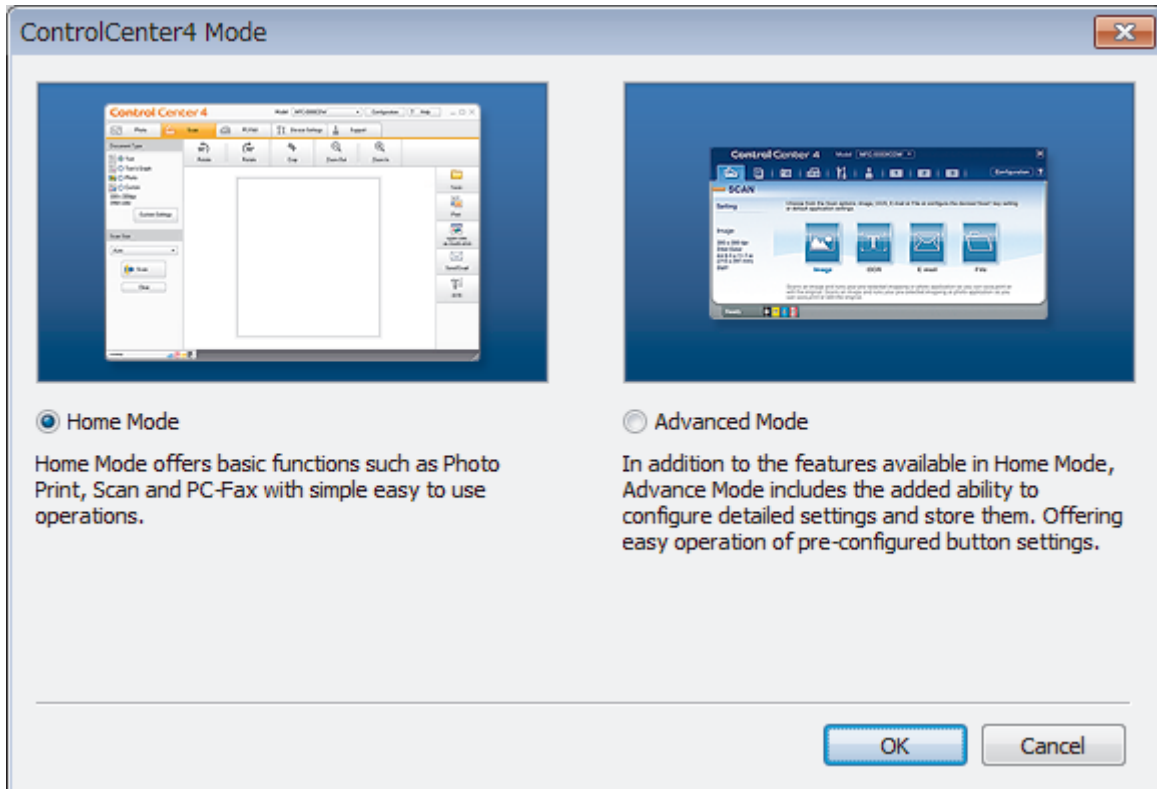

4. Click **OK**.

## Related Information

- [ControlCenter4 \(Windows\)](#)

### Related Topics:

- [Scan Using ControlCenter4 Home Mode \(Windows\)](#)
- [Scan Using ControlCenter4 Advanced Mode \(Windows\)](#)

## Scan Using ControlCenter4 Home Mode (Windows)

Use ControlCenter4 Home Mode to access your machine's main features.

- [Scan Using ControlCenter4 Home Mode \(Windows\)](#)
- [Save Scanned Data to a Folder as a PDF File Using ControlCenter4 Home Mode \(Windows\)](#)
- [Scan Settings for ControlCenter4 Home Mode \(Windows\)](#)
- [Change the Operation Mode in ControlCenter4 \(Windows\)](#)

## Scan Using ControlCenter4 Advanced Mode (Windows)

ControlCenter4 Advanced Mode gives you more control over the details of your machine's features and allows you to customise one-button scan actions.

- [Scan Photos and Graphics Using ControlCenter4 Advanced Mode \(Windows\)](#)
- [Save Scanned Data to a Folder as a PDF File Using ControlCenter4 Advanced Mode \(Windows\)](#)
- [Scan Both Sides of an ID Card Using ControlCenter4 Advanced Mode \(Windows\)](#)
- [Scan to Email Attachment Using ControlCenter4 Advanced Mode \(Windows\)](#)
- [Scan to an Editable Text File \(OCR\) Using ControlCenter4 Advanced Mode \(Windows\)](#)
- [Scan to an Office File Using ControlCenter4 Advanced Mode \(Windows\)](#)
- [Scan Settings for ControlCenter4 Advanced Mode \(Windows\)](#)
- [Change the Operation Mode in ControlCenter4 \(Windows\)](#)

## Set Up the Brother Machine Using ControlCenter4 (Windows)

Related Models: MFC-J1300DW



If Secure Function Lock is set to On, you cannot use Remote Setup.

1. Click the  (ControlCenter4) icon in the task tray, and then click **Open**.
2. Click the **Device Settings** tab.
3. Click the **Remote Setup** button.
4. Configure the settings as needed.

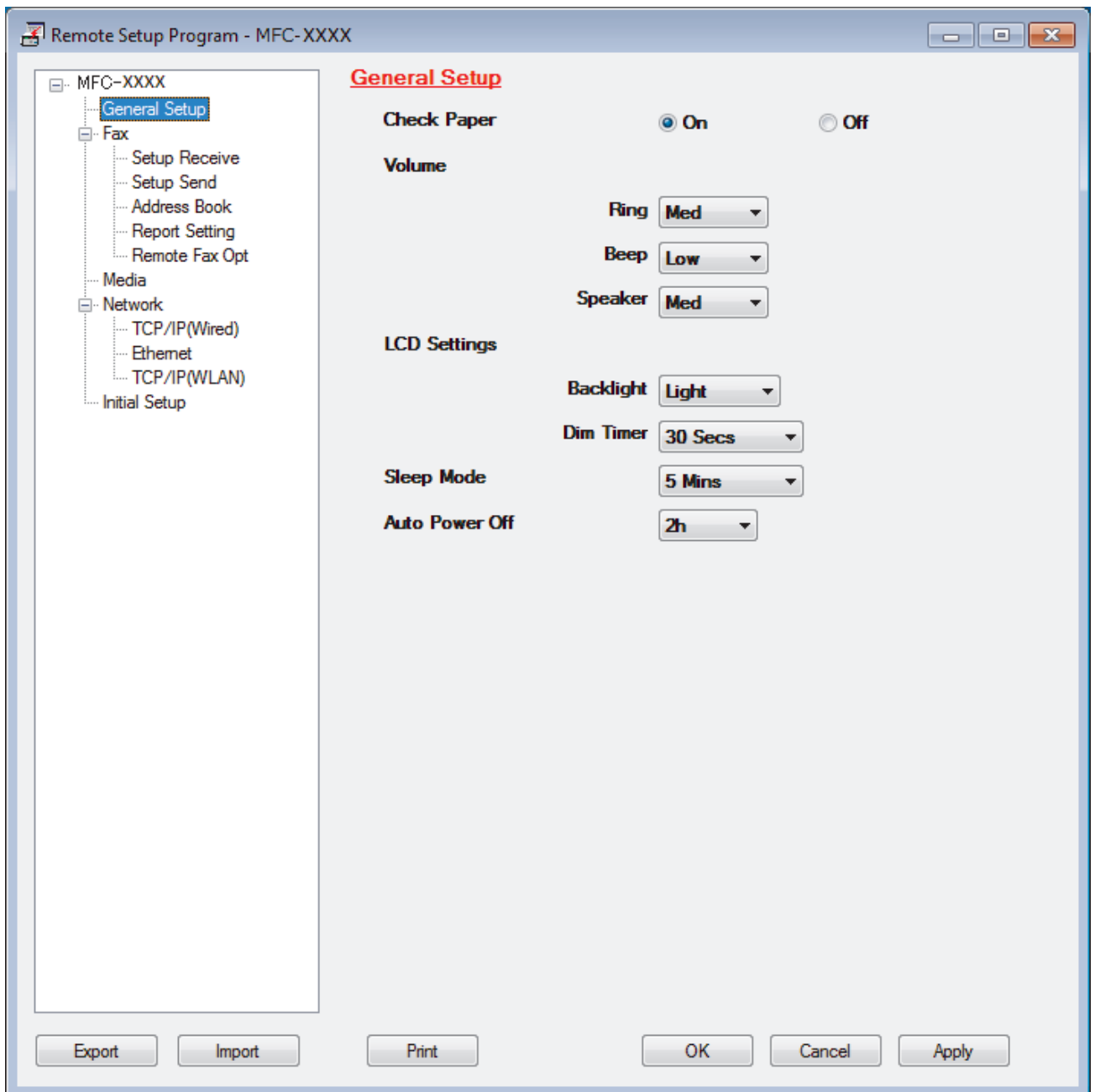

### Export

Click to save the current configuration settings to a file.



---

Click **Export** to save your address book or all settings for your machine.

---

### **Import**

Click to import a file and read its settings.

### **Print**

Click to print the selected items on the machine. You cannot print the data until it is uploaded to the machine. Click **Apply** to upload the new data to the machine, and then click **Print**.

### **OK**

Click to start uploading data to the machine, and then exit the Remote Setup Program. If an error message appears, confirm that your data is correct, and then click **OK**.

### **Cancel**

Click to exit the Remote Setup Program without uploading data to the machine.

### **Apply**

Click to upload data to the machine without exiting the Remote Setup Program.

5. Click **OK**.
- If your computer is protected by a firewall and is unable to use Remote Setup, you may need to configure the firewall settings to allow communication through port numbers 137 and 161.
  - If you are using Windows Firewall and you installed the Brother software and drivers from the Brother installation disc, the necessary firewall settings have already been set.



## **Related Information**

- [ControlCenter4 \(Windows\)](#)
  - [Remote Setup \(Windows\)](#)
-

## Create a Custom Tab Using ControlCenter4 Advanced Mode (Windows)

You can create up to three customised tabs, each including up to five customised buttons, with your preferred settings.

Select **Advanced Mode** as the mode setting for ControlCenter4.

1. Click the  (**ControlCenter4**) icon in the task tray, and then click **Open**.
2. Click the **Configuration** button, and then select **Create custom tab**.  
A custom tab is created.
3. To change the name of a custom tab, right-click the custom tab, and then select **Rename custom tab**.
4. Click the **Configuration** button, select **Create custom button**, and then select the button you want to create.  
The settings dialog box appears.
5. Type the button name, and then change the settings, if needed. Click **OK**.  
The setting options vary depending on the button you select.

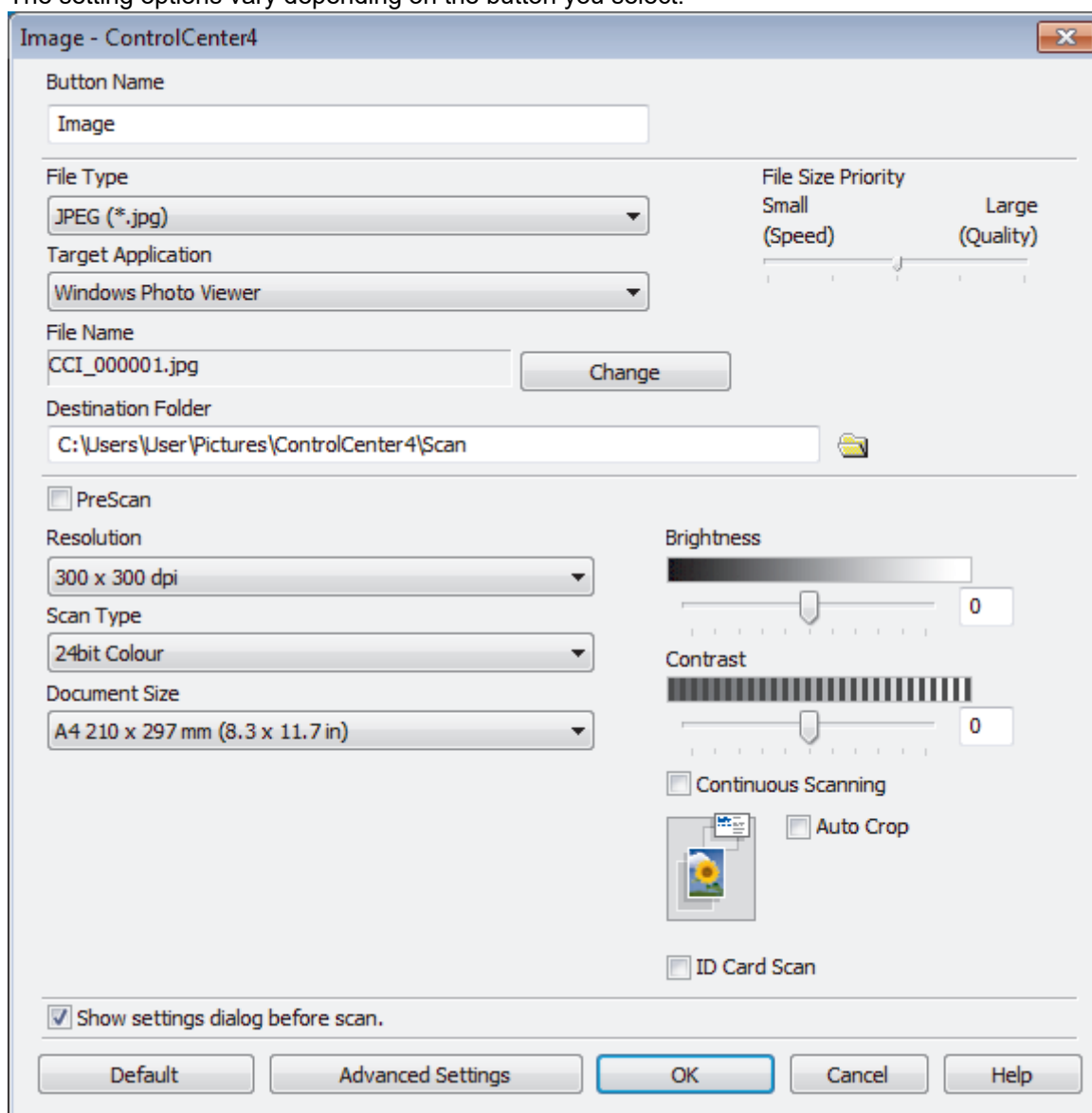

You can change or remove the created tab, button, or settings. Click the **Configuration** button, and then follow the menu.



## Related Information

- [ControlCenter4 \(Windows\)](#)

## Brother iPrint&Scan for Windows and Mac

- [Brother iPrint&Scan Overview](#)
- [Scan Using Brother iPrint&Scan \(Mac\)](#)



## Brother iPrint&Scan Overview

Use Brother iPrint&Scan for Windows and Mac to print and scan from your computer.

The following screen shows an example of Brother iPrint&Scan for Windows. The actual screen may differ depending on the version of the application.

- For Windows  
Go to your model's **Downloads** page on the Brother Solutions Center at [support.brother.com](http://support.brother.com) to download the latest application.
- For Mac  
Download and install Brother iPrint&Scan from the App Store.

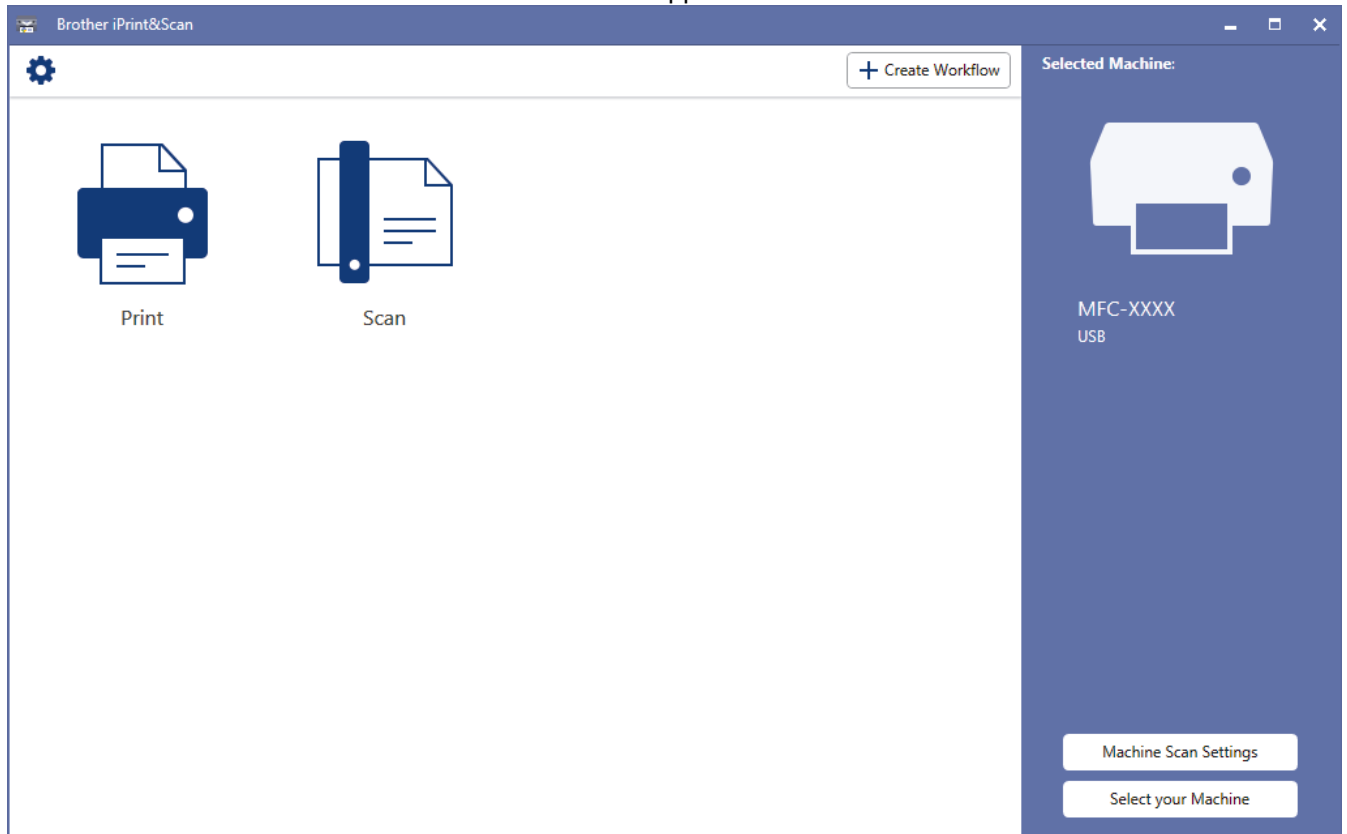

### ✓ Related Information

- [Brother iPrint&Scan for Windows and Mac](#)

#### Related Topics:

- [Brother iPrint&Scan for Mobile Devices](#)

## Troubleshooting

If you think there is a problem with your machine, first check each of the items below, then try to identify the problem, and follow our troubleshooting tips.

You can correct most problems yourself. If you need additional help, the Brother Solutions Center offers the latest **FAQs & Troubleshooting** tips.

Visit us at [support.brother.com](http://support.brother.com).

Click **FAQs & Troubleshooting** and search for your model name.

First, check the following:

- The machine's power cord is connected correctly and the machine's power is on.
- All of the machine's protective parts have been removed.
- The ink cartridges are installed correctly.
- The Scanner Cover and the Jam Clear Cover are fully closed.
- Paper is inserted correctly in the paper tray.
- The interface cables are securely connected to the machine and the computer, or the wireless connection is set up on both the machine and your computer.
- (For network models) The access point (for wireless), router, or hub is turned on and its link button is blinking.
- The machine's LCD is displaying messages.

If you did not solve the problem with the checks, identify the problem and then see *Related Information*.



### Related Information

- [Error and Maintenance Messages](#)
- [Document Jams](#)
- [Printer Jam or Paper Jam](#)
- [If You Are Having Difficulty with Your Machine](#)
- [Check the Machine Information](#)
- [Reset Your Brother Machine](#)

#### Related Topics:

- [Paper Handling and Printing Problems](#)
- [Telephone and Fax Problems](#)
- [Other Problems](#)
- [Network Problems](#)
- [Google Cloud Print Problems](#)
- [AirPrint Problems](#)

## Error and Maintenance Messages

As with any sophisticated office product, errors may occur and supply items may have to be replaced. If this happens, your machine identifies the error or required routine maintenance and shows the appropriate message. The most common error and maintenance messages are shown in the table.

You can correct most errors and perform routine maintenance yourself. If you need more tips, go to your model's **FAQs & Troubleshooting** page on the Brother Solutions Center at [support.brother.com](http://support.brother.com).



- (MFC-J1300DW)

If the touchscreen displays errors and your Android™ device supports the NFC feature, touch your device to the NFC symbol on the control panel to access the Brother Solutions Center and browse the latest FAQs from your device. (Your mobile telephone provider's message and data rates may apply.)

Make sure the NFC settings of both your Brother machine and your Android™ device are set to On.

- *Related Information* references are at the bottom of this page.

Error Message	Cause	Action
B&W Print Only Replace ink.	<p>One or more of the colour ink cartridges have reached the end of their lives.</p> <p>You can use the machine in monochrome mode for approximately four weeks depending on the number of pages you print.</p> <p>While this message appears on the touchscreen, each operation works in the following way:</p> <ul style="list-style-type: none"> <li>• <b>Printing</b> If the media type is set to <b>Plain Paper</b> in the <b>Basic</b> tab, and <b>Greyscale</b> is selected in the <b>Advanced</b> tab of the printer driver, you can use the machine as a monochrome printer.</li> <li>• <b>Copying</b> If the paper type is set to <b>Plain Paper</b>, you can make copies in monochrome.</li> <li>• <b>Faxing</b> If the paper type is set to <b>Plain Paper</b>, the machine will receive and print the faxes in monochrome.</li> </ul>	<p>Replace the ink cartridges.</p> <p>See <i>Related Information: Replace the Ink Cartridges</i>.</p> <p>Although the Cause column lists options for using the machine after this error appears, you may not be able to use the machine until you replace the ink cartridge(s) under the following conditions:</p> <ul style="list-style-type: none"> <li>• If you unplug the machine or remove the ink cartridge.</li> <li>• If you select the <b>Slow Drying Paper</b> option on the machine or in the printer driver.</li> </ul>
BT Call Sign On	BT Call Sign is set to On. You cannot change the Receive Mode from Manual to another mode.	<p>Set BT Call Sign to Off.</p> <p>See <i>Related Information: Enable the Machine to Work with BT Call Sign (with Your External Telephone only)</i>.</p>
Cannot Detect	An ink cartridge is not installed correctly.	<p>Take out the new ink cartridge and reinstall it slowly and firmly until it locks into place.</p> <p>See <i>Related Information: Replace the Ink Cartridges</i>.</p>
	If you are using non Brother Original ink, the machine may not detect the ink cartridge.	Replace the cartridge with a Brother Original ink cartridge. If the error message remains, contact Brother customer service or your local Brother dealer.

Error Message	Cause	Action
	The wrong Brother model ink cartridge was installed.	Check the model numbers of the ink cartridges and install the correct ink cartridges.
Cannot Detect Ink Volume	If you are using non Brother Original ink, the machine may not detect the ink volume.	Replace the cartridge with a Brother Original ink cartridge. If the error message remains, contact Brother customer service or your local Brother dealer.
Comm.Error	Poor telephone line quality caused a communication error.	Send the fax again or connect the machine to another telephone line. If the problem continues, contact the telephone company and ask them to check your telephone line.
Connection Error	Other devices are trying to connect to the Wi-Fi Direct network at the same time.	Make sure there are no other devices trying to connect to the Wi-Fi Direct network, and then try to configure the Wi-Fi Direct settings again.
Connection Failed	The Brother machine and your mobile device cannot communicate during the Wi-Fi Direct network configuration.	<ul style="list-style-type: none"> <li>• Move the mobile device closer to your Brother machine.</li> <li>• Move your Brother machine and the mobile device to an obstruction-free area.</li> <li>• If you are using the PIN Method of WPS, make sure you have entered the correct PIN.</li> </ul>
Cover is Open.	The scanner cover is not locked in the closed position.	Lift the scanner cover and then close it again.
	The ink cartridge cover is not locked in the closed position.	Firmly close the ink cartridge cover until it locks into place.
Data Remaining in Memory	Print data is left in the machine's memory.	Press  . The machine will cancel the job and clear it from the memory. Try to print again.
Disconnected	The other person or other person's fax machine stopped the call.	Try to send or receive again. If calls are stopped repeatedly and you are using a VoIP (Voice over IP) system, try changing the Compatibility to Basic (for VoIP). <i>See Related Information: Telephone Line Interference/VoIP.</i>
Document Jam/too Long	The document was not inserted or fed correctly, or the document scanned from the ADF was too long.	Remove the jammed document, and then press  . Set the document in the ADF correctly. <i>See Related Information: Load Documents in the Automatic Document Feeder (ADF).</i> <i>See Related Information: Document Jams.</i>
High Temperature	The room temperature is too high.	After cooling the room, allow the machine to cool down to room temperature. Try again when the machine has cooled down.

Error Message	Cause	Action
Hub is Unusable.	A hub or USB flash drive with hub has been connected to the USB direct interface.	Hubs, including a USB flash drive with a built-in hub, are not supported. Unplug the device from the USB direct interface.
Ink Absorber NearFull	The ink absorber box is nearly full.	The ink absorber box must be replaced soon. Contact Brother customer service or your local Brother dealer. <ul style="list-style-type: none"> <li>The ink absorber box absorbs the small amount of ink emitted during print head cleaning.</li> </ul>
Ink Absorber Pad Full	The ink absorber box is full. These components are periodic maintenance items that may require replacement after a period of time to ensure optimum performance from your Brother machine. Because these components are periodic maintenance items, the replacement is not covered under the warranty. The need to replace these items and the time period before replacement is dependent on the number of purges and flushes required to clean the ink system. These boxes acquire amounts of ink during the different purging and flushing operations. The number of times a machine purges and flushes for cleaning varies depending on different situations. For example, frequently powering the machine on and off will cause numerous cleaning cycles since the machine automatically cleans upon power up. The use of non-Brother ink may cause frequent cleanings because non-Brother ink could cause poor print quality which is resolved by cleaning. The more cleaning the machine requires, the faster these boxes will fill up.  <b>Repairs resulting from the use of non-Brother supplies may not be covered under the stated product warranty.</b>	The ink absorber box must be replaced. Contact Brother customer service or your local Brother Authorised Service Centre to have your machine serviced.
Ink Low	One or more of the ink cartridges are near the end of their lives. If the sending machine has the ability to convert it, the colour fax will be printed at your machine as a monochrome fax.	Order a new ink cartridge. You can continue printing until the touchscreen displays <i>Replace Ink</i> . <i>See Related Information: Replace the Ink Cartridges.</i> <ul style="list-style-type: none"> <li><b>You can still scan even if the ink is low or needs to be replaced.</b></li> </ul>
Jam A Inside/Front Repeat Jam A Inside/Front	The paper is jammed in the machine.	Remove the jammed paper. <i>See Related Information: Paper is Jammed Inside and in the Front of the Machine (Jam A Inside/Front).</i> Make sure the paper guides are set to the correct paper size.
	More than one sheet of paper was placed in the manual feed slot. <b>-OR-</b> Another sheet of paper was placed in the manual feed slot before the touchscreen displayed <i>Where to Place the Paper</i> .	Do not put more than one sheet of paper in the manual feed slot at any one time. Wait until the touchscreen displays <i>Where to Place the Paper</i> before you feed the next sheet of paper in the manual feed slot. Remove the jammed paper.

Error Message	Cause	Action
		See <i>Related Information: Paper is Jammed Inside and in the Front of the Machine (Jam A Inside/Front)</i> .
Jam B Front Repeat Jam B Front	The paper is jammed in the machine.	Remove the jammed paper. See <i>Related Information: Paper is Jammed in the Front of the Machine (Jam B Front)</i> . Make sure the paper guides are set to the correct paper size.
Jam C Rear	The paper is jammed in the machine.	Remove the jammed paper. See <i>Related Information: Paper is Jammed in the Back of the Machine (Jam C Rear)</i> . Make sure the paper guides are set to the correct paper size.
	Paper dust has accumulated on the surface of the paper pick-up rollers.	Clean the paper pick-up rollers. See <i>Related Information: Clean the Paper Pick-up Rollers</i> .
Low Temperature	The room temperature is too low.	After warming the room, allow the machine to warm up to room temperature. Try again when the machine has warmed up.
Media card error	Multiple data storage devices were in the machine when it was turned on. The machine can read only one memory card or USB flash drive at a time.	Remove the memory card(s) or USB flash drive that you are not using.
Media Error	The memory card is either corrupted, incorrectly formatted, or there is a problem with the memory card.	Remove the memory card from the media drive (slot) of the machine and format it correctly.
		Put the card firmly into the slot again to make sure it is in the correct position. If the error remains, check the media drive (slot) of the machine by putting in another memory card that you know is working.
Media is Full.	The memory card or USB flash drive you are using already contains 999 files.	Your machine can only save to your memory card or USB flash drive if it contains fewer than 999 files. Delete unused files and try again.
	The memory card or USB flash drive you are using does not have enough free space to scan the document.	Delete unused files from your memory card or USB flash drive to make some free space, and then try again.
No Caller ID	There is no incoming call history. You did not receive calls or you have not subscribed to the Caller ID service from your telephone company.	To use the Caller ID feature, contact your telephone company. See <i>Related Information: Caller ID</i> .
No Device	When configuring the Wi-Fi Direct network, the Brother machine cannot find your mobile device.	<ul style="list-style-type: none"> <li>• Make sure your machine and mobile device are in the Wi-Fi Direct mode.</li> <li>• Move the mobile device closer to your Brother machine.</li> <li>• Move your Brother machine and the mobile device to an obstruction-free area.</li> <li>• If you are manually configuring the Wi-Fi Direct network, make sure you have entered the correct password.</li> </ul>

Error Message	Cause	Action
		<ul style="list-style-type: none"> <li>If your mobile device has a configuration page for how to obtain an IP address, make sure the IP address of your mobile device has been configured via DHCP.</li> </ul>
No File	The memory card or USB flash drive in the media drive does not contain a .JPG file.	Put the correct memory card or USB flash drive into the slot again.
No Ink Cartridge	An ink cartridge is not installed correctly.	Remove the ink cartridge and re-install it slowly and firmly until it locks into place. <i>See Related Information: Replace the Ink Cartridges.</i>
No Paper Fed	The machine is out of paper or paper is not correctly loaded in the paper tray.	Do one of the following: <ul style="list-style-type: none"> <li>Refill the paper tray, and then follow the LCD instructions.</li> <li>Remove and reload the paper, and then follow the LCD instructions.</li> </ul> <i>See Related Information: Load Paper.</i>
	The paper was not inserted in the centre position of the manual feed slot.	Remove the paper and reinsert it in the centre of the manual feed slot, and then follow the LCD instructions. <i>See Related Information: Load Paper in the Manual Feed Slot.</i>
	The Jam Clear Cover is not closed correctly.	Make sure the Jam Clear Cover is closed evenly at both ends. <i>See Related Information: Printer Jam or Paper Jam.</i>
	Paper dust has accumulated on the surface of the paper pick-up rollers.	Clean the paper pick-up rollers. <i>See Related Information: Clean the Paper Pick-up Rollers.</i>
No Response/Busy	The number you dialled does not answer or is busy.	Verify the number and try again.
Out of Fax Memory	The fax memory is full.	Do one of the following: <ul style="list-style-type: none"> <li>Clear the data from the memory. To gain extra memory, you can turn off Memory Receive. <i>See Related Information: Turn Off Memory Receive.</i></li> <li>Print the faxes that are in the memory. <i>See Related Information: Print a Fax Stored in the Machine's Memory.</i></li> </ul>
Out of Memory	The machine's memory is full.	If a fax-sending or copy operation is in progress: <ul style="list-style-type: none"> <li>Press  or Quit and wait until the other operations that are in progress finish, and then try again.</li> <li>Press Partial Print to copy the pages scanned so far.</li> <li>Clear the data in the memory. To gain extra memory, you can turn Memory Receive off. <i>See Related Information: Turn Off Memory Receive.</i></li> <li>Print the faxes stored in the memory.</li> </ul>

Error Message	Cause	Action
		See <i>Related Information: Print a Fax Stored in the Machine's Memory.</i>
Paper Size Mismatch	<p>The paper size setting does not match the size of paper in the tray.</p> <p><b>-OR-</b></p> <p>You did not set the paper guides in the tray to the indicators for the paper size you are using.</p>	<ol style="list-style-type: none"> <li>1. Check that the paper size you selected on the machine's display matches the size of the paper in the tray. See <i>Related Information: Change the Paper Size and Paper Type.</i></li> <li>2. Make sure you loaded the paper in the correct orientation and set the paper guides at the indicators for your paper size. See <i>Related Information: Load Paper.</i></li> <li>3. After you have checked the paper size and the paper orientation, follow the LCD instructions.</li> </ol> <p>If printing from your computer, make sure the paper size you selected in the printer driver matches the size of paper in the tray. See <i>Related Information: Print Settings (Windows) or Print Options (Mac).</i></p>
Paper Tray not detected	<p>The paper tray is not completely inserted.</p> <p>Paper or a foreign object has prevented the paper tray from being inserted correctly.</p>	<p>Slowly push the paper tray completely into the machine.</p> <p>Pull the paper tray out of the machine, and remove the jammed paper or foreign object. If you cannot find or remove the jammed paper, see <i>Related Information: Printer Jam or Paper Jam.</i></p>
Repetitive No Paper Fed	Paper dust has accumulated on the surface of the paper pick-up rollers.	<p>Clean the paper pick-up rollers. See <i>Related Information: Clean the Paper Pick-up Rollers.</i></p>
Replace Ink	<p>One or more of the ink cartridges have reached the end of their lives. The machine will stop all print operations. While memory is available, monochrome faxes will be stored in the memory. If the sending machine has the ability to convert it, the colour fax will be stored in the memory as a monochrome fax.</p>	<p>Replace the ink cartridges. See <i>Related Information: Replace the Ink Cartridges.</i></p> <ul style="list-style-type: none"> <li>• You can still scan even if the ink is low or needs to be replaced.</li> </ul>
The maximum number of devices are already connected using Wi-Fi Direct.	The maximum number of mobile devices are already connected to the Wi-Fi Direct network when the Brother machine is the Group Owner (G/O).	<p>After the current connection between your Brother machine and another mobile device has shut down, try to configure the Wi-Fi Direct settings again. You can confirm the connection status by printing the Network Configuration Report. See <i>Related Information: Print the Network Configuration Report.</i></p>
Touchscreen Init. Failed	<p>The touchscreen was pressed before the power on initialisation was completed.</p> <p>Debris may be stuck between the lower part of the touchscreen and its frame.</p>	<p>Make sure nothing is touching or resting on the touchscreen, especially when plugging the machine in.</p> <p>Insert a piece of stiff paper between the lower part of the touchscreen and its frame and slide it back and forth to push out the debris.</p>



Error Message	Cause	Action
Tray Settings	This message is displayed when the setting to confirm the paper type and size is enabled.	To not display this confirmation message, change the setting to Off. <i>See Related Information: Change the Check Paper Size Setting.</i>
Unable to Clean XX Unable to Initialize XX Unable to Print XX	The machine has a mechanical problem. <b>-OR-</b> A foreign object, such as a paper clip or a piece of ripped paper, is in the machine.	Open the scanner cover and remove any foreign objects and paper scraps from inside the machine. If the error message continues, disconnect the machine from the power for several minutes, and then reconnect it. <i>See Related Information: Paper is Jammed Inside and in the Front of the Machine (Jam A Inside/Front).</i> (MFC-J1300DW) If you cannot print received faxes, transfer them to another fax machine or to your computer. <i>See Related Information: Transfer Your Faxes or Fax Journal Report.</i>
Unable to Scan XX	The machine has a mechanical problem.	Disconnect the machine from the power for several minutes, and then reconnect it. (MFC-J1300DW) If you cannot print received faxes, transfer them to another fax machine or to your computer. <i>See Related Information: Transfer Your Faxes or Fax Journal Report.</i>
Unusable Device Disconnect device from front connector & turn machine off & then on	A broken device is connected to the USB direct interface.	Unplug the device from the USB direct interface, then press  to turn the machine off and then on again.
Unusable Device Please disconnect USB device.	A USB device or USB flash drive that is not supported has been connected to the USB direct interface.	Unplug the device from the USB direct interface. Turn the machine off and then on again.
Wrong Ink Cartridge	The ink cartridge model number is not compatible with your machine.	Verify whether the cartridge model number will work with your machine.
Wrong Ink Colour	An ink cartridge has been installed in the wrong position.	Check which ink cartridges are not matched by colour to their ink cartridge positions and move them to their correct positions.



## Related Information

- [Troubleshooting](#)
  - [Transfer Your Faxes or Fax Journal Report](#)
  - [Error Messages When Using the Brother Web Connect Feature](#)

### Related Topics:

- [Touchscreen LCD Overview](#)
- [Print the Network Configuration Report](#)
- [Replace the Ink Cartridges](#)
- [Change the Check Paper Size Setting](#)
- [Telephone Line Interference/VoIP](#)
- [Load Documents in the Automatic Document Feeder \(ADF\)](#)
- [Document Jams](#)

- 
- Enable the Machine to Work with BT Call Sign (with Your External Telephone only)
  - Caller ID
  - Load Paper
  - Load Paper in the Manual Feed Slot
  - Printer Jam or Paper Jam
  - Clean the Paper Pick-up Rollers
  - Turn Off Memory Receive
  - Print a Fax Stored in the Machine's Memory
  - Change the Paper Size and Paper Type
  - Print Settings (Windows)
  - Print Options (Mac)
  - Paper is Jammed Inside and in the Front of the Machine (Jam A Inside/Front)
  - Paper is Jammed in the Front of the Machine (Jam B Front)
  - Paper is Jammed in the Back of the Machine (Jam C Rear)
  - Paper Handling and Printing Problems
-

## Transfer Your Faxes or Fax Journal Report

**Related Models:** MFC-J1300DW

If the LCD shows:

- [Unable to Clean XX]
- [Unable to Initialize XX]
- [Unable to Print XX]
- [Unable to Scan XX]

We recommend transferring your faxes to another fax machine or to your computer.

See *Related Information: Transfer Faxes to Another Fax Machine*.

See *Related Information: Transfer Faxes to Your Computer*.

You can also transfer the Fax Journal report to see if there are any faxes you must transfer.

See *Related Information: Transfer the Fax Journal Report to Another Fax Machine*.



### Related Information

- [Error and Maintenance Messages](#)
  - [Transfer Faxes to Another Fax Machine](#)
  - [Transfer Faxes to Your Computer](#)
  - [Transfer the Fax Journal Report to Another Fax Machine](#)



#### Related Topics:

- [Use PC-Fax Receive to Transfer Received Faxes to Your Computer \(Windows only\)](#)
- [Reset the Network Settings to Factory Default](#)
- [Reset Your Brother Machine](#)
- [Reset Functions Overview](#)

## Transfer Faxes to Another Fax Machine

**Related Models:** MFC-J1300DW

If you have not set up your Station ID, you cannot enter Fax Transfer mode.

1. Press  to interrupt the error temporarily.
2. Press  [Settings] > [All Settings] > [Service] > [Data Transfer] > [Fax Transfer].
3. Do one of the following:
  - If the touchscreen displays [No Data], there are no faxes left in the machine's memory.  
Press [Close], and then press .
  - Enter the fax number where faxes will be forwarded.
4. Press [Fax Start].



### Related Information

- [Transfer Your Faxes or Fax Journal Report](#)

#### Related Topics:

- [Set Your Station ID](#)

## Transfer Faxes to Your Computer

**Related Models:** MFC-J1300DW

You can transfer the faxes from your machine's memory to your computer.

1. Press  to interrupt the error temporarily.
2. Make sure you have installed the Brother software and drivers on your computer, and then turn on **PC-FAX Receive** on the computer. Do one of the following:

- Windows 7

From the  (**Start**) menu, select **All Programs > Brother > Brother Utilities**.

Click the drop-down list and select your model name (if not already selected). Click **PC-FAX** in the left navigation bar, and then click **Receive**.

- Windows 8 and Windows 10

Click  (**Brother Utilities**), and then click the drop-down list and select your model name (if not already selected). Click **PC-FAX** in the left navigation bar, and then click **Receive**.

3. Read and confirm the instructions on your computer.

Faxes in the machine's memory will be sent to your computer automatically.



### **When faxes in the machine's memory are not sent to your computer:**

Make sure you have set [PC Fax Receive] on the machine.

If faxes are in the machine's memory when you set up PC-Fax Receive, the touchscreen will ask if you want to transfer the faxes to your computer.

If Fax Preview is set to Off, you will be asked if you want to print backup copies.

Press [Yes] to transfer all faxes in the memory to your computer.



### **Related Information**

- [Transfer Your Faxes or Fax Journal Report](#)



#### **Related Topics:**

- [Use PC-Fax Receive to Transfer Received Faxes to Your Computer \(Windows only\)](#)

## Transfer the Fax Journal Report to Another Fax Machine

**Related Models:** MFC-J1300DW

If you have not set up your Station ID, you cannot enter fax transfer mode.

1. Press  to interrupt the error temporarily.
2. Press  [Settings] > [All Settings] > [Service] > [Data Transfer] > [Report Transfer].
3. Enter the fax number where the Fax Journal report will be forwarded.
4. Press [Fax Start].

### Related Information

- [Transfer Your Faxes or Fax Journal Report](#)

#### Related Topics:

- [Set Your Station ID](#)

## Error Messages When Using the Brother Web Connect Feature

Your Brother machine displays an error message if an error occurs. The most common error messages are shown in the following chart.

You can correct most errors yourself. If you need more tips, go to your model's **FAQs & Troubleshooting** page on the Brother Solutions Center at [support.brother.com](http://support.brother.com).

### Connection Error

Error Messages	Cause	Action
Connection Error 02 Network is not connected. Check that the machine is connected to the network.	The machine is not connected to a network.	<ul style="list-style-type: none"> <li>Verify that the network connection is good.</li> <li>If the <b>Web</b> or <b>Apps</b> option was pressed soon after the machine was turned on, the network connection may not have been established yet. Wait and try again.</li> </ul>
Connection Error 03 Connection failed to server. Check network settings.	<ul style="list-style-type: none"> <li>Network or server settings are incorrect.</li> <li>There is a problem with the network or server.</li> </ul>	<ul style="list-style-type: none"> <li>Confirm that network settings are correct, or wait and try again later.</li> <li>If the <b>Web</b> or <b>Apps</b> option was pressed soon after the machine was turned on, the network connection may not have been established yet. Wait and try again.</li> </ul>
Connection Error 07 Connection failed to server. Set the correct Date&Time.	Date and time settings are incorrect.	Set the date and time correctly. Note that if the machine's power cord is disconnected, the date and time settings may have reset to factory settings.

### Authentication Error

Error Messages	Cause	Action
Authentication Error 01 Incorrect PIN code. Enter PIN correctly.	The PIN you entered to access the account is incorrect. The PIN is the four-digit number that was entered when registering the account to the machine.	Enter the correct PIN.
Authentication Error 02 Incorrect or expired ID, or this temporary ID is already used. Enter correctly or reissue temporary ID. Temporary ID is valid for 24 hours after it is issued.	The temporary ID that was entered is incorrect.	Enter the correct temporary ID.
	The temporary ID that was entered has expired. A temporary ID is valid for 24 hours.	Apply for Brother Web Connect access again and receive a new temporary ID, and then use the new ID to register the account to the machine.
Authentication Error 03 Display name has already been registered. Enter another display name.	The name you entered as the display name has already been registered to another service user.	Enter a different display name.

## Server Error

Error Messages	Cause	Action
Server Error 01 Authentication failed. Do the following: 1. Go to <a href="http://bwc.brother.com">http://bwc.brother.com</a> to get a new temporary ID. 2. Press OK and enter your new temporary ID in the next screen.	The machine's authentication information (needed to access the service) has expired or is invalid.	Apply for Brother Web Connect access again to receive a new temporary ID, and then use the new ID to register the account to the machine.
Server Error 03 Failed to upload. Unsupported file or corrupt data. Confirm data of file.	The file you are trying to upload may have one of the following problems: <ul style="list-style-type: none"><li>• The file exceeds the service's limit on number of pixels, file size, etc.</li><li>• The file type is not supported.</li><li>• The file is corrupted.</li></ul>	The file cannot be used: <ul style="list-style-type: none"><li>• Check the service's size or format restrictions.</li><li>• Save the file as a different type.</li><li>• If possible, get a new, uncorrupted version of the file.</li></ul>
Server Error 13 Service temporarily unavailable. Try again later.	There is a problem with the service and it cannot be used now.	Wait and try again. If you get the message again, access the service from a computer to confirm if it is unavailable.

## Shortcut Error

Error Messages	Cause	Action
Shortcut Error 02 Account is invalid. Please register account and shortcut again after deleting this shortcut.	The shortcut cannot be used because the account was deleted after the shortcut was registered.	Delete the shortcut, and then register the account and shortcut again.



### Related Information

- [Error and Maintenance Messages](#)





## Document Jams

- [Document is Jammed in the Top of the ADF Unit](#)
- [Document is Jammed inside the ADF Unit](#)
- [Remove Paper Scraps Jammed in the ADF](#)
- [Error and Maintenance Messages](#)

## Document is Jammed in the Top of the ADF Unit

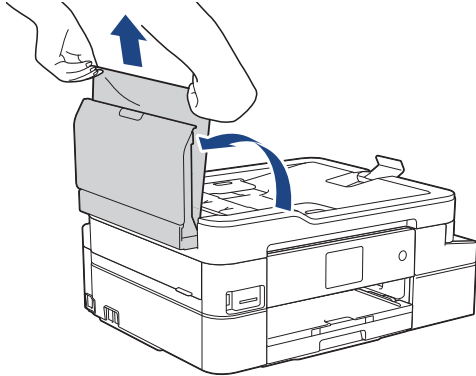
1. Remove any paper that is not jammed from the ADF.
2. Open the ADF cover.
3. Remove the jammed document by pulling it upwards.



4. Close the ADF cover.
5. Press .

### IMPORTANT

To avoid future document jams, close the ADF cover correctly by pressing it down in the centre.





### Related Information

- [Document Jams](#)

## Document is Jammed inside the ADF Unit

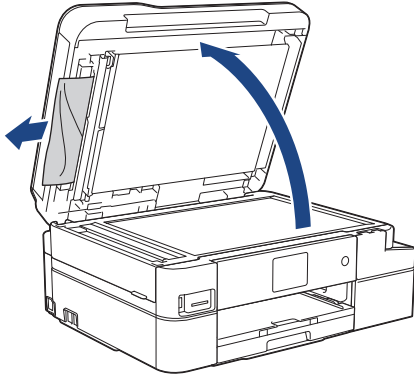
1. Remove any paper that is not jammed from the ADF.
2. Lift the document cover.
3. Pull the jammed document out to the left.



4. Close the document cover.
5. Press .





### Related Information

- [Document Jams](#)

## Remove Paper Scraps Jammed in the ADF

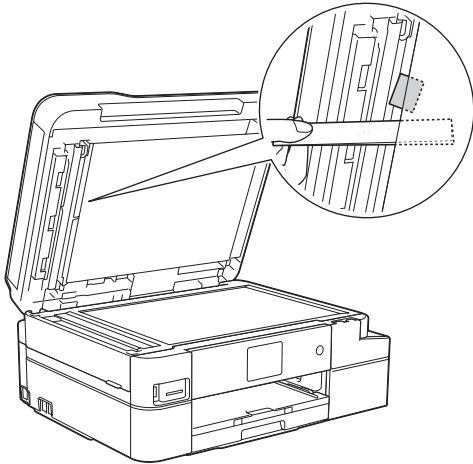
1. Lift the document cover.
2. Insert a piece of stiff paper, such as cardstock, into the ADF to push any small paper scraps through.



3. Close the document cover.
4. Press .



### Related Information

- [Document Jams](#)

## Printer Jam or Paper Jam

Locate and remove the jammed paper.

- [Paper is Jammed Inside and in the Front of the Machine \(Jam A Inside/Front\)](#)
- [Paper is Jammed in the Front of the Machine \(Jam B Front\)](#)
- [Paper is Jammed in the Back of the Machine \(Jam C Rear\)](#)
- [Error and Maintenance Messages](#)
- [Paper Handling and Printing Problems](#)

## Paper is Jammed Inside and in the Front of the Machine (Jam A Inside/Front)

If the LCD displays [Jam A Inside/Front] or [Repeat Jam A Inside/Front], follow these steps:

1. Unplug the machine from the electrical socket.
2. Pull the paper tray (1) completely out of the machine.

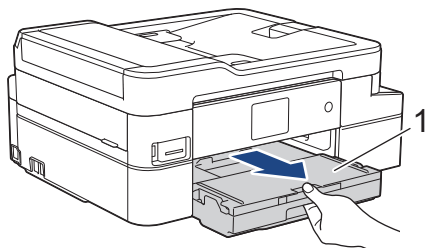

3. Pull the two green levers inside the machine to release the jammed paper.

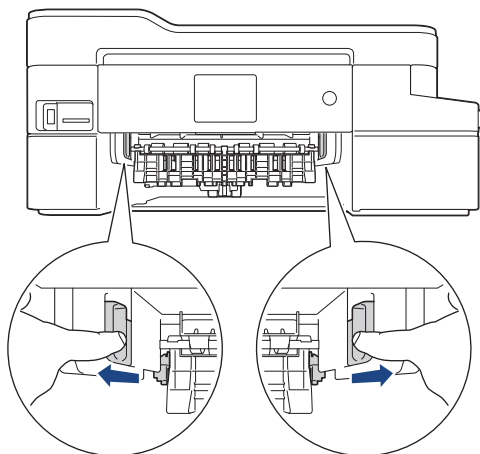

4. Place both hands under the plastic tabs on both sides of the machine to lift the scanner cover (1) into the open position.

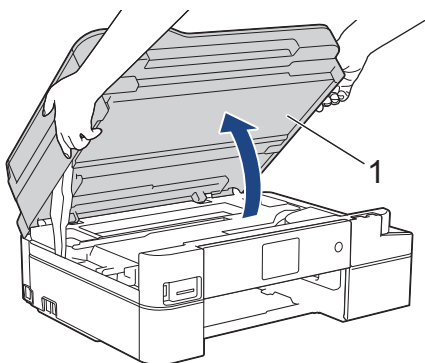

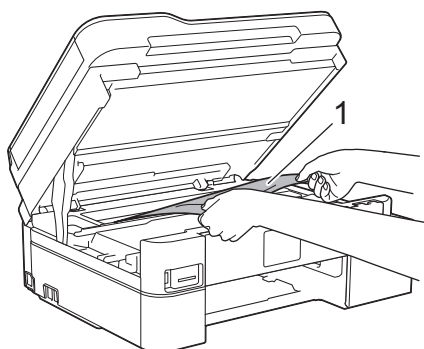

5. Slowly pull the jammed paper (1) out of the machine.

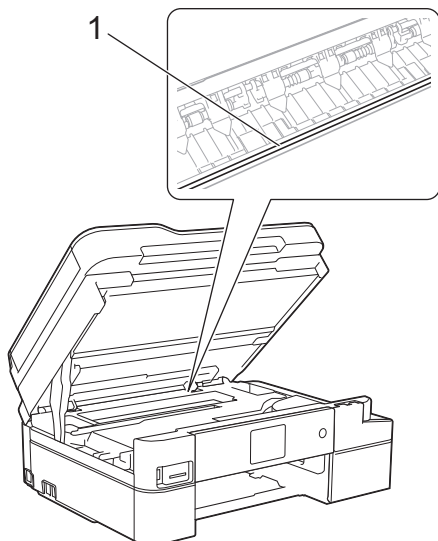

## IMPORTANT

- DO NOT touch the encoder strip, a thin strip of plastic that stretches across the width of the machine (1). Doing this may cause damage to the machine.



- If the print head is in the right corner as shown in the illustration (2), you cannot move it. Follow these steps:
  - a. Close the scanner cover, and then reconnect the power cord.
  - b. Open the scanner cover again, and then hold down  until the print head moves to the centre.
  - c. Unplug the machine from the power source and remove the jammed paper.

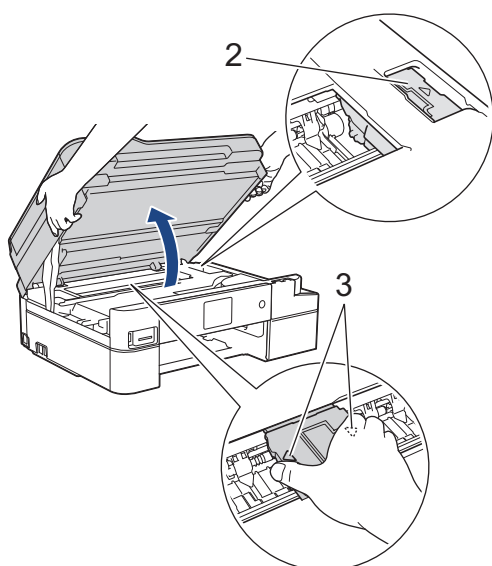

- If the paper is jammed under the print head, unplug the machine from the power source, and then move the print head to take out the paper.  
Hold the concave areas with the triangle marks as shown in the illustration (3) to move the print head.
- If ink gets on your skin or clothing, immediately wash it off with soap or detergent.



If your LCD error message was [Repeat Jam A Inside/Front], move the print head (if needed) to take out any paper remaining in this area. Make sure scraps of paper are not left in the corners of the machine (1) and (2).

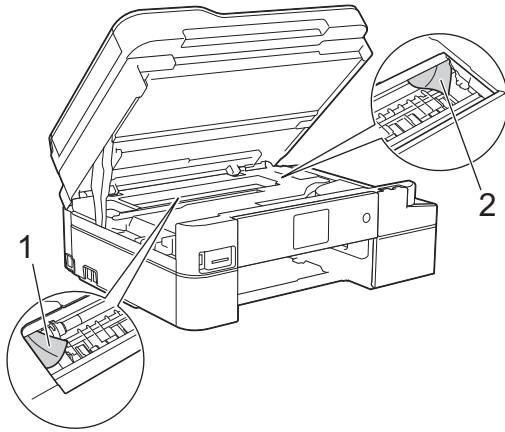

When finished, continue with the next step.

6. Gently close the scanner cover using both hands.

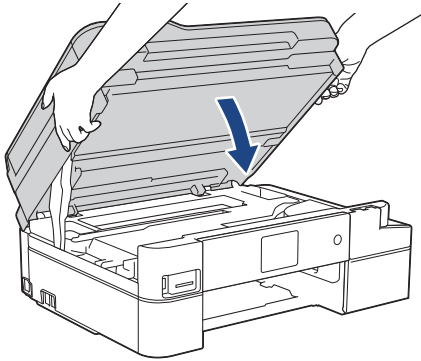

7. Slowly pull the jammed paper (1) out of the machine.

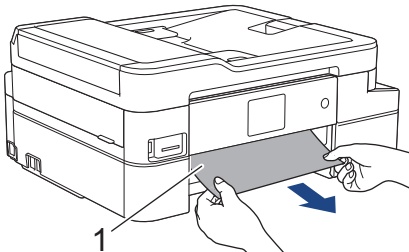





If your LCD error message was [Repeat Jam A Inside/Front], do the following:

- a. Make sure you look carefully inside (1) for any scraps of paper.

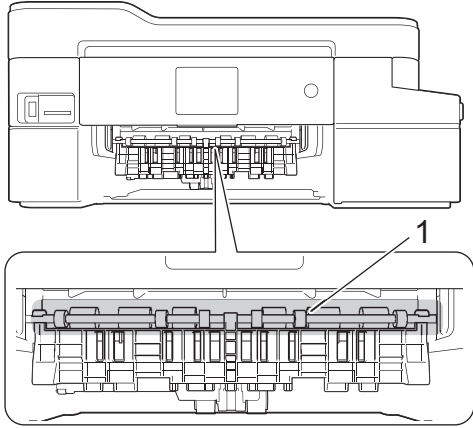

- b. Squeeze both levers (1), and then open the Jam Clear Cover at the back of the machine.

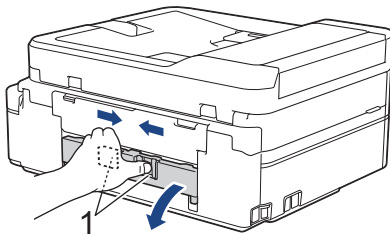

- c. Slowly pull the jammed paper out of the machine.

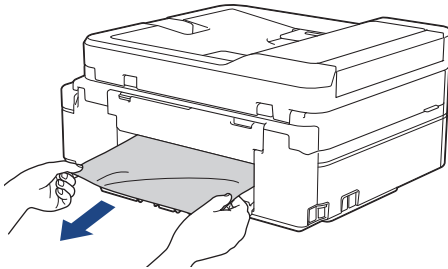

- d. Close the Jam Clear Cover. Make sure the cover is closed completely.

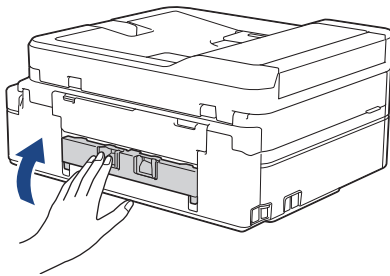

When finished, continue with the next step.

8. Put the paper tray firmly back in the machine.

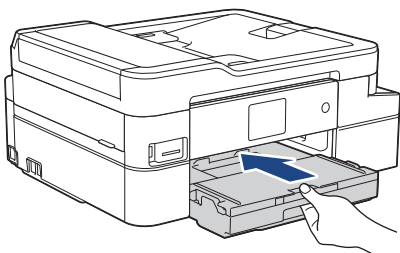

- 
9. While holding the paper tray in the machine, pull out the paper support (1) until it locks into place, and then unfold the paper support flap (2).

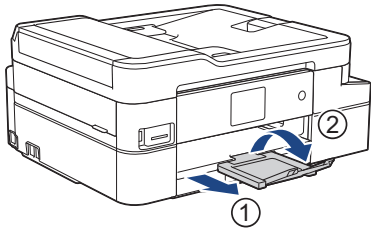

10. Reconnect the power cord.



### Related Information

- [Printer Jam or Paper Jam](#)

#### Related Topics:

- [Error and Maintenance Messages](#)
-

## Paper is Jammed in the Front of the Machine (Jam B Front)

If the LCD displays [Jam B Front] or [Repeat Jam B Front], follow these steps:

1. Unplug the machine from the electrical socket.
2. Pull the paper tray (1) completely out of the machine.

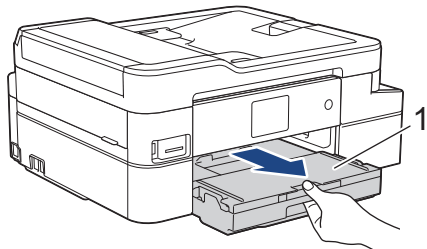

3. Pull the two green levers inside the machine to release the jammed paper.

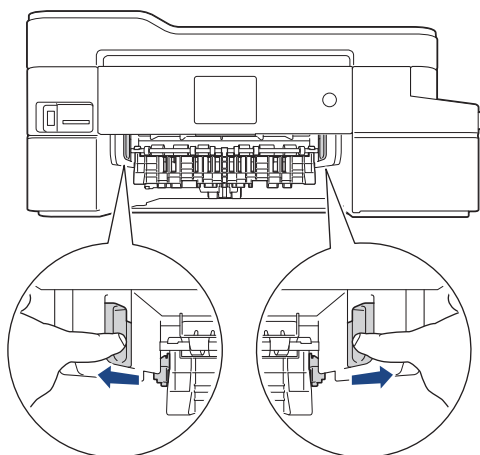

4. Slowly pull out the jammed paper (1).

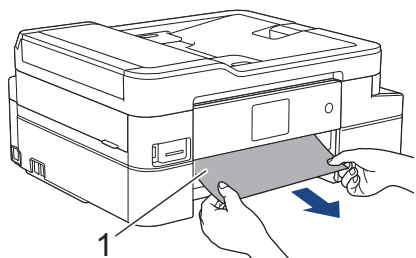



If your LCD error message was [Repeat Jam B Front], do the following:

- a. Make sure you look carefully inside (1) for any scraps of paper.

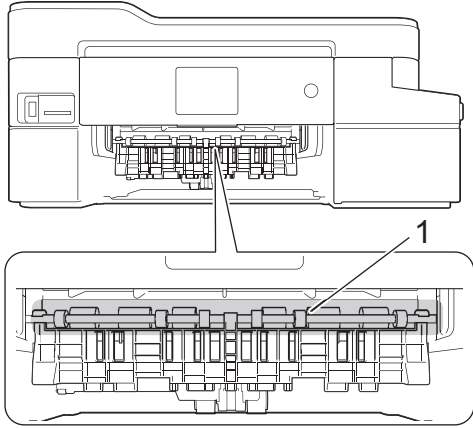

- b. Squeeze both levers (1), and then open the Jam Clear Cover at the back of the machine.

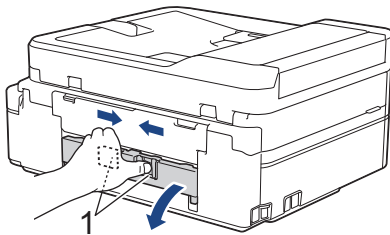

- c. Slowly pull the jammed paper out of the machine.

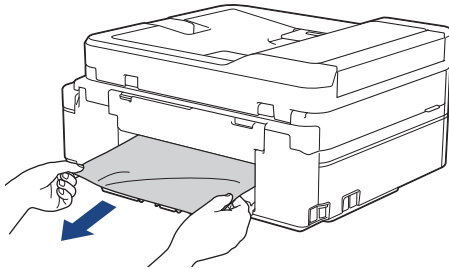

- d. Close the Jam Clear Cover. Make sure the cover is closed completely.

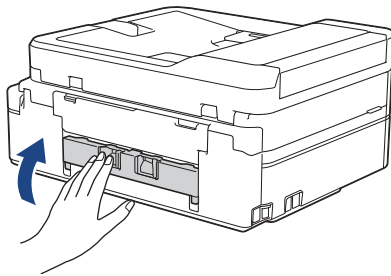

When finished, continue with the next step.

5. Put the paper tray firmly back in the machine.

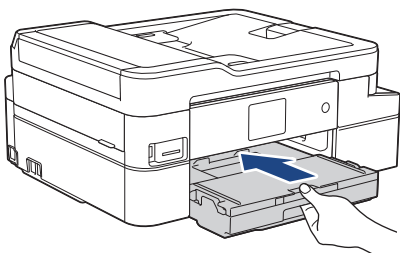

- 
6. While holding the paper tray in the machine, pull out the paper support (1) until it locks into place, and then unfold the paper support flap (2).

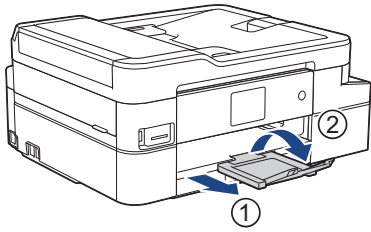

7. Reconnect the power cord.



### Related Information

- [Printer Jam or Paper Jam](#)

#### Related Topics:

- [Error and Maintenance Messages](#)
-

## Paper is Jammed in the Back of the Machine (Jam C Rear)

If the LCD displays [Jam C Rear], follow these steps:

1. Unplug the machine from the electrical socket.
2. Pull the paper tray (1) completely out of the machine.

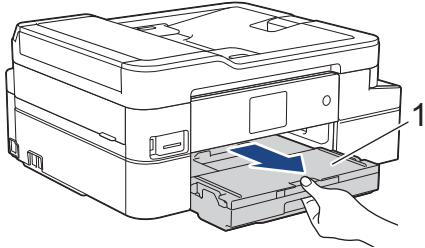

3. Pull the two green levers inside the machine to release the jammed paper.

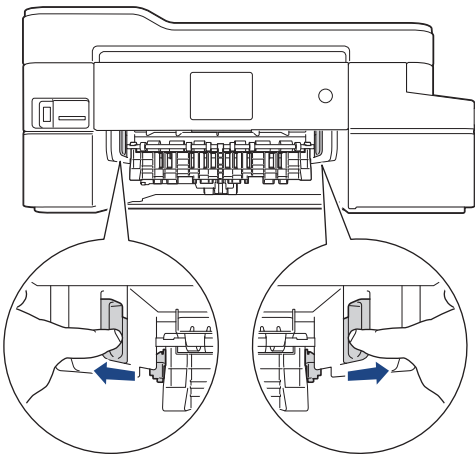

Depending on the paper size, it is easier to remove the jammed paper from the front of the machine rather than from the back of the machine.

4. Squeeze both levers (1), and then open the Jam Clear Cover at the back of the machine.

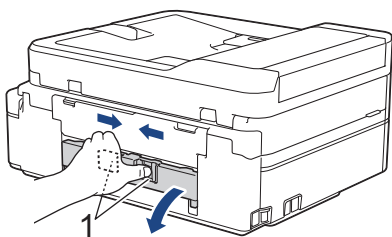

5. Slowly pull the jammed paper out of the machine.

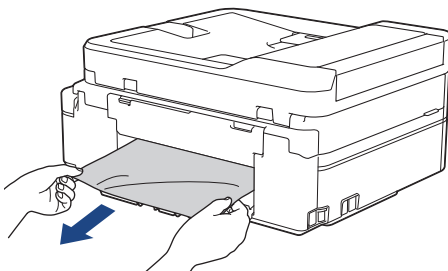

6. Close the Jam Clear Cover. Make sure the cover is closed completely.

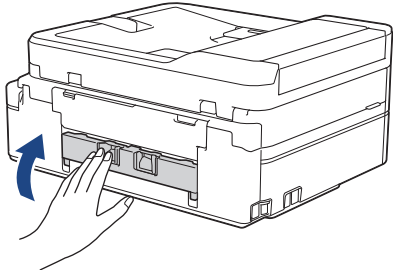

7. Put the paper tray firmly back in the machine.

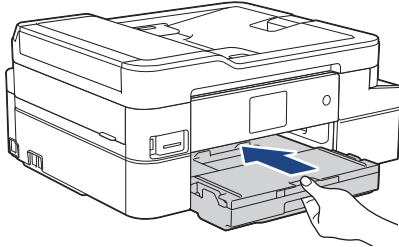

8. While holding the paper tray in the machine, pull out the paper support (1) until it locks into place, and then unfold the paper support flap (2).

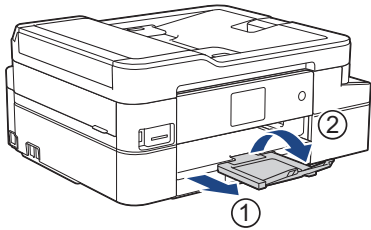

9. Reconnect the power cord.



### Additional paper jam clear operations

If the LCD error message continues to appear and you repeatedly experience paper jams, do the following:

1. Unplug the machine from the electrical socket and open the manual feed slot cover.
2. Load one sheet of thick A4 or Letter sized paper, such as glossy paper, in the manual feed slot. Insert the paper deep into the manual feed slot.

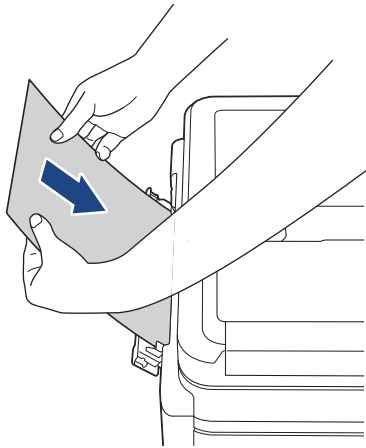

3. Re-connect the power cord.

The paper you placed in the manual feed slot will be fed through the machine and ejected. If the thick paper is pushing any jammed paper out, remove the jammed paper.

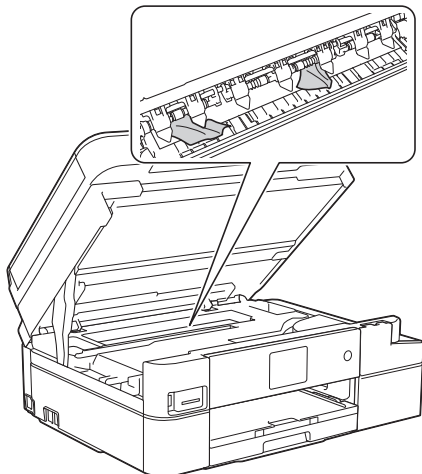

### Related Information

- [Printer Jam or Paper Jam](#)

#### Related Topics:

- [Error and Maintenance Messages](#)



## If You Are Having Difficulty with Your Machine



For technical help, you must contact Brother customer support.

If you think there is a problem with your machine, check the following topics. You can correct most problems yourself.

If you need additional help, go to your model's **FAQs & Troubleshooting** page on the Brother Solutions Center at [support.brother.com](http://support.brother.com).

Using non-Brother supplies may affect the print quality, hardware performance, and machine reliability.



- [Paper Handling and Printing Problems](#)
- [Telephone and Fax Problems](#)
- [Other Problems](#)
- [Network Problems](#)
- [Google Cloud Print Problems](#)
- [AirPrint Problems](#)



## Paper Handling and Printing Problems

If, after reading this table, you still need help, go to the Brother Solutions Center at [support.brother.com](http://support.brother.com).

- >> [Printing Difficulties](#)
- >> [Print Quality Difficulties](#)
- >> [Paper Handling Difficulties](#)
- >> [Printing Received Faxes \(MFC models\)](#)







### Printing Difficulties

Difficulties	Suggestions
No printout	<p>Check that the correct printer driver has been installed and selected.</p> <p>Check to see if the machine's display is showing an error message. See <i>Related Information: Error and Maintenance Messages</i>.</p> <p>Check that the machine is online:</p> <ul style="list-style-type: none"> <li>• Windows Server 2008 Click  (Start) &gt; Control Panel &gt; Hardware and Sound &gt; Printers. Right-click <b>Brother MFC-XXXX Printer</b> (where XXXX is your model name). Make sure <b>Use Printer Online</b> is not listed. If it is listed, click this option to set the driver Online.</li> <li>• Windows 7 and Windows Server 2008 R2 Click  (Start) &gt; Devices and Printers. Right-click <b>Brother MFC-XXXX Printer</b> (where XXXX is your model name) and click <b>See what's printing</b>. If printer driver options appear, select your printer driver. Click <b>Printer</b> in the menu bar. Make sure <b>Use Printer Offline</b> is not selected.</li> <li>• Windows 8 Move your mouse to the lower right corner of your desktop. When the menu bar appears, click <b>Settings &gt; Control Panel</b>. In the <b>Hardware and Sound</b> group, click <b>View devices and printers</b>. Right-click the <b>Brother MFC-XXXX Printer</b> (where XXXX is your model name). Click <b>See what's printing</b>. If printer driver options appear, select your printer driver. Click <b>Printer</b> in the menu bar and make sure <b>Use Printer Offline</b> is not selected.</li> <li>• Windows 10 and Windows Server 2016 Click  &gt; <b>Windows System &gt; Control Panel</b>. In the <b>Hardware and Sound</b> group, click <b>View devices and printers</b>. Right-click the <b>Brother MFC-XXXX Printer</b> (where XXXX is your model name). Click <b>See what's printing</b>. If printer driver options appear, select your printer driver. Click <b>Printer</b> in the menu bar and make sure <b>Use Printer Offline</b> is not selected.</li> <li>• Windows Server 2012 Move your mouse to the lower right corner of your desktop. When the menu bar appears, click <b>Settings &gt; Control Panel</b>. In the <b>Hardware</b> group, click <b>View devices and printers</b>. Right-click the <b>Brother MFC-XXXX Printer</b> (where XXXX is your model name). Click <b>See what's printing</b>. If printer driver options appear, select your printer driver. Click <b>Printer</b> in the menu bar and make sure <b>Use Printer Offline</b> is not selected.</li> <li>• Windows Server 2012 R2 Click <b>Control Panel</b> on the <b>Start</b> screen. In the <b>Hardware</b> group, click <b>View devices and printers</b>. Right-click the <b>Brother MFC-XXXX Printer</b> (where XXXX is your model name). Click <b>See what's printing</b>. If printer driver options appear, select your printer driver. Click <b>Printer</b> in the menu bar and make sure <b>Use Printer Offline</b> is not selected.</li> </ul> <p>One or more ink cartridges have reached the end of their life. See <i>Related Information: Replace the Ink Cartridges</i>.</p>

Difficulties	Suggestions
	<p>If old, unprinted data remains in the printer driver spooler, it will prevent new print jobs from printing. Open the printer icon and delete all data as follows:</p> <ul style="list-style-type: none"> <li>• Windows Server 2008 Click  (<b>Start</b>) &gt; <b>Control Panel</b> &gt; <b>Hardware and Sound</b> &gt; <b>Printers</b>.</li> <li>• Windows 7 and Windows Server 2008 R2 Click  (<b>Start</b>) &gt; <b>Devices and Printers</b> &gt; <b>Printers and Faxes</b>.</li> <li>• Windows 8 Move your mouse to the lower right corner of your desktop. When the menu bar appears, click <b>Settings</b> &gt; <b>Control Panel</b>. In the <b>Hardware and Sound</b> group, click <b>View devices and printers</b> &gt; <b>Printers</b>.</li> <li>• Windows 10 and Windows Server 2016 Click  &gt; <b>Windows System</b> &gt; <b>Control Panel</b>. In the <b>Hardware and Sound</b> group, click <b>View devices and printers</b> &gt; <b>Printers</b>.</li> <li>• Windows Server 2012 Move your mouse to the lower right corner of your desktop. When the menu bar appears, click <b>Settings</b> &gt; <b>Control Panel</b>. In the <b>Hardware</b> group, click <b>View devices and printers</b> &gt; <b>Printers</b>.</li> <li>• Windows Server 2012 R2 Click <b>Control Panel</b> on the <b>Start</b> screen. In the <b>Hardware</b> group, click <b>View devices and printers</b> &gt; <b>Printers</b>.</li> <li>• Mac Click the <b>System Preferences</b> &gt; <b>Printers &amp; Scanners</b>.</li> </ul>
The headers or footers appear when the document is displayed on the screen but do not appear when the document is printed.	There is an unprintable area on the top and bottom of the page. Adjust the top and bottom margins in your document to allow for this. See <i>Related Information: Unprintable Area</i> .
Cannot perform 'Page Layout' printing.	Check that the paper size setting in the application and in the printer driver are the same.
Print speed is too slow.	<p>Try changing the printer driver setting. The highest resolution needs longer data processing, sending and printing time. Try the other quality settings in the printer driver as follows:</p> <ul style="list-style-type: none"> <li>• Windows In the printer driver, clear the <b>Colour Enhancement</b> check box on the <b>Advanced</b> tab.</li> <li>• Mac In the printer driver, select <b>Color Settings</b>, click <b>Advanced Color Settings</b>, and make sure you clear the <b>Color Enhancement</b> check box.</li> </ul> <p>Turn the Borderless feature off. Borderless printing is slower than normal printing. See <i>Related Information: Print Settings (Windows) or Print a Photo (Mac)</i>.</p> <p>Turn the Quiet Mode setting off. Print speed is slower in Quiet Mode. See <i>Related Information: Reduce Printing Noise</i>.</p>

## Print Quality Difficulties

Difficulties	Suggestions
Poor print quality	<p>Check the print quality. See <i>Related Information: Check the Print Quality</i>.</p> <p>Make sure the Media Type setting in the printer driver or the Paper Type setting in the machine's menu matches the type of paper you are using. See <i>Related Information: Change the Paper Size and Paper Type</i>.</p>

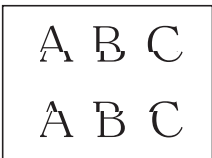
Difficulties	Suggestions
	<p>See <i>Related Information: Print Settings (Windows) or Print Options (Mac)</i>.</p> <p>Make sure your ink cartridges are fresh. The following may cause ink to clog:</p> <ul style="list-style-type: none"> <li>• The expiration date written on the cartridge package has passed.</li> <li>• The ink cartridge may not have been stored correctly before use.</li> </ul> <p>Make sure you are using Brother Original ink. Brother does not recommend the use of cartridges other than Brother Original cartridges or the refilling of used cartridges with ink from other sources.</p> <p>Make sure you are using one of the recommended types of paper. See <i>Related Information: Acceptable Paper and Other Print Media</i>.</p> <p>The recommended environment for your machine is between 20 °C to 33 °C.</p>
<p>White lines appear in text or graphics.</p> 	<p>Clean the print head. See <i>Related Information: Clean the Print Head from Your Brother Machine</i>.</p> <p>See <i>Related Information: Clean the Print Head from Your Computer (Windows) or Clean the Print Head from Your Computer (Mac)</i>.</p> <p>Check and adjust the paper feed. See <i>Related Information: Correct the Paper Feed to Clear Vertical Lines</i>.</p> <p>Make sure you are using Brother Original ink.</p> <p>Try using the recommended types of paper. See <i>Related Information: Acceptable Paper and Other Print Media</i>.</p> <p>To prolong print head life, provide the best ink cartridge economy and maintain print quality, we do not recommend frequently unplugging the machine and/or leaving the machine unplugged for extended periods of time. We recommend using  to power down the machine. Using  allows minimal power to the machine, resulting in periodic, but less frequent, cleaning of the print head.</p>
<p>Dark lines appear at regular intervals.</p> 	<p>Check and adjust the paper feed. See <i>Related Information: Correct the Paper Feed to Clear Vertical Lines</i>.</p>
<p>The machine prints blank pages.</p>	<p>Check the print quality. See <i>Related Information: Check the Print Quality</i>.</p> <p>Make sure you are using Brother Original ink.</p> <p>To prolong print head life, provide the best ink cartridge economy and maintain print quality, we do not recommend frequently unplugging the machine and/or leaving the machine unplugged for extended periods of time. We recommend using  to power down the machine. Using  allows minimal power to the machine, resulting in periodic, but less frequent, cleaning of the print head.</p>
<p>Characters and lines are blurred.</p> 	<p>Check the printing alignment. See <i>Related Information: Check the Print Alignment from Your Brother Machine</i>.</p> <p>Change the print setting options. See <i>Related Information: Change the Print Setting Options When Having Printing Problems</i>.</p>
<p>Printed text or images are skewed.</p>	<p>Make sure the paper is loaded correctly in the paper tray and the paper guides are adjusted correctly. See <i>Related Information: Load Paper</i>.</p>

Difficulties	Suggestions
	Make sure the Jam Clear Cover is closed correctly.
Smudge or stain at the top centre of the printed page.	Make sure the paper is not too thick or curled. See <i>Related Information: Acceptable Paper and Other Print Media</i> .
Printing appears dirty or ink seems to run.	Make sure you are using the recommended types of paper. Do not handle the paper until the ink is dry. See <i>Related Information: Acceptable Paper and Other Print Media</i> .
	Make sure the printing surface is face down in the paper tray.
	Make sure you are using Brother Original ink.
	If you are using photo paper, make sure the glossy side of the photo paper is face down in the tray and you have set the correct paper type. If you are printing a photo from your computer, set the Media Type in the printer driver.
Ink is smudged or wet when using glossy photo paper.	Be sure to check the front and back of the paper. Place the glossy surface (printing surface) face down. See <i>Related Information: Change the Paper Size and Paper Type</i> .
	If you use glossy photo paper, make sure the paper type setting is correct.
Stains appear on the reverse side or at the bottom of the page.	Make sure the printer platen is not dirty with ink. See <i>Related Information: Clean the Machine's Printer Platen</i> .
	Make sure you are using Brother Original ink.
	Make sure you are using the paper support flap. See <i>Related Information: Load Paper</i> .
	Make sure the paper feed rollers are not dirty with ink. See <i>Related Information: Clean the Paper Feed Rollers</i> .
The printouts are wrinkled.	<ul style="list-style-type: none"> <li>• Windows In the printer driver, select the <b>Advanced</b> tab, click <b>Other Print Options</b>, and then click <b>Advanced Colour Settings</b>. Clear the <b>Bi-Directional Printing</b> check box.</li> <li>• Mac In the printer driver, select <b>Print Settings</b>, click <b>Advanced</b>, select <b>Other Print Options</b>, and clear the <b>Bi-Directional Printing</b> check box.</li> </ul>
	Make sure you are using Brother Original ink.
	Change the Reduce Smudge option in your printer driver properties or preferences. See <i>Related Information: Prevent Smudged Printouts and Paper Jams (Windows)</i> or <i>Prevent Smudged Printouts and Paper Jams (Mac)</i> .
Smudge or stain on the reverse side of the page when using the automatic 2-sided printing feature.	Change the Reduce Smudge option in your printer driver properties or preferences. See <i>Related Information: Prevent Smudged Printouts and Paper Jams (Windows)</i> or <i>Prevent Smudged Printouts and Paper Jams (Mac)</i> .

## Paper Handling Difficulties

Difficulties	Suggestions
The machine does not feed paper.	Make sure the paper tray is pushed in all the way until it locks into place.
	Make sure the Jam Clear Cover at the back of the machine is closed.
	If the machine's LCD displays a Paper Jam message and you still have a problem, see <i>Related Information: Error and Maintenance Messages</i> .
	If the paper tray is empty, load a new stack of paper into the paper tray.
	If there is paper in the paper tray, make sure it is straight. If the paper is curled, straighten it. Sometimes it is helpful to remove the paper, turn the stack over and put it back in the paper tray.
	Reduce the amount of paper in the paper tray, and then try again.
	Clean the paper pick-up rollers.

Difficulties	Suggestions
	<p>See <i>Related Information: Clean the Paper Pick-up Rollers.</i></p> <p>Make sure that the paper is within specifications for the machine. See <i>Related Information: Paper Weight and Thickness.</i></p>
Photo paper does not feed correctly.	When you print on Brother Photo paper, load one extra sheet of the same photo paper in the paper tray. An extra sheet has been included in the paper package for this purpose.
Machine feeds multiple pages.	<ul style="list-style-type: none"> <li>• Make sure the paper is loaded correctly in the paper tray.</li> <li>• Remove all the paper from the tray and fan the stack of paper well, then put it back in the tray.</li> <li>• Make sure you do not push the paper in too far.</li> </ul> <p>See <i>Related Information: Load Paper.</i></p>
	<p>Make sure the Jam Clear Cover is closed correctly. See <i>Related Information: Printer Jam or Paper Jam.</i></p>
	<p>Make sure the Base Pad in the paper tray is not dirty. See <i>Related Information: Clean the Base Pad.</i></p>
There is a paper jam.	<p>See <i>Related Information: Printer Jam or Paper Jam.</i> Make sure the paper guides are set to the correct paper size.</p>
	<p>Use the jam prevention settings. For copying See <i>Related Information: Change the Print Setting Options When Having Printing Problems.</i> For printing See <i>Related Information: Prevent Smudged Printouts and Paper Jams (Windows) or Prevent Smudged Printouts and Paper Jams (Mac).</i></p>
The paper jams when you use 2-sided copy or 2-sided print.	<p>If paper jams occur frequently during 2-sided copying or 2-sided printing, the paper feed rollers may be stained with ink. Clean the paper feed rollers. See <i>Related Information: Clean the Paper Feed Rollers.</i></p>

## Printing Received Faxes (MFC models)

Difficulties	Suggestions
<ul style="list-style-type: none"> <li>• Condensed print</li> <li>• Horizontal streaks</li> <li>• Top and bottom sentences are cut off</li> <li>• Missing lines</li> </ul>	<p>This is usually caused by a poor telephone connection. Make a copy; if your copy looks good, you probably had a bad connection, with static or interference on the telephone line. Ask the other party to send the fax again.</p>
Black lines when receiving.	<p>The sender's scanner may be dirty. Ask the sender to make a copy to see if the problem is with the sending machine. Try receiving from another fax machine.</p>
Left and right margins are cut off or a single page is printed on two pages.	<p>If the received faxes are divided and printed on two pages or if you get an extra blank page, your paper size setting may not be correct for the paper you are using. See <i>Related Information: Change the Paper Size and Paper Type.</i></p>
	<p>Turn on Auto Reduction. See <i>Related Information: Shrink Page Size of an Oversized Incoming Fax.</i></p>
Received colour fax prints only in monochrome.	<p>Replace the colour ink cartridges that have reached the end of their life, and then ask the other person to send the colour fax again. See <i>Related Information: Replace the Ink Cartridges.</i></p>



## Related Information

- [If You Are Having Difficulty with Your Machine](#)

### Related Topics:

- [Troubleshooting](#)
- [Error and Maintenance Messages](#)
- [Replace the Ink Cartridges](#)
- [Unprintable Area](#)
- [Check the Print Quality](#)
- [Change the Paper Size and Paper Type](#)
- [Acceptable Paper and Other Print Media](#)
- [Clean the Print Head from Your Brother Machine](#)
- [Clean the Print Head from Your Computer \(Windows\)](#)
- [Clean the Print Head from Your Computer \(Mac\)](#)
- [Check the Print Alignment from Your Brother Machine](#)
- [Load Paper](#)
- [Clean the Machine's Printer Platen](#)
- [Clean the Paper Feed Rollers](#)
- [Clean the Paper Pick-up Rollers](#)
- [Printer Jam or Paper Jam](#)
- [Shrink Page Size of an Oversized Incoming Fax](#)
- [Paper Weight and Thickness](#)
- [Print Settings \(Windows\)](#)
- [Print Options \(Mac\)](#)
- [Print a Photo \(Mac\)](#)
- [Prevent Smudged Printouts and Paper Jams \(Windows\)](#)
- [Prevent Smudged Printouts and Paper Jams \(Mac\)](#)
- [Clean the Base Pad](#)
- [Change the Print Setting Options When Having Printing Problems](#)
- [Reduce Printing Noise](#)
- [Correct the Paper Feed to Clear Vertical Lines](#)

## Telephone and Fax Problems

Related Models: MFC-J1300DW

- >> [Telephone Line or Connections](#)
- >> [Handling Incoming Calls](#)
- >> [Receiving Faxes](#)
- >> [Sending Faxes](#)

### Telephone Line or Connections

Difficulties	Suggestions
Dialling does not work. (No dial tone)	<p>Check all line cord connections. Make sure the telephone line cord is plugged into the telephone wall socket and the LINE socket of the machine. If you subscribe to DSL or VoIP services, contact your service provider for connection instructions.</p> <p>If you are using a VoIP system, try changing the VoIP setting to <i>Basic (for VoIP)</i>. This will lower modem speed and turn off Error Correction Mode (ECM). See <i>Related Information: Telephone Line Interference/VoIP</i>.</p> <p>(Available only for some countries.) Change the Tone/Pulse setting. See <i>Related Information: Set Tone or Pulse Dialling Mode</i>.</p> <p>If there is no dial tone, connect a known working telephone and telephone line cord to the socket. Then lift the external telephone's handset and listen for a dial tone. If there is still no dial tone, ask your telephone company to check the line and/or wall socket.</p>
The machine does not answer when called.	<p>Make sure the machine is in the correct receive mode for your setup. See <i>Related Information: Choose the Correct Receive Mode</i>.</p> <p>Check for a dial tone. If possible, call your machine to hear it answer. If there is still no answer, check that the telephone line cord is plugged into the telephone wall socket and the LINE socket of the machine. If there is no ringing when you call your machine, ask your telephone company to check the line.</p>

### Handling Incoming Calls

Difficulties	Suggestions
The machine 'Hears' a voice as a CNG Tone.	<p>If Fax Detect is set to On, your machine is more sensitive to sounds. It may mistakenly interpret certain voices or music on the line as a fax machine calling and respond with fax receiving tones. Deactivate the machine by pressing .</p> <p>Try avoiding this problem by turning Fax Detect to Off. See <i>Related Information: Set Fax Detect</i>.</p>
Sending a Fax Call to the machine.	<p>If you answered on an extension or external telephone, press your Remote Activation Code (the factory setting is *51). If you answered on the external telephone, press the Start button to receive the fax.</p> <p>When your machine answers, hang up.</p>
Custom features on a single line.	<p>If you have Call Waiting, Call Waiting/Caller ID, Caller ID, Voice Mail, an answering machine, an alarm system or other custom feature on a single telephone line with your machine, it may create a problem sending or receiving faxes.</p> <p><b>For Example:</b> If you subscribe to Call Waiting or some other custom service and its signal comes through the line while your machine is sending or receiving a fax, the signal can temporarily interrupt or disrupt the faxes. Brother's ECM (Error Correction Mode) feature should help overcome this problem. This condition is</p>



Difficulties	Suggestions
	related to the telephone system industry and is common to all devices that send and receive information on a single, shared line with custom features. If avoiding a slight interruption is crucial to your business, we recommend using a separate telephone line with no custom features.

## Receiving Faxes

Difficulties	Suggestions
Cannot receive a fax.	<p>Check all line cord connections. Make sure the telephone line cord is plugged into the telephone wall socket and the LINE socket of the machine. If you subscribe to DSL or VoIP services, contact your service provider for connection instructions. If you are using a VoIP system, try changing the VoIP setting to <i>Basic (for VoIP)</i>. This will lower modem speed and turn off Error Correction Mode (ECM).</p> <p>See <i>Related Information: Telephone Line Interference/VoIP</i>.</p> <p>Make sure the machine is in the correct Receive Mode. This is determined by the external devices and telephone subscriber services you have on the same line as the Brother machine.</p> <p>See <i>Related Information: Choose the Correct Receive Mode</i>.</p> <ul style="list-style-type: none"> <li>• If you have a dedicated fax line and want your Brother machine to automatically answer all incoming faxes, you should select Fax only mode.</li> <li>• If your Brother machine shares a line with an external answering machine, you should select the External TAD mode. In External TAD mode, your Brother machine will receive incoming faxes automatically and voice callers will be able to leave a message on your answering machine.</li> <li>• If your Brother machine shares a line with other telephones and you want it to automatically answer all incoming faxes, you should select the Fax/Tel mode. In Fax/Tel mode, your Brother machine will receive faxes automatically and produce a pseudo/double-ring to alert you to answer voice calls.</li> <li>• If you do not want your Brother machine to answer any incoming faxes automatically, you should select the Manual mode. In Manual mode, you must answer every incoming call and activate the machine to receive faxes.</li> </ul> <p>Another device or service at your location may be answering the call before your Brother machine answers. To test this, lower the Ring Delay setting:</p> <ul style="list-style-type: none"> <li>• If the Receive Mode is set to Fax Only or Fax/Tel, reduce the Ring Delay to one ring.</li> </ul> <p>See <i>Related Information: Set the Number of Rings Before the Machine Answers (Ring Delay)</i>.</p> <ul style="list-style-type: none"> <li>• If the Receive Mode is set to External TAD, reduce the number of rings programmed on your answering machine to two.</li> <li>• If the Receive Mode is set to Manual, DO NOT adjust the Ring Delay setting.</li> </ul> <p>Have someone send you a test fax:</p> <ul style="list-style-type: none"> <li>• If you received the test fax successfully, your machine is operating correctly. Remember to reset your Ring Delay or answering machine setting back to your original setting. If receiving problems recur after resetting the Ring Delay, then a person, device, or subscriber service is answering the fax call before the machine has a chance to answer.</li> <li>• If you were not able to receive the fax, then another device or subscriber service may be interfering with your fax reception or there may be a problem with your fax line.</li> </ul> <p>If you are using a telephone answering machine (External TAD mode) on the same line as the Brother machine, make sure your answering machine is set up correctly.</p> <p>See <i>Related Information: Connect an External TAD</i>.</p> <ol style="list-style-type: none"> <li>1. Connect the external TAD as shown in the illustration.</li> </ol> <p>See <i>Related Information: External TAD (Telephone Answering Device)</i>.</p>

Difficulties	Suggestions
	<p>2. Set your answering machine to answer in one or two rings.</p> <p>3. Record the outgoing message on your answering machine.</p> <ul style="list-style-type: none"> <li>• Record five seconds of silence at the beginning of your outgoing message.</li> <li>• Limit your speaking to 20 seconds.</li> <li>• End your outgoing message with your Remote Activation Code for people sending manual faxes. For example: "After the beep, leave a message or press *51 and Start to send a fax."</li> </ul> <p>4. Set your answering machine to answer calls.</p> <p>5. Set your Brother machine's Receive Mode to External TAD. See <i>Related Information: Choose the Correct Receive Mode.</i></p>
	<p>Make sure your Brother machine's Fax Detect feature is turned On. Fax Detect is a feature that allows you to receive a fax even if you answered the call on an external or extension telephone. See <i>Related Information: Set Fax Detect.</i></p>
	<p>If you often get transmission errors due to possible interference on the telephone line or if you are using a VoIP system, try changing the Compatibility setting to <i>Basic(for VoIP)</i>. See <i>Related Information: Telephone Line Interference/VoIP.</i></p>
	<p>If you connect your machine to a PBX or ISDN line, set the menu setting of Telephone Line Type to your telephone line type. See <i>Related Information: Set the Telephone Line Type.</i></p>

## Sending Faxes

Difficulties	Suggestions
Cannot send a fax.	<p>Check all line cord connections. Make sure the telephone line cord is plugged into the telephone wall socket and the LINE socket of the machine. If you subscribe to DSL or VoIP services, contact your service provider for connection instructions.</p> <p>If you are using a VoIP system, try changing the VoIP setting to <i>Basic (for VoIP)</i>. This will lower modem speed and turn off Error Correction Mode (ECM). See <i>Related Information: Telephone Line Interference/VoIP.</i></p>
	<p>Print the Transmission Verification Report and check for an error. See <i>Related Information: Print Reports.</i></p>
	<p>Contact your administrator to check your Secure Function Lock Settings.</p>
	<p>Ask the other party to check that the receiving machine has paper.</p>
Poor sending quality.	<p>Try changing your resolution to Fine or S.Fine. Make a copy to check your machine's scanner operation. If the copy quality is poor, clean the scanner. See <i>Related Information: Clean the Scanner.</i></p>
Transmission Verification Report says RESULT:NG.	<p>There is probably temporary noise or static on the line. Try sending the fax again. If you are sending a PC-Fax message and get RESULT:NG on the Transmission Verification Report, your machine may be out of memory. To free up extra memory, you can turn off Fax Storage, print fax messages in memory or cancel a delayed fax. If the problem continues, ask the telephone company to check your telephone line.</p> <p>See <i>Related Information: Turn Off Memory Receive.</i> See <i>Related Information: Print a Fax Stored in the Machine's Memory.</i> See <i>Related Information: Cancel a Fax in Progress.</i> See <i>Related Information: Check and Cancel a Pending Fax.</i></p>
	<p>If you connect your machine to a PBX or ISDN line, set the menu setting of Telephone Line Type to your telephone line type. See <i>Related Information: Set the Telephone Line Type.</i></p>

Difficulties	Suggestions
	<p>If you often get transmission errors due to possible interference on the telephone line or if you are using a VoIP system, try changing the Compatibility setting to Basic(for VoIP).</p> <p>See <i>Related Information: Telephone Line Interference/VoIP</i>.</p>
Sent faxes are blank.	<p>Make sure you are loading the document correctly.</p> <p>See <i>Related Information: Load Documents in the Automatic Document Feeder (ADF)</i>.</p> <p>See <i>Related Information: Load Documents on the Scanner Glass</i>.</p>
Vertical black lines when sending.	<p>Black vertical lines on faxes you send are typically caused by dirt or correction fluid on the glass strip. Clean the glass strip.</p> <p>See <i>Related Information: Clean the Scanner</i>.</p>



## Related Information

- [If You Are Having Difficulty with Your Machine](#)
  - [Set Dial Tone Detection](#)
  - [Telephone Line Interference/VoIP](#)



### Related Topics:

- [Troubleshooting](#)
- [Set Tone or Pulse Dialling Mode](#)
- [Choose the Correct Receive Mode](#)
- [Set Fax Detect](#)
- [Set the Number of Rings Before the Machine Answers \(Ring Delay\)](#)
- [Connect an External TAD](#)
- [External TAD \(Telephone Answering Device\)](#)
- [Set the Telephone Line Type](#)
- [Print Reports](#)
- [Clean the Scanner](#)
- [Turn Off Memory Receive](#)
- [Print a Fax Stored in the Machine's Memory](#)
- [Cancel a Fax in Progress](#)
- [Check and Cancel a Pending Fax](#)
- [Load Documents in the Automatic Document Feeder \(ADF\)](#)
- [Load Documents on the Scanner Glass](#)

## Set Dial Tone Detection

Related Models: MFC-J1300DW

Setting the Dial Tone to [Detection] will shorten the Dial Tone detect pause.

1. Press  [Settings] > [All Settings] > [Initial Setup] > [Dial Tone].
2. Press [Detection] or [No Detection].
3. Press .





### Related Information

- [Telephone and Fax Problems](#)

## Telephone Line Interference/VoIP

**Related Models:** MFC-J1300DW

If you are having problems sending or receiving a fax due to possible interference on the telephone line or if you are using a VoIP system, we recommend changing the modem speed to minimise errors in fax operations.

1. Press  [Settings] > [All Settings] > [Initial Setup] > [Compatibility].
2. Press the option you want.
  - [Basic (for VoIP)] reduces the modem speed to 9,600 bps and turns off colour fax receiving and Error Correction Mode (ECM), except for colour fax-sending. Unless interference is a recurring problem on your telephone line, you may prefer to use it only when needed.  
To improve compatibility with most VoIP services, Brother recommends changing the compatibility setting to [Basic (for VoIP)].
  - [Normal] sets the modem speed at 14,400 bps.
3. Press .



- 
- VoIP (Voice over IP) is a type of phone system that uses an Internet connection, rather than a traditional phone line.
- 



### Related Information

- [Telephone and Fax Problems](#)

#### Related Topics:

- [Voice Over Internet Protocol \(VoIP/Telephone Line Interference\)](#)
  - [Error and Maintenance Messages](#)
-

## Other Problems

- >> Copying Difficulties
- >> Scanning Difficulties
- >> PhotoCapture Center Difficulties
- >> Software Difficulties

### Copying Difficulties

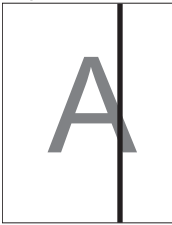
Difficulties	Suggestions
Cannot make a copy.	Contact your administrator to check your Secure Function Lock Settings.
Black lines or streaks appear in copies. 	Black lines on copies are typically caused by dirt or correction fluid on the glass strip. Clean the glass strip, scanner glass, and the white bar and white plastic above them. <i>See Related Information: Clean the Scanner.</i>
Black marks or spots appear in copies.	Black marks or spots on copies are typically caused by dirt or correction fluid on the scanner glass. Clean the scanner glass and white plastic above it. <i>See Related Information: Clean the Scanner.</i>
Copies are blank.	Make sure you are loading the document correctly. <i>See Related Information: Load Documents in the Automatic Document Feeder (ADF).</i> <i>See Related Information: Load Documents on the Scanner Glass.</i>
Poor copy results when using the ADF.	Try using the scanner glass. <i>See Related Information: Load Documents on the Scanner Glass.</i>
Fit to Page does not work correctly.	Make sure the document is not skewed on the scanner glass. Reposition the document and try again.
Smudge or stain on the reverse side of the page when using the automatic 2-sided copy feature.	Change the print setting options. <i>See Related Information: Change the Print Setting Options When Having Printing Problems.</i>

### Scanning Difficulties

Difficulties	Suggestions
TWAIN or WIA errors appear when starting to scan. (Windows)	Make sure the Brother TWAIN or WIA driver is selected as the primary source in your scanning application. For example, in Nuance™ PaperPort™ 14SE, click <b>Desktop &gt; Scan Settings &gt; Select</b> to choose the Brother TWAIN/WIA driver.
OCR does not work.	Try increasing the scanning resolution.
Poor scanning results when using the ADF. (Black lines appear in the scanned data.)	Clean the white bar and the glass strip underneath it. <i>See Related Information: Clean the Scanner.</i>
	Try using the scanner glass. <i>See Related Information: Load Documents on the Scanner Glass.</i>

## PhotoCapture Center Difficulties

Difficulties	Suggestions
Removable Disk does not work correctly.	Make sure the Removable Disk function is set to on. If the problem continues, make the following steps: <ol style="list-style-type: none"><li>1. Take out the memory card or USB Flash drive and put it back in again.</li><li>2. If you have tried "Eject" from within Windows, take out the memory card or USB Flash drive before you continue.</li><li>3. If an error message appears when you try to eject the memory card or USB Flash drive, it means the card is being accessed. Wait a while, and then try again.</li><li>4. If all of the above do not work, turn off your computer and machine, and then turn them on again.</li></ol>
Cannot access Removable Disk from the computer.	Make sure the Removable Disk function is set to on and you have correctly inserted the memory card or USB Flash drive.
Part of my photo is missing when printed.	Make sure Borderless printing and Cropping are turned off. See <i>Related Information: Print Borderless Photos from Media.</i> See <i>Related Information: Print Photos with Auto Cropping.</i>

## Software Difficulties

Difficulties	Suggestions
Cannot print.	Uninstall and reinstall the Brother driver.
"Device Busy" appears on the computer screen.	Make sure the machine is not showing an error message on the machine's display.

## ✓ Related Information

- [If You Are Having Difficulty with Your Machine](#)

### Related Topics:

- [Troubleshooting](#)
- [Clean the Scanner](#)
- [Correct the Paper Feed to Clear Vertical Lines](#)
- [Load Documents in the Automatic Document Feeder \(ADF\)](#)
- [Load Documents on the Scanner Glass](#)
- [Print Borderless Photos from Media](#)
- [Print Photos with Auto Cropping](#)
- [Change the Print Setting Options When Having Printing Problems](#)

## Network Problems

- [Use the Network Connection Repair Tool \(Windows\)](#)
- [Where Can I Find My Brother Machine's Network Settings?](#)
- [I Cannot Complete the Wireless Network Setup Configuration](#)
- [My Brother Machine Cannot Print, Scan, or PC-FAX Receive over the Network](#)
- [I Want to Check that My Network Devices are Working Correctly](#)
- [Troubleshooting](#)





## Use the Network Connection Repair Tool (Windows)

Use the Network Connection Repair Tool to fix the Brother machine's network settings. It will assign the correct IP address and Subnet Mask.

- Windows 7/Windows 8/Windows 10  
You must log on with Administrator rights.
- Make sure the Brother machine is turned on and is connected to the same network as your computer.

1. Do one of the following:

Option	Description
Windows 7	Click  ( <b>Start</b> ) > <b>All Programs</b> > <b>Brother</b> > <b>Brother Utilities</b> .  Click the drop-down list and select your model name (if not already selected). Click <b>Tools</b> in the left navigation bar, and then click <b>Network Connection Repair Tool</b> .
Windows 8/ Windows 10	Launch  ( <b>Brother Utilities</b> ), and then click the drop-down list and select your model name (if not already selected). Click <b>Tools</b> in the left navigation bar, and then click <b>Network Connection Repair Tool</b> .



If the **User Account Control** screen appears, click **Yes**.

2. Follow the on-screen instructions.
3. Check the diagnosis by printing the Network Configuration Report.



The Network Connection Repair Tool will start automatically if you select the **Enable Connection Repair Tool** option in the Status Monitor. Right-click the Status Monitor screen, and then click **Other Settings** > **Enable Connection Repair Tool**. This is not recommended when your network administrator has set the IP address to Static, since it will automatically change the IP address.

If the correct IP address and the Subnet Mask are still not assigned even after using the Network Connection Repair Tool, ask your network administrator for this information.



### Related Information

- [Network Problems](#)

#### Related Topics:

- [Print the Network Configuration Report](#)
- [My Brother Machine Cannot Print, Scan, or PC-FAX Receive over the Network](#)
- [I Want to Check that My Network Devices are Working Correctly](#)

## **Where Can I Find My Brother Machine's Network Settings?**

- [Change Machine Settings from Your Computer](#)
- [Print the Network Configuration Report](#)

## I Cannot Complete the Wireless Network Setup Configuration

Turn your wireless router off and back on. Then try to configure the wireless settings again. If you are unable to resolve the problem, follow the instructions below:

Investigate the problem using the WLAN Report.

Cause	Action	Interface
Your security settings (SSID/ Network Key) are not correct.	<ul style="list-style-type: none"> <li>• Confirm the security settings using <b>Wireless Setup Helper</b>. For more information and to download the utility, go to your model's <b>Downloads</b> page on the Brother Solutions Center at <a href="http://support.brother.com">support.brother.com</a>.</li> <li>• Select and confirm that you are using the correct security settings.                             <ul style="list-style-type: none"> <li>- See the instructions supplied with your wireless LAN access point/router for information on how to find the security settings.</li> <li>- The manufacturer's name or model number of the wireless LAN access point/router may be used as the default security settings.</li> <li>- Consult with the access point/router manufacturer, your Internet provider, or network administrator.</li> </ul> </li> </ul>	Wireless
Your Brother machine's MAC address is not allowed.	Confirm that the Brother machine's MAC Address is allowed in the filter. You can find the MAC Address on your Brother machine's control panel.	Wireless
Your wireless LAN access point/router is in stealth mode (not broadcasting the SSID).	<ul style="list-style-type: none"> <li>• Enter the correct SSID name or Network Key manually.</li> <li>• Check the SSID name or the Network Key in the instructions supplied with your wireless LAN access point/router and reconfigure the wireless network setup.</li> </ul>	Wireless
Your security settings (SSID/ password) are not correct.	<ul style="list-style-type: none"> <li>• Confirm the SSID and password.                             <ul style="list-style-type: none"> <li>- When you are configuring the network manually, the SSID and password are displayed on your Brother machine. If your mobile device supports the manual configuration, the SSID and password will be displayed on your mobile device's screen.</li> </ul> </li> </ul>	Wi-Fi Direct
You are using Android™ 4.0.	If your mobile device disconnects (approximately six minutes after using Wi-Fi Direct), try the one-push configuration using WPS (recommended) and set the Brother machine as a G/O.	Wi-Fi Direct
Your Brother machine is placed too far from your mobile device.	Move your Brother machine within about 3.3 feet (1 metre) of the mobile device when you configure the Wi-Fi Direct network settings.	Wi-Fi Direct
There are some obstructions (walls or furniture, for example) between your machine and the mobile device.	Move your Brother machine to an obstruction-free area.	Wi-Fi Direct
There is a wireless computer, Bluetooth®-supported device, microwave oven, or digital cordless phone near the Brother machine or the mobile device.	Move other devices away from the Brother machine or the mobile device.	Wi-Fi Direct
If you have checked and tried all of the above, but still cannot complete the Wi-Fi	<ul style="list-style-type: none"> <li>• Turn your Brother machine off and back on. Then try to configure the Wi-Fi Direct settings again.</li> </ul>	Wi-Fi Direct

---

Cause	Action	Interface
Direct configuration, do the following:	<ul style="list-style-type: none"><li data-bbox="496 170 1230 264">• If you are using your Brother machine as a client, confirm how many devices are allowed in the current Wi-Fi Direct network, and then check how many devices are connected.</li></ul>	

### For Windows

If your wireless connection has been interrupted, and you have checked and tried all of the above, we recommend using the Network Connection Repair Tool.



### Related Information



- [Network Problems](#)

#### Related Topics:

- [Configure Your Machine for a Wireless Network When the SSID is Not Broadcast](#)
  - [Use Wi-Fi Direct®](#)
-

## My Brother Machine Cannot Print, Scan, or PC-FAX Receive over the Network

Cause	Action	Interface
Your security software blocks your machine's access to the network. (The Network scanning feature does not work. )	<ul style="list-style-type: none"> <li>• Windows Configure the third-party Security/Firewall Software to allow Network scanning. To add port 54925 for Network scanning, type the information below:                             <ul style="list-style-type: none"> <li>- In <b>Name</b>: Type any description, for example Brother NetScan.</li> <li>- In <b>Port number</b>: Type 54925.</li> <li>- In <b>Protocol</b>: UDP is selected.</li> </ul>                             See the instruction manual that came with your third-party Security/Firewall Software or contact the software manufacturer.                         </li> <li>• Mac (Brother iPrint&amp;Scan) In the <b>Finder</b> menu bar, click <b>Go &gt; Applications</b>, and then double-click the Brother iPrint&amp;Scan icon. The Brother iPrint&amp;Scan window appears. Click the <b>Select your Machine</b> button, and then follow the on-screen instructions to reselect your network machine. (TWAIN driver) In the <b>Finder</b> menu bar, click <b>Go &gt; Applications &gt; Brother &gt; TWAIN Driver Utility</b>, and then double-click the Device Selector icon. The Device Selector window appears. Reselect your network machine, make sure <b>Status</b> is <b>idle</b>, and then click <b>OK</b>.</li> </ul>	Wired/Wireless
Your security software blocks your machine's access to the network. (The network PC-Fax Receive feature does not work.) (Windows)	<p>Set the third-party Security/Firewall Software to allow PC-FAX Rx. To add port 54926 for Network PC-FAX Rx, type the information below:</p> <ul style="list-style-type: none"> <li>• In <b>Name</b>: Type any description, for example Brother PC-FAX Rx.</li> <li>• In <b>Port number</b>: Type 54926.</li> <li>• In <b>Protocol</b>: UDP is selected.</li> </ul> <p>See the instruction manual that came with your third-party Security/Firewall Software or contact the software manufacturer.</p>	Wired/Wireless
Your security software blocks your machine's access to the network.	<p>Some security software might block access without showing a security alert dialog box even after successful installation.</p> <p>To allow access, see the instructions for your security software or ask the software manufacturer.</p>	Wired/Wireless
Your Brother machine was not assigned an available IP address.	<ul style="list-style-type: none"> <li>• Confirm the IP address and the Subnet Mask. Verify that both the IP addresses and Subnet Masks of your computer and the Brother machine are correct and located on the same network. For more information about how to verify the IP address and the Subnet Mask, ask your network administrator.</li> <li>• Windows Confirm the IP address and the Subnet Mask using the Network Connection Repair Tool.</li> <li>• Mac</li> </ul>	Wired/Wireless

Cause	Action	Interface
	<p>Check your network devices using the ping command. For more information on how to confirm your network settings, see <i>Related Information: Check Network Devices Using the Ping Command</i>.</p>	
The failed print job is still in your computer's print queue.	<ul style="list-style-type: none"> <li>• If the failed print job is still in your computer's print queue, delete it.</li> <li>• Otherwise, double-click the printer icon in the following folder and cancel all documents: <ul style="list-style-type: none"> <li>- Windows 7 <p>Click  <b>(Start) &gt; Devices and Printers</b>.</p> </li> <li>- Windows 8 <p>Move your mouse to the lower right corner of your desktop. When the menu bar appears, click <b>Settings &gt; Control Panel</b>. In the <b>Hardware and Sound</b> group, click <b>View devices and printers</b>.</p> </li> <li>- Windows 10 and Windows Server 2016 <p>Click  <b>&gt; Windows System &gt; Control Panel</b>. In the <b>Hardware and Sound</b> group, click <b>View devices and printers</b>.</p> </li> <li>- Windows Server 2008 <p>Click <b>Start &gt; Control Panel &gt; Printers</b>.</p> </li> <li>- Windows Server 2012 <p>Move your mouse to the lower right corner of your desktop. When the menu bar appears, click <b>Settings &gt; Control Panel</b>. In the <b>Hardware</b> group, click <b>View devices and printers &gt; Printers</b>.</p> </li> <li>- Windows Server 2012 R2 <p>Click <b>Control Panel</b> on the <b>Start</b> screen. In the <b>Hardware</b> group, click <b>View devices and printers</b>.</p> </li> <li>- Mac <p>Click <b>System Preferences &gt; Printers &amp; Scanners</b>.</p> </li> </ul> </li> </ul>	Wired/Wireless
Your Brother machine is not connected to the wireless network.	Print the WLAN Report to check the error code on the printed report.	Wireless

If you have checked and tried all of the above, but your Brother machine still cannot print and scan, uninstall the Brother software and drivers and reinstall them.



## Related Information

- [Network Problems](#)

### Related Topics:

- [Print the WLAN Report](#)
- [Use the Network Connection Repair Tool \(Windows\)](#)
- [Wireless LAN Report Error Codes](#)
- [Check Network Devices Using the Ping Command](#)
- [I Want to Check that My Network Devices are Working Correctly](#)

## I Want to Check that My Network Devices are Working Correctly

Check	Action	Interface
Check that your Brother machine, access point/router, or network hub is turned on.	<p><b>Check the following:</b></p> <ul style="list-style-type: none"> <li>The power cord is connected correctly and the Brother machine is turned on.</li> <li>The access point/router or hub is turned on and its link button is blinking.</li> <li>All protective packaging has been removed from the machine.</li> <li>The ink cartridges are installed correctly.</li> <li>The Scanner Cover and the Jam Clear Cover are fully closed.</li> <li>Paper is inserted correctly in the paper tray.</li> <li>(For wired networks) A network cable is securely connected to the Brother machine and to the router or hub.</li> </ul>	Wired/Wireless
Check that you can "ping" the Brother machine from your computer.	<p>Ping the Brother machine from your computer using the IP address or the node name in the Windows command prompt or Mac Terminal application:</p> <p>ping &lt;ipaddress&gt; or &lt;nodename&gt;.</p> <ul style="list-style-type: none"> <li>Successful: Your Brother machine is working correctly and connected to the same network as your computer.</li> <li>Unsuccessful: Your Brother machine is not connected to the same network as your computer.</li> </ul> <p>(Windows) Ask the network administrator and use the Network Connection Repair Tool to fix the IP address and the subnet mask.</p> <p>(Mac) Confirm that the IP address and the Subnet Mask are set correctly.</p>	Wired/Wireless
Check that your Brother machine is connected to the wireless network.	Print the WLAN Report to check the error code on the printed report.	Wireless

If you have checked and tried all of the above but you are still having problems, see the instructions supplied with your wireless LAN access point/router to find the SSID and the Network Key information and set them correctly.



### Related Information

- [Network Problems](#)
  - [Check Network Devices Using the Ping Command](#)

#### Related Topics:

- [Print the Network Configuration Report](#)
- [Print the WLAN Report](#)
- [Use the Network Connection Repair Tool \(Windows\)](#)
- [My Brother Machine Cannot Print, Scan, or PC-FAX Receive over the Network](#)
- [Wireless LAN Report Error Codes](#)

## Check Network Devices Using the Ping Command

Check the IP addresses of both your computer and your Brother machine, and then confirm whether the network is operating correctly.

- >> [Configure the IP Address on your computer \(Windows\)](#)
- >> [Configure the IP Address on your computer \(Mac\)](#)
- >> [Configure the IP Address on your Brother machine](#)

### Configure the IP Address on your computer (Windows)

1. Do one of the following:

- Windows 7

Click /(Start) > **All Programs > Accessories > Command Prompt**

- Windows 8

Move your mouse to the lower right corner of your desktop. When the menu bar appears, click **Search > Command Prompt**.

- Windows 10

Click  > **Windows System > Command Prompt**.

- Type "ipconfig" and then press the Enter key on your keyboard.
- Confirm the values for the IPv4 address and subnet mask.
- Type "exit" and then press the Enter key on your keyboard.

### Configure the IP Address on your computer (Mac)

- Select **System Preferences** from the Apple menu.
- Click **Network > Advanced > TCP/IP**
- Confirm the values for the IPv4 address and subnet mask.

### Configure the IP Address on your Brother machine

Print the Network Configuration Report, and confirm the values for the IP address and subnet mask.

```
<IP Settings >
IP Address      192.168.11.250      (set manually)
Subnet Mask     255.255.255.0
IP Gateway      192.168.100.200
Boot Method     STATIC
Boot Tries      3
IP Filter       Disabled
```

Check the IP addresses for both your computer and your Brother machine. Confirm that the network address portions are the same. For example, if the subnet mask is "255.255.255.0", it is normal for only the host address portions to be different.

	Network Address	Host Address	
IP Address	192.168.100.	250	Set the final number, which corresponds to "0" in the subnet mask, to 1–254.
Subnet Mask	255.255.255.	0	Usually, there are no problems when the subnet mask is "255.255.255.0". Use the same value for all of your computers.

### Related Information

- [I Want to Check that My Network Devices are Working Correctly](#)



---

**Related Topics:**

- [My Brother Machine Cannot Print, Scan, or PC-FAX Receive over the Network](#)
-

## Google Cloud Print Problems

Difficulty	Suggestions
My Brother machine is not displayed in the printer list.	Make sure your machine is turned on.
	Confirm that Google Cloud Print™ is enabled.
	Confirm that your machine is registered with Google Cloud Print™. If it is not registered, try to register again.
I cannot print.	Make sure your machine is turned on.
	Confirm your network settings. See <i>Related Information</i> .
	Certain files may not be printable, or may not appear exactly as they are displayed.
I cannot register my Brother machine with Google Cloud Print™.	Make sure your machine is connected to a network with Internet access.
	Verify that the date and time are set correctly on your machine.
I do not see a confirmation message on my Brother machine when I try to register with Google Cloud Print™, even after repeating the registration steps.	Make sure your Brother machine is idle while you are registering with Google Cloud Print™.



### Related Information

- [If You Are Having Difficulty with Your Machine](#)

#### Related Topics:

- [Troubleshooting](#)
- [Network Settings for Using Google Cloud Print](#)

## AirPrint Problems

Difficulty	Suggestions
My Brother machine is not displayed in the printer list.	Make sure your Brother machine is turned on.
	Confirm the network settings.
	Move the mobile device closer to the wireless access point/router, or to your Brother machine.
I cannot print.	Make sure your Brother machine is turned on.
	Confirm the network settings.
I am trying to print a multiple-page document from an iOS device, but ONLY the first page is printing.	Make sure you are running the latest OS version. Refer to the following Apple support article for more information about AirPrint: <a href="https://support.apple.com/kb/HT4356">support.apple.com/kb/HT4356</a> .



### Related Information

- [If You Are Having Difficulty with Your Machine](#)

#### Related Topics:

- [Troubleshooting](#)

## Check the Machine Information

Follow these instructions to check your Brother machine's serial number, firmware version, and firmware update.

1. Press  [Settings] > [All Settings] > [Machine Info.].
2. Press one of the following options:

Option	Description
Serial No.	Check your machine's serial number.
Firmware Version	Check your machine's firmware version.
Firmware Update	Update your machine to the latest firmware.
Firmware Auto Check	View firmware information on the Home screen.

3. Press .

### Related Information

- [Troubleshooting](#)

## Reset Your Brother Machine

1. Press  [Settings] > [All Settings] > [Initial Setup] > [Reset].
2. Press the reset option you want to use.
3. Press [OK] for two seconds to reboot the machine.

### Related Information

- [Troubleshooting](#)
  - [Reset Functions Overview](#)

#### Related Topics:

- [Transfer Your Faxes or Fax Journal Report](#)
-

## Reset Functions Overview

The following reset functions are available:

1. [Machine Reset]

You can reset all the machine's settings that you have changed.

The Address Book, Fax Reports, and Call History will remain. (MFC models)

2. [Network]

Reset the print server back to its default factory settings (includes Password and IP Address information).

3. [Address Book & Fax] (MFC models)

Address Book & Fax resets the following settings:

- Address Book and Setup Groups
- Programmed fax jobs in the memory (MFC-J1300DW)  
Delayed Fax and Delayed Batch Transmission
- Station ID  
Name and Number
- Remote Fax Options (MFC-J1300DW)
- Report  
Transmission Verification Report, Address Book and Fax Journal
- History  
Caller ID History and Outgoing Call
- Faxes in memory

4. [All Settings]

Use the Settings Reset function to reset all machine's settings to the settings originally set at the factory.

Brother strongly recommends you perform this operation when you dispose of the machine.



(MFC-J1300DW)

Unplug the interface cable before you select [Network] or [All Settings].



### Related Information

- [Reset Your Brother Machine](#)

#### Related Topics:

- [Transfer Your Faxes or Fax Journal Report](#)

## **Routine Maintenance**

- [Replace the Ink Cartridges](#)
- [Clean Your Brother Machine](#)
- [Check Your Brother Machine](#)
- [Correct the Paper Feed to Clear Vertical Lines](#)
- [Change the Print Setting Options When Having Printing Problems](#)
- [Pack and Ship Your Brother Machine](#)

## Replace the Ink Cartridges

Your Brother machine is equipped with an ink dot counter. The ink dot counter automatically monitors the level of ink in each of the four cartridges. When the machine detects an ink cartridge is running out of ink, the machine will display a message.

The LCD displays which ink cartridge needs replacing. Be sure to follow the LCD prompts to replace the ink cartridges in the correct order.

Even though the machine tells you to replace an ink cartridge, there will be a small amount of ink left in the ink cartridge.

### **CAUTION**

If the ink gets into your eye, rinse it with water immediately. If left as is, it may cause redness or mild inflammation of the eye. In case of any abnormality, consult with your doctor.

### **IMPORTANT**

Brother strongly recommends that you do not refill the ink cartridges provided with your machine. We also strongly recommend that you continue to use only Brother Original replacement ink cartridges. Use or attempted use of potentially incompatible ink and/or cartridges in the Brother machine may cause damage to the machine and/or may result in unsatisfactory print quality. Our warranty coverage does not apply to any problem that is caused by the use of unauthorised third-party ink and/or cartridges. To protect your investment and obtain premium performance from the Brother machine, we strongly recommend the use of Brother Original ink cartridges.

1. Open the ink cartridge cover (1).

If one or more of the ink cartridges needs replacing, the LCD displays [B&W Print Only] or [Replace Ink].

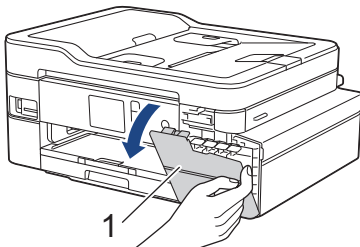

If the black ink cartridge is empty, the only message that will appear is [Replace Ink]. You must replace the black ink cartridge.

2. Press the lock release lever to release the cartridge colour indicated on the LCD and remove the cartridge from the machine, as shown in the illustration.

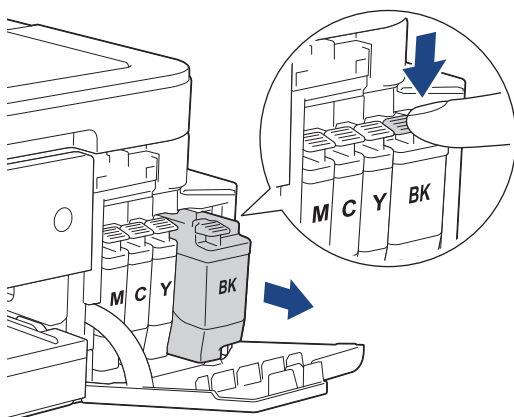



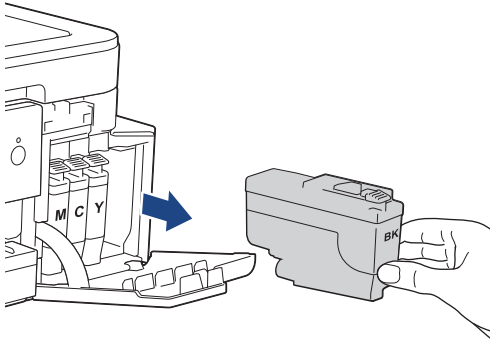

3. Open the new ink cartridge bag for the colour indicated on the LCD, and take out the ink cartridge.

### IMPORTANT

- DO NOT touch the ink cartridge in the area indicated (1); this can prevent the machine from detecting the cartridge.

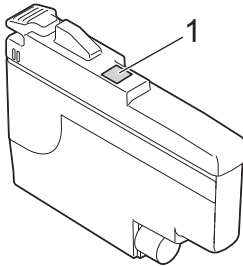

- Quickly shake just the **black** ink cartridge horizontally 15 times as shown, before inserting it into the machine.

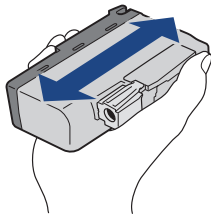

4. Insert the ink cartridge in the direction of the arrow on the label.  
Each colour has its own correct position.

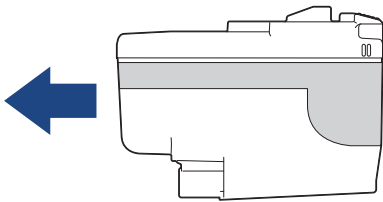

5. Gently push the area marked "PUSH" until the ink cartridge locks into place, and then close the ink cartridge cover.

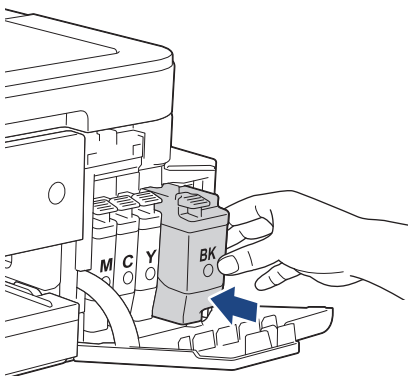

---

The machine automatically resets the ink dot counter.



---

If the LCD displays [No Ink Cartridge] or [Cannot Detect] after you install the ink cartridge, check that the ink cartridge is installed correctly. Remove the ink cartridge and reinstall it slowly until it locks into place.

---

## IMPORTANT

- DO NOT shake the ink cartridges. If ink stains your skin or clothing, wash with soap or detergent at once.
- DO NOT take out ink cartridges if you do not need to replace them; the machine will not know the quantity of ink left in the cartridge.
- DO NOT touch the cartridge insertion slots; the ink may stain your skin.
- If you mix the colours by installing an ink cartridge in the wrong position, the LCD shows [Wrong Ink Colour].

Check which ink cartridges are not matched by colour to their ink cartridge positions and move them to their proper positions.

- Use unopened ink cartridges by the expiration date written on the cartridge package.
- DO NOT dismantle or tamper with the ink cartridge; this can cause the ink to leak out of the cartridge.



## Related Information

- [Routine Maintenance](#)

### Related Topics:

- [Error and Maintenance Messages](#)
  - [Paper Handling and Printing Problems](#)
  - [Pack and Ship Your Brother Machine](#)
-

## Clean Your Brother Machine

- [Clean the Scanner](#)
- [Clean the Print Head from Your Brother Machine](#)
- [Clean the Print Head from Your Computer \(Windows\)](#)
- [Clean the Print Head from Your Computer \(Mac\)](#)
- [Clean the Machine's LCD](#)
- [Clean the Outside of the Machine](#)
- [Clean the Machine's Printer Platen](#)
- [Clean the Paper Feed Rollers](#)
- [Clean the Base Pad](#)
- [Clean the Paper Pick-up Rollers](#)

## Clean the Scanner

1. Unplug the machine from the electrical socket.
2. Lift the document cover (1). Clean the scanner glass (2) and the white plastic (3) with a soft lint-free cloth moistened with water.

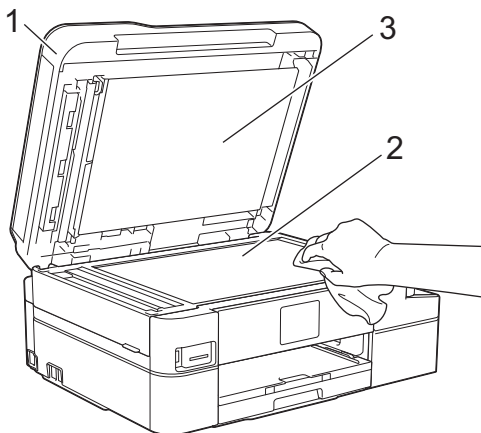

3. In the ADF unit, clean the white bar (1) and the glass strip (2) with a lint-free cloth moistened with water.

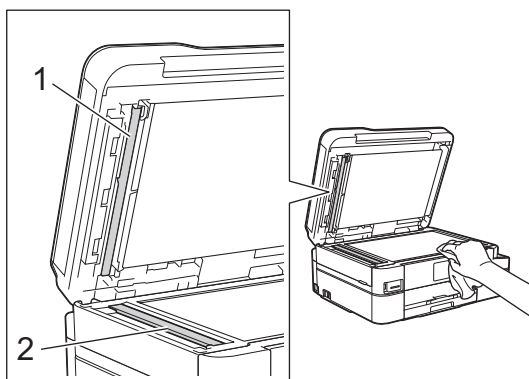

In addition to cleaning the scanner glass and glass strip with a soft lint-free cloth moistened with water, run your fingertip over the glass to see if you can feel anything on it. If you feel dirt or debris, clean the glass again concentrating on that area. You may need to repeat the cleaning process three or four times. To test, make a copy after each cleaning attempt.



When there is a spot of dirt or correction fluid on the glass strip, the printed sample shows a vertical line.



After the glass strip is cleaned, the vertical line is gone.

### ✓ Related Information

- [Clean Your Brother Machine](#)

---

**Related Topics:**

- [Telephone and Fax Problems](#)
  - [Other Problems](#)
-

## Clean the Print Head from Your Brother Machine

To maintain good print quality, the machine automatically cleans the print head when needed. If there is a print quality problem, start the cleaning process manually.

- Clean the print head if there is a horizontal line or a blank space in the text or graphics on printed pages. Depending on the problem colour, select to clean Black only, three colours at a time (Yellow/Cyan/Magenta), or all four colours at once.
- Cleaning the print head consumes ink.
- Cleaning too often uses ink unnecessarily.

### IMPORTANT

DO NOT touch the print head. Touching the print head may cause permanent damage and may void the print head's warranty.

1. Press  [Settings] > [Maintenance] > [Print Head Cleaning].
2. Press [Black only], [Colour only], or [All].
3. Press [Normal], [Strong], or [Strongest].
4. Press [Start].

The machine cleans the print head.



- If you clean the print head and the print has not improved, try installing a new Genuine Brother Brand replacement ink cartridge for each problem colour. Try cleaning the print head again. If the print has not improved, contact Brother customer service or your local Brother dealer.
- You can also clean the print head from your computer.



### Related Information



- [Clean Your Brother Machine](#)

#### Related Topics:

- [Paper Handling and Printing Problems](#)
- [Clean the Print Head from Your Computer \(Windows\)](#)
- [Clean the Print Head from Your Computer \(Mac\)](#)

## Clean the Print Head from Your Computer (Windows)

To maintain good print quality, the machine automatically cleans the print head when needed. If there is a print quality problem, start the cleaning process manually.

- Do one of the following:
  - For Windows Server 2008  
Click  (**Start**) > **Control Panel** > **Hardware and Sound** > **Printers**.
  - For Windows 7 and Windows Server 2008 R2  
Click  (**Start**) > **Devices and Printers**.
  - For Windows 8  
Move your mouse to the lower right corner of your desktop. When the menu bar appears, click **Settings**, and then click **Control Panel**. In the **Hardware and Sound** group, click **View devices and printers**.
  - For Windows Server 2012  
Move your mouse to the lower right corner of your desktop. When the menu bar appears, click **Settings**, and then click **Control Panel**. In the **Hardware** group, click **View devices and printers**.
  - For Windows Server 2012 R2  
Click **Control Panel** on the **Start** screen. In the **Hardware** group, click **View devices and printers**.
  - For Windows 10 and Windows Server 2016  
Click  > **Windows System** > **Control Panel**. In the **Hardware and Sound** group, click **View devices and printers**.
- Right-click the **Brother MFC-XXXX Printer** icon (where XXXX is your model name), and then select **Printing preferences**. If printer driver options appear, select your printer driver.  
The printer driver dialog box appears.
- Click the **Maintenance** tab.
- Select one of the following options:

Option	Description
<b>Check Print Quality...</b>	Use to print the test page and check the print quality.
<b>Print Head Cleaning...</b>	Use to start the cleaning process manually. Select if a line or blank spaces appear in text or graphics on the test page.

- Do one of the following:
  - If you selected the **Check Print Quality...** option, click **Start**.  
The machine prints the test page.
  - If you selected the **Print Head Cleaning...** option, select the **Black only**, **Colour only**, or **All** option for the cleaning type, and then click **Next**.
- Select the **Normal**, **Strong**, or **Strongest** option for the cleaning strength, and then click **Next**.
- Click **Start**.  
The machine starts cleaning.

### Related Information

- [Clean Your Brother Machine](#)

#### Related Topics:

- [Paper Handling and Printing Problems](#)

- 
- Clean the Print Head from Your Brother Machine
-



## Clean the Print Head from Your Computer (Mac)

To maintain good print quality, the machine automatically cleans the print head when needed. If there is a print quality problem, start the cleaning process manually.

1. Select **System Preferences** from the Apple menu.
2. Select **Printers & Scanners**, and then select the machine.
3. Click the **Options & Supplies** button.
4. Click the **Utility** tab, and then click the **Open Printer Utility** button.  
The Status Monitor screen appears.
5. Click the **Control** menu, and then select **Maintenance**.
6. Select one of the following options:

Option	Description
<b>Check Print Quality...</b>	Use to print the test page and check the print quality.
<b>Print Head Cleaning...</b>	Use to start the cleaning process manually. Select if a line or blank spaces appear in text or graphics on the test page.

7. Do one of the following:
  - If you selected the **Check Print Quality...** option, click **Start**.  
The machine prints the test page.
  - If you selected the **Print Head Cleaning...** option, select **Black only**, **Color only**, or **All** option for the cleaning type, and then click **Next**.
8. Select the **Normal**, **Strong**, or **Strongest** option for the cleaning strength, and then click **Next**.
9. Click **Start**.  
The machine starts cleaning.



### Related Information

- [Clean Your Brother Machine](#)

#### Related Topics:

- [Paper Handling and Printing Problems](#)
- [Clean the Print Head from Your Brother Machine](#)

## Clean the Machine's LCD

### IMPORTANT

DO NOT use liquid cleaners (including ethanol).

1. Press and hold down  to turn off the machine. The LCD displays [Shutting Down] for a few seconds before the power goes off.
2. Clean the LCD with a dry, soft lint-free cloth.

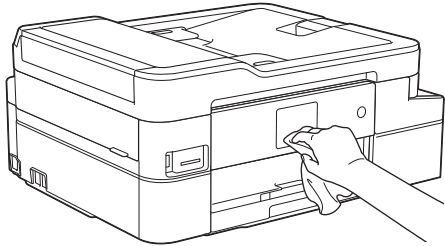

### Related Information

- [Clean Your Brother Machine](#)

## Clean the Outside of the Machine

### IMPORTANT

- Cleaning with volatile liquids such as thinner or benzine will damage the outside surface of the machine.
- DO NOT use cleaning materials that contain ammonia.
- DO NOT use isopropyl alcohol to remove dirt from the control panel. It may crack the panel.

1. If the paper support flap is open, close it, and then close the paper support.
2. Pull the paper tray (1) completely out of the machine.

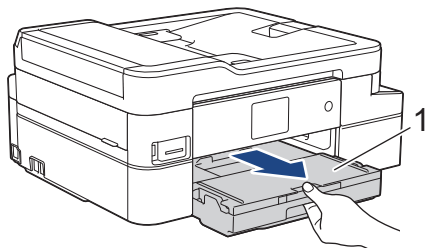

3. Wipe the outside of the machine with a dry, lint-free cloth to remove dust.

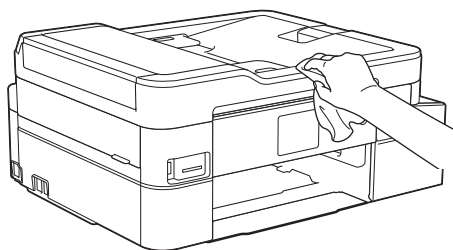

4. Lift the output paper tray cover and remove anything that is stuck inside the paper tray.

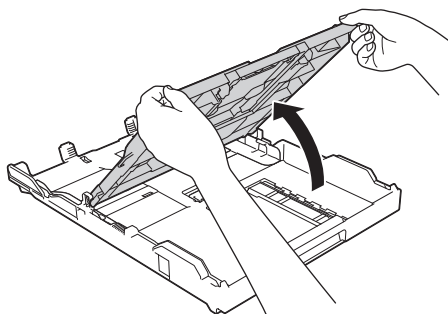

5. Wipe the inside and the outside of the paper tray with a dry, lint-free cloth to remove dust.

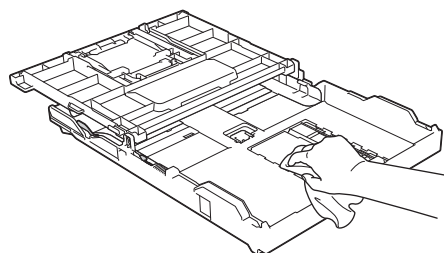

6. Close the output paper tray cover and slowly push the paper tray completely into the machine.



### Related Information

- [Clean Your Brother Machine](#)

## Clean the Machine's Printer Platen

### WARNING

 Be sure to unplug the machine from the electrical socket before cleaning the printer platen to avoid an electrical shock.

1. Using both hands, use the finger holds on each side of the machine to lift the scanner cover into the open position.
2. Clean the machine's printer platen (1) and the area around it, wiping off scattered ink with a dry, soft lint-free cloth.

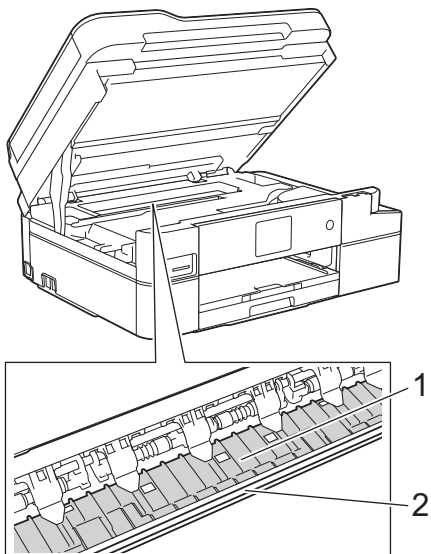

### IMPORTANT

DO NOT touch the encoder strip, the thin strip of plastic that stretches across the width of the machine (2). Doing this may cause damage to the machine.

3. Gently close the scanner cover using both hands.

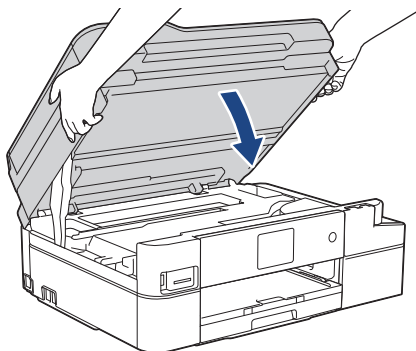

4. Reconnect the power cord.

### Related Information

- [Clean Your Brother Machine](#)

#### Related Topics:

- [Paper Handling and Printing Problems](#)

## Clean the Paper Feed Rollers

If the paper feed rollers are stained with ink or have a buildup of paper dust, it may cause paper feed problems.

1. Unplug the machine from the electrical socket.
2. If the paper support flap is open, close it, and then close the paper support.
3. Pull the paper tray (1) completely out of the machine.

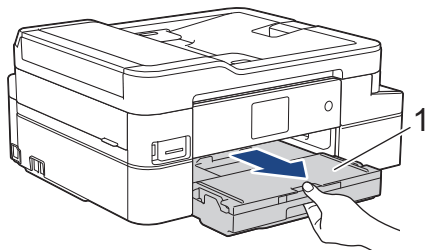

4. Clean the front side of the Paper Feed Rollers (1) with a soft lint-free cloth moistened with water, using a side-to-side motion. After cleaning, wipe the rollers with a dry, soft lint-free cloth to remove all moisture.

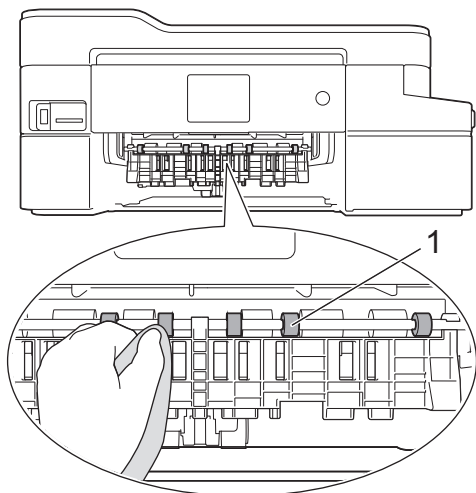

5. Lift the Jam Clear Flap (2), and then clean the back side of the Paper Feed Rollers (1) with a soft lint-free cloth moistened with water. After cleaning, wipe the rollers with a dry, soft lint-free cloth to remove all moisture.

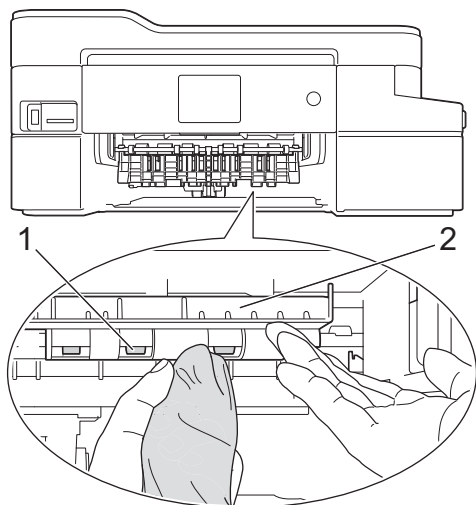

6. Slowly push the paper tray completely into the machine.
7. Reconnect the power cord.



Do not use the machine again until the rollers are dry. Using the machine before the rollers are dry may cause paper feed problems.



---

## Related Information

---

- [Clean Your Brother Machine](#)

### **Related Topics:**

- [Paper Handling and Printing Problems](#)
-

## Clean the Base Pad

Cleaning the Base Pad periodically may prevent the machine from feeding multiple sheets of paper when there are only a few sheets of paper left in the tray.

1. If the paper support flap is open, close it, and then close the paper support.
2. Pull the paper tray (1) completely out of the machine.

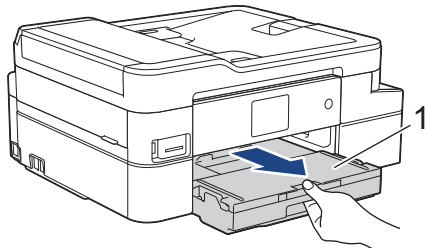

3. Clean the Base Pad (1) with a soft lint-free cloth moistened with water. After cleaning, wipe the pad with a dry, soft lint-free cloth to remove all moisture.

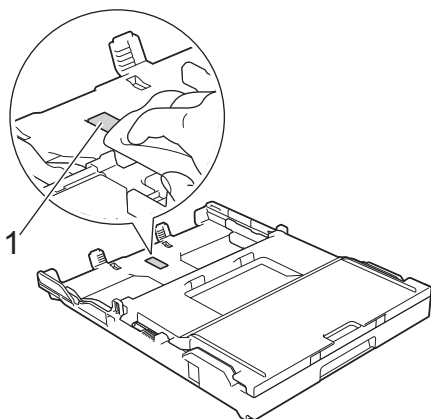

4. Slowly push the paper tray completely into the machine.

### ✓ Related Information

- [Clean Your Brother Machine](#)

#### Related Topics:

- [Paper Handling and Printing Problems](#)

## Clean the Paper Pick-up Rollers

Cleaning the paper pick-up rollers periodically may prevent paper jams by ensuring that paper feeds correctly.

1. Unplug the machine from the electrical socket.
2. If the paper support flap (1) is open, close it, and then close the paper support (2).

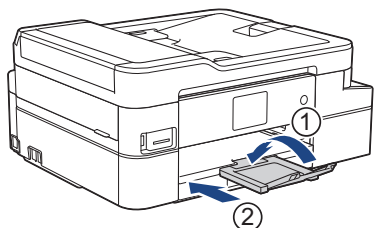

3. Pull the paper tray completely out of the machine.
4. Clean the Paper Pick-up Rollers (1) with a soft lint-free cloth moistened with water. Slowly turn the rollers so that the whole surface is cleaned. After cleaning, wipe the rollers with a dry, soft lint-free cloth to remove all moisture.

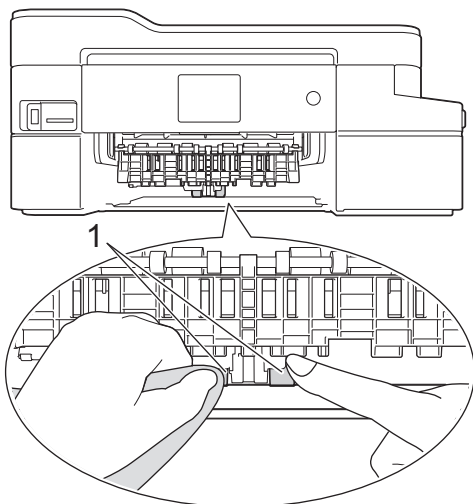

5. Slowly push the paper tray completely into the machine.
6. Reconnect the power cord.

### ✓ Related Information

- [Clean Your Brother Machine](#)

#### Related Topics:

- [Error and Maintenance Messages](#)
- [Paper Handling and Printing Problems](#)





## Check Your Brother Machine

- [Check the Print Quality](#)
- [Check the Print Alignment from Your Brother Machine](#)
- [Check the Ink Volume \(Page Gauge\)](#)
- [Monitor Machine Status from Your Computer \(Windows\)](#)
- [Monitor Machine Status from Your Computer \(Mac\)](#)

## Check the Print Quality

If faded or streaked colours and text appear or if text is missing on your printouts, the print head nozzles may be clogged. Print the Print Quality Check Sheet and look at the nozzle check pattern.

1. Press  [Settings] > [Maintenance] > [Improve Print Quality] > [Check Print Quality].
2. Press [Start].  
The machine prints the Print Quality Check Sheet.
3. Check the quality of the four colour blocks on the sheet.
4. The touchscreen asks about the print quality. Do one of the following:
  - If all lines are clear and visible, press [No], and then press  to finish the Print Quality check.
  - If lines are missing (see **Poor**, as follows), press [Yes].

### OK

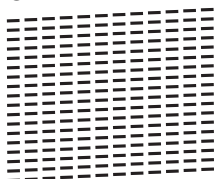

### Poor

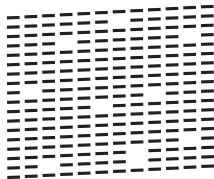

5. The touchscreen asks you to check the print quality of each colour. Press the number of the pattern (1–4) that most closely matches the printing result.
6. Do one of the following:
  - If print head cleaning is needed, press [Start] to start the cleaning procedure.
  - If print head cleaning is not needed, the Maintenance screen reappears on the touchscreen. Press .
7. After the cleaning procedure is finished, the touchscreen asks if you want to print the Print Quality Check Sheet again. Press [Yes], and then press [Start].  
The machine prints the Print Quality Check Sheet again. Check the quality of the four colour blocks on the sheet again.

If you clean the print head and the print has not improved, try installing a new Brother Original replacement ink cartridge for each problem colour. Try cleaning the print head again. If the print has not improved, contact Brother customer service or your local Brother dealer.

## IMPORTANT

DO NOT touch the print head. Touching the print head may cause permanent damage and may void the print head's warranty.



When a print head nozzle is clogged, the printed sample looks like this:



After the print head nozzle is cleaned, the lines are gone:



## Related Information

- [Check Your Brother Machine](#)

### Related Topics:

- [Paper Handling and Printing Problems](#)
-

## Check the Print Alignment from Your Brother Machine

If your printed text becomes blurred or images become faded after transporting the machine, adjust the print alignment.

Before adjusting the print alignment, make a print quality check first by pressing  [Settings] > [Maintenance] > [Improve Print Quality] > [Check Print Quality].

1. Press  [Settings] > [Maintenance] > [Improve Print Quality] > [Alignment].
2. Press [Next].
3. Press [Yes] after a confirmation message if a print quality check has been completed appears on the LCD.
4. Press [Auto] or [Manual].
  - If you select the [Auto] mode, the print alignment is automatically adjusted by scanning the Alignment Check Sheet.
  - If you select the [Manual] mode, you need to input information printed on the Alignment Check Sheet manually.
5. If you selected the [Auto] mode, select the paper size to print the Alignment Check Sheet on.
6. Load specified size paper in the tray, and then press [Start].

The machine prints the Alignment Check Sheet.
7. Follow the instructions on the LCD.



When the print alignment is not adjusted correctly, text looks blurry or crooked, like this:

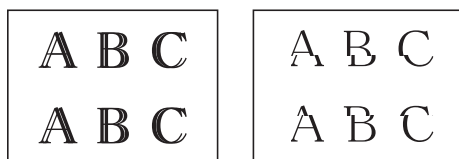

After the print alignment is adjusted correctly, text looks like this:



### Related Information

- [Check Your Brother Machine](#)

#### Related Topics:

- [Paper Handling and Printing Problems](#)

## Check the Ink Volume (Page Gauge)

Although an ink volume icon appears on the machine's LCD, you can view a larger graph that displays the ink left in each cartridge.

1. Press  [Settings] > [Maintenance] > [Ink Volume].

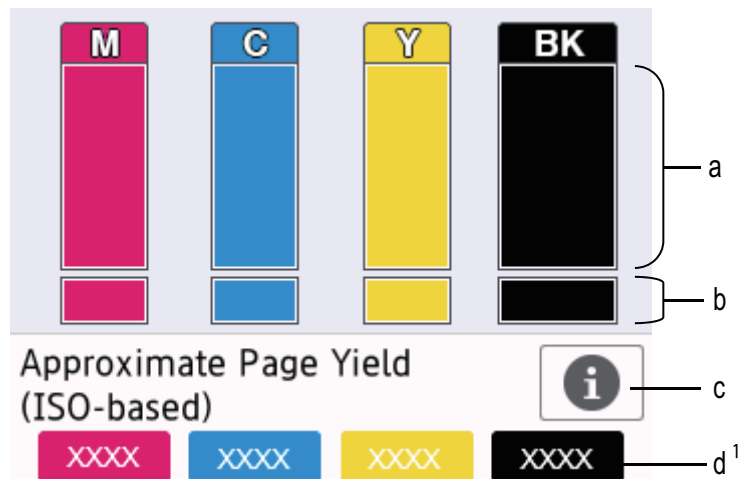

The touchscreen displays the ink volume and the page gauge <sup>1</sup>.



- a. Displays the cartridge ink level.
- b. Displays the ink level remaining in the internal ink reservoir.
- c. Press to change the display settings for the approximate page yield.
- d. The page gauge <sup>1</sup> shows the approximate number of remaining pages that can be printed with the cartridges.



- When the ink cartridge is near the end of its life or having a problem, one of the following icons appears:

	The ink level is low.
	The ink cartridge needs to be replaced.
	There is a problem with the ink cartridge.

- To check or print the ink cartridge model numbers, press  (Back) to return to the [Maintenance] menu screen.

Press [Ink Cartridge Model], and follow the instructions on the touchscreen.

2. Press .



- You can also check the ink volume from your computer.
- For detailed information about the measuring methods used for the approximate yields, visit [support.brother.com/yield](http://support.brother.com/yield).



### Related Information

- [Check Your Brother Machine](#)

#### Related Topics:

- [Touchscreen LCD Overview](#)

<sup>1</sup> Page Gauge is an estimate for informational purposes only and does not display the actual remaining page yield. For actual cartridge yield information, refer to [support.brother.com/yield](http://support.brother.com/yield).

- 
- [Settings Screen Overview](#)
  - [Print a Document \(Windows\)](#)
  - [Print a Document \(Mac\)](#)
  - [Monitor Machine Status from Your Computer \(Windows\)](#)
-

## Monitor Machine Status from Your Computer (Windows)

The Status Monitor utility is a configurable software tool for monitoring the status of one or more devices; it allows you to get immediate notification of errors.

- Do one of the following:

- Double-click the  icon in the task tray.
- Windows 7

Click  (Start) > All Programs > Brother > Brother Utilities.

Click the drop-down list and select your model name (if not already selected). Click **Tools** in the left navigation bar, and then click **Status Monitor**.

- Windows 8 and Windows 10

Click  (Brother Utilities), and then click the drop-down list and select your model name (if not already selected). Click **Tools** in the left navigation bar, and then click **Status Monitor**.

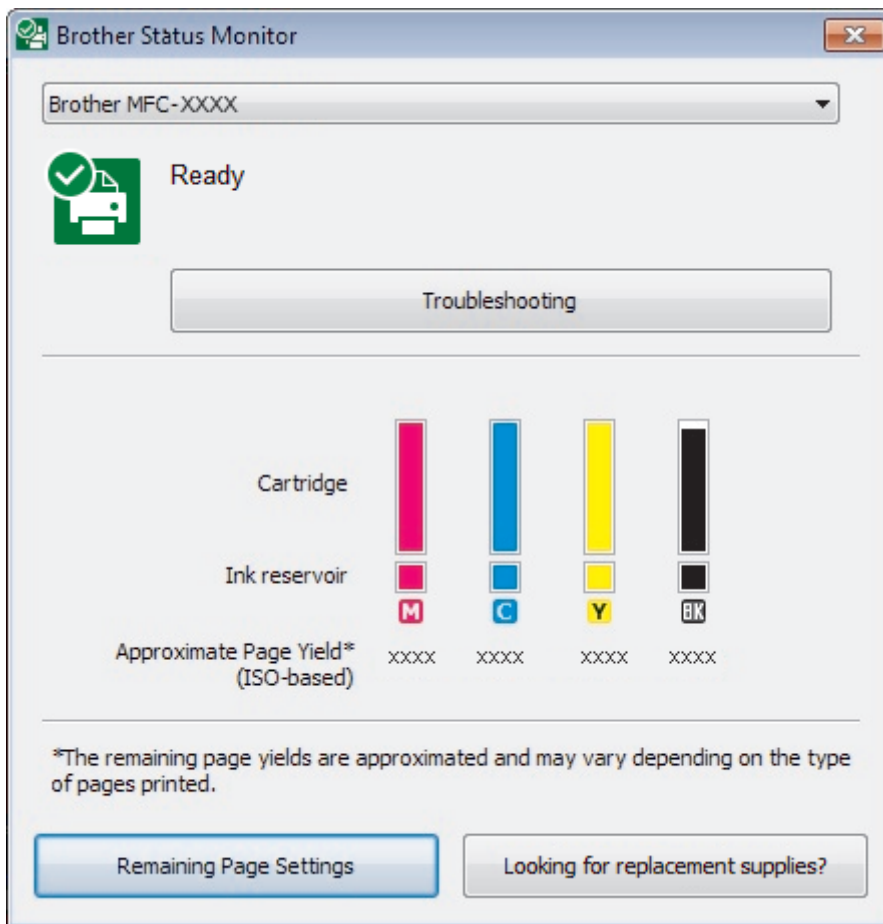

### Troubleshooting

Click the **Troubleshooting** button to access the troubleshooting website.

### Remaining Page Settings



Click the **Remaining Page Settings** button to change the display settings for the approximate page yield.

### Looking for replacement supplies?

Click the **Looking for replacement supplies?** button for more information on Brother original supplies.

---

## Error icons

Icon	Description
	The ink level is low.
	The ink cartridge needs to be replaced.
	There is a problem with the ink cartridge.



## Related Information

- [Check Your Brother Machine](#)
  - [Status Monitor Indicators and What They Mean \(Windows\)](#)
  - [Turn Off the Show Status Monitor Feature \(Windows\)](#)
  - [Turn Off the Status Monitor \(Windows\)](#)

### Related Topics:

- [Cancel a Print Job \(Windows\)](#)
  - [Check the Ink Volume \(Page Gauge\)](#)
-



## Status Monitor Indicators and What They Mean (Windows)

When you start up your computer, the **Brother Status Monitor** icon appears on the task tray.

- A green icon indicates the normal stand-by condition.



- A yellow icon indicates a warning.



- A red icon indicates an error has occurred.



- A grey icon indicates the machine is offline.



### Related Information

- [Monitor Machine Status from Your Computer \(Windows\)](#)

## Turn Off the Show Status Monitor Feature (Windows)

The Show Status Monitor feature lets you know if there is a problem with a device that your computer is monitoring. The default setting is **Only when printing from this PC**. To turn it off, follow these steps:

1. Right-click the  (**Brother Status Monitor**) icon or window, select the **Status Monitor Settings** option, and then click **Options**.

The **Options** window appears.

2. Select the **Basic** tab, and then select **Off** for **Show Status Monitor**.
3. Click **OK**.



Even if the Show Status Monitor feature is turned off, you can check the machine's status at any time by displaying the Status Monitor.



### Related Information

- [Monitor Machine Status from Your Computer \(Windows\)](#)

## Turn Off the Status Monitor (Windows)

1. Right-click the  (Brother Status Monitor) icon or window, and then select **Exit**.
2. Click **OK**.

### Related Information

- [Monitor Machine Status from Your Computer \(Windows\)](#)
-

## Monitor Machine Status from Your Computer (Mac)

Brother's Status Monitor utility program is a configurable software tool for monitoring the status of a device and notifying you immediately in the event of an error. You can also use Brother's Status Monitor to access Web Based Management.

1. Select **System Preferences** from the Apple menu.
2. Select **Printers & Scanners**, and then select the machine.
3. Click the **Options & Supplies** button.
4. Click the **Utility** tab, and then click the **Open Printer Utility** button.

The Status Monitor screen appears.

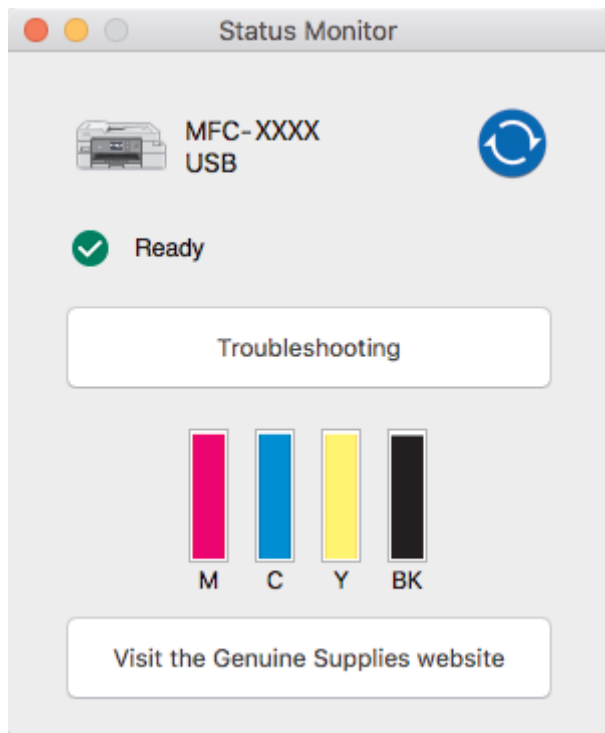

### Troubleshooting

Click the **Troubleshooting** button to access the Brother Solutions Center, offering **FAQs & Troubleshooting** tips.

### Visit the Genuine Supplies website

Click the **Visit the Genuine Supplies website** button for more information about Brother original supplies.



### Updating the machine's status

To view the latest machine status while the **Status Monitor** window is open, click the  icon. To set the interval at which the software updates the machine status information, click the **Brother Status Monitor** menu, and then select **Preferences**.

### Web Based Management (Network Connection Only)

Access the Web Based Management system by clicking the machine icon on the **Status Monitor** screen. You can use a standard web browser to manage your machine using Hyper Text Transfer Protocol (HTTP).

### Error icons

Icon	Description
	The ink level is low.
	The ink cartridge needs to be replaced.

---

Icon	Description
	There is a problem with the ink cartridge.



### Related Information

- [Check Your Brother Machine](#)

#### Related Topics:

- [Access Web Based Management](#)
-

## Correct the Paper Feed to Clear Vertical Lines

Adjust the paper feed to reduce vertical lines.

Before adjusting the paper feed, make a print quality check first by pressing  [Settings] > [Maintenance] > [Improve Print Quality] > [Check Print Quality].

1. Press  [Settings] > [Maintenance] > [Improve Print Quality] > [Correct Paper Feed].
2. Press [Next].
3. Press [Yes] after a confirmation message if a print quality check has been completed appears on the LCD.
4. Press [Auto] or [Manual].
  - If you select the [Auto] mode, the paper feed is automatically adjusted by scanning the adjustment sheet.
  - If you select the [Manual] mode, you need to input information printed on the adjustment sheet manually.
5. If you selected the [Auto] mode, select the paper size to print the adjustment sheet on.
6. Load specified size paper in the tray, and then press [Start].

The machine prints the adjustment sheet.
7. Follow the instructions on the LCD.



### Related Information

- [Routine Maintenance](#)

#### Related Topics:

- [Paper Handling and Printing Problems](#)
- [Other Problems](#)

## Change the Print Setting Options When Having Printing Problems

If your print result is poor quality, select these options depending on your purpose. When these settings are selected, the printing speed is slower.



These options are available only when performing operations from the machine, such as copying. When printing from your computer, change the settings in the printer driver.

1. Press  [Settings] > [Maintenance] > [Print Setting Options].
2. Press one of the following options:

Option	Description
Reduce Smudging	Select this option according to whether you are using 1-sided or 2-sided printing if you have problems with smudged printouts or paper jams.
Slow Drying Paper	Select this option if you use a type of plain paper on which ink dries slowly.

3. Follow the LCD menus.
4. Press .



### Related Information

- [Routine Maintenance](#)

#### Related Topics:

- [Copy on Both Sides of the Paper \(2-sided Copy\)](#)
- [Paper Handling and Printing Problems](#)
- [Other Problems](#)
- [Prevent Smudged Printouts and Paper Jams \(Windows\)](#)
- [Prevent Smudged Printouts and Paper Jams \(Mac\)](#)
- [Print Settings \(Windows\)](#)
- [Print Options \(Mac\)](#)

## Pack and Ship Your Brother Machine

- When you transport the machine, use the packing materials that came with your machine. Do not tip or turn the product upside down. If you do not pack the machine correctly, any damage that may occur in transit may not be covered by your warranty.
- The machine should be adequately insured with the carrier.

### IMPORTANT

It is important to allow the machine to “park” the print head after a print job. Listen carefully to the machine before unplugging it to make sure that all mechanical noises have stopped. Not allowing the machine to finish this parking process may lead to print problems and possible damage to the print head.

1. Unplug the machine from the electrical socket.
2. Unplug the machine from the telephone wall socket and take the telephone line cord out of the machine.
3. Using both hands, use the finger holds on each side of the machine to lift the scanner cover into the open position.
4. Unplug the interface cable from the machine, if it is connected.
5. Gently close the scanner cover using the finger holds on each side.

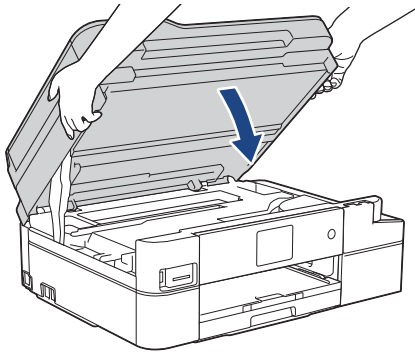

6. Open the ink cartridge cover.
7. Press the ink release levers to release the ink cartridges and then take out the ink cartridges.

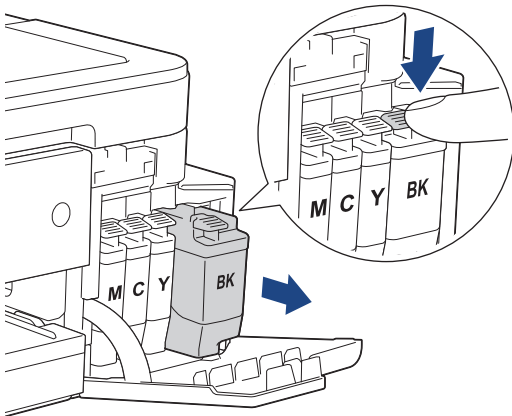

8. Wrap the machine in the bag.

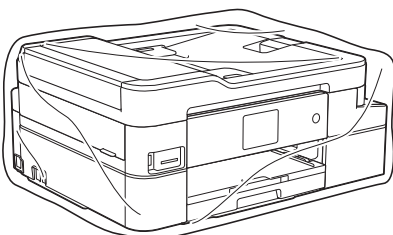



- 
9. Pack the machine in the original carton with the original packing material as shown below.  
Do not pack the used ink cartridge in the carton.

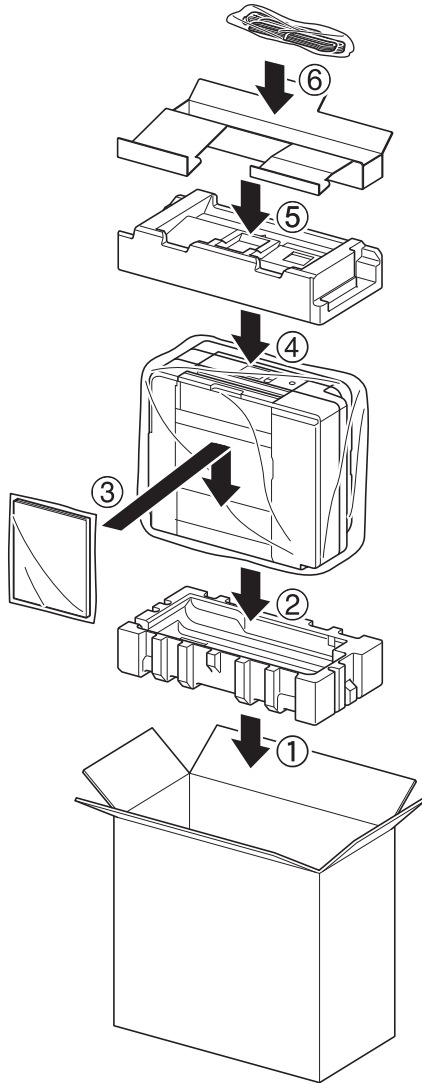

10. Close the carton and tape it shut.

### Related Information

- [Routine Maintenance](#)

#### **Related Topics:**

- [Replace the Ink Cartridges](#)
-

## Machine Settings

Customise settings and features, create shortcuts, and work with options displayed on the machine's LCD to make your Brother machine a more efficient work tool.

- [Change Machine Settings from the Control Panel](#)
- [Change Machine Settings from Your Computer](#)

## Change Machine Settings from the Control Panel

- [In the Event of Power Failure \(Memory Storage\)](#)
- [General Settings](#)
- [Save Your Favourite Settings as a Shortcut](#)
- [Print Reports](#)
- [Settings and Features Tables](#)

## In the Event of Power Failure (Memory Storage)

>> [DCP-J1100DW](#)

>> [MFC-J1300DW](#)

### DCP-J1100DW

- Your menu settings are stored permanently and will not be lost.
- Temporary settings (for example: Contrast and Overseas Mode) will be lost.
- The date and time must be re-entered.
- (MFC models) Programmed fax timer jobs and other fax jobs in the machine's memory will be lost.

### MFC-J1300DW

- Your menu settings are stored permanently and will not be lost.
- Temporary settings (for example: Contrast and Overseas Mode) will be lost.
- The date and time and programmed fax timer jobs (for example: Delayed Fax) will be retained for approximately 24 hours.
- Other fax jobs in the machine's memory will not be lost.



### Related Information

- [Change Machine Settings from the Control Panel](#)

## General Settings

- [Adjust the Machine Volume](#)
- [Change for Daylight Saving Time Automatically](#)
- [Set Sleep Mode Countdown](#)
- [Set the Machine to Power Off Automatically](#)
- [Set the Date and Time](#)
- [Set the Time Zone](#)
- [Adjust the LCD Backlight Brightness](#)
- [Change How Long the LCD Backlight Stays On](#)
- [Set Your Station ID](#)
- [Set Tone or Pulse Dialling Mode](#)
- [Prevent Dialling a Wrong Number \(Dial Restriction\)](#)
- [Reduce Printing Noise](#)
- [Change the Language Displayed on the LCD](#)
- [Change the Keyboard Setting](#)

## Adjust the Machine Volume

1. Do one of the following:

- For MFC models:

Press  [Settings] > [All Settings] > [General Setup] > [Volume].

- For DCP models:

Press  [Settings] > [All Settings] > [General Setup] > [Beep].

2. Press one of the following options (MFC models):

Option	Description
Ring	Adjust the ring volume.
Beep	Adjust the volume when you press a button, make a mistake, or after you send or receive a fax.
Speaker	Adjust the speaker volume.

3. Press ▲ or ▼ to display the [Off], [Low], [Med], or [High] option, and then press the option you want.

4. Press .



### Related Information



- [General Settings](#)

## Change for Daylight Saving Time Automatically

Related Models: MFC-J1300DW

You can program the machine to change automatically for Daylight Saving Time.

It will reset itself forward one hour in the spring, and backward one hour in the autumn. Make sure you have set the correct date and time in the [Date & Time] setting.

1. Press  [Settings].
2. Press  [Date & Time] > [Auto Daylight].
3. Press [On] or [Off].
4. Press .



### Related Information

- [General Settings](#)

## Set Sleep Mode Countdown

The Sleep Mode (or Power Save Mode) setting can reduce power consumption. When the machine is in Sleep Mode, it acts as though it is turned off. The machine will wake up and start printing when it receives a print job or a fax. Use these instructions to set a time delay (countdown) before the machine enters Sleep Mode.

- The timer will restart if any operation is carried out on the machine, such as receiving a fax or a print job.
- The factory setting is five minutes.
- When the machine goes into Sleep Mode, the LCD backlight turns off.

1. Press  [Settings] > [All Settings] > [General Setup] > [Sleep Mode].
2. Press ▲ or ▼ to display the [1Min], [2Mins], [3Mins], [5Mins], [10Mins], [30Mins], or [60Mins] option, and then press the option you want.
3. Press .



### Related Information

- [General Settings](#)

#### Related Topics:

- [Set the Machine to Power Off Automatically](#)



## Set the Machine to Power Off Automatically





The Auto Power Off feature can save power consumption. Set the amount of time that the machine will be in Sleep Mode before it automatically powers off. When this feature is set to [Off], you must power off the machine manually.

To turn on the machine after the Auto Power Off feature has turned it Off, press .



The machine will not power off automatically when:

- The machine is connected to a telephone line. (MFC-J1300DW)
- The machine is connected to a wired network. (MFC-J1300DW)
- The machine is connected to a wireless network.
- [WLAN Enable] is set to [On] or [WLAN] is selected in the [Network I/F] setting.

1. Press  [Settings] > [All Settings] > [General Setup] > [Auto Power Off].
2. Press  or  to display the [Off], [1hour], [2hours], [4hours], or [8hours] option, and then press the option you want.
3. Press .



### Related Information

- [General Settings](#)

#### Related Topics:

- [Set the Fax Journal's Interval Period](#)
- [Set Sleep Mode Countdown](#)



## Set the Date and Time

(MFC models)

The LCD displays the date and time. If they are not current, re-enter them. You can add the date and time to each fax you send by setting your Station ID.

(DCP models)

If the machine's power has been off, the machine's date and time may not be current. Re-enter them.

1. Press  [Settings].
2. Press  [Date & Time].
3. Press [Date].
4. Enter the last two digits of the year on the touchscreen, and then press [OK].
5. Enter two digits for the month on the touchscreen, and then press [OK].
6. Enter two digits for the day on the touchscreen, and then press [OK].
7. Press [Time].
8. Enter the time (in 24-hour format) using the touchscreen.  
Press [OK].  
(For example, enter 19:45 for 7:45 PM.)
9. Press .

### Related Information



- [General Settings](#)

#### Related Topics:

- [Register Your Machine with Google Cloud Print Using Web Based Management](#)
- [Set Your Station ID](#)

## Set the Time Zone

Set the time zone for your location on the machine.



1. Press  [Settings].
2. Press  [Date & Time] > [Time Zone].
3. Enter your time zone.
4. Press [OK].
5. Press .

### Related Information

- [General Settings](#)

## Adjust the LCD Backlight Brightness

If you are having difficulty reading the LCD, changing the brightness setting may help.

1. Press  [Settings] > [All Settings] > [General Setup] > [LCD Settings] > [Backlight].
2. Press the [Light], [Med], or [Dark] option.
3. Press .





### Related Information

- [General Settings](#)
-

## Change How Long the LCD Backlight Stays On

Set how long the LCD backlight stays on.

1. Press  [Settings] > [All Settings] > [General Setup] > [LCD Settings] > [Dim Timer].
2. Press ▲ or ▼ to display the [10Secs], [30Secs], [1Min], [2Mins], [3Mins], or [5Mins] option, and then press the option you want.
3. Press .



### Related Information

- [General Settings](#)



## Set Your Station ID

**Related Models:** MFC-J1300DW

Set the machine's Station ID if you want the date and time to appear on each fax you send.

1. Press  [Settings] > [All Settings] > [Initial Setup] > [Station ID].
2. Press [Fax].
3. Enter your fax number (up to 20 digits) on the touchscreen, and then press [OK].
4. Press [Name].
5. Enter your name (up to 20 characters) using the touchscreen, and then press [OK].



- Press  to cycle between letters, numbers and special symbols. (The available characters may differ depending on your country.)
- If you entered an incorrect character and want to change it, press ◀ or ▶ to move the cursor to it. Press  and then enter the correct character.
- To enter a space, press [Space].

6. Press .

### Related Information

- [General Settings](#)

#### **Related Topics:**



- [Transfer Faxes to Another Fax Machine](#)
- [Transfer the Fax Journal Report to Another Fax Machine](#)
- [Enter Text on Your Brother Machine](#)
- [Set the Date and Time](#)

## Set Tone or Pulse Dialling Mode

**Related Models:** MFC-J1300DW

Your Brother machine is set for a Tone dialling service. If you have a Pulse dialling (rotary) service, you must change the dialling mode.

This feature is not available in some countries.

1. Press  [Settings] > [All Settings] > [Initial Setup] > [Tone/Pulse].
2. Press [Tone] or [Pulse].
3. Press .

### Related Information

- [General Settings](#)

#### **Related Topics:**

- [Telephone and Fax Problems](#)

## Prevent Dialling a Wrong Number (Dial Restriction)

**Related Models:** MFC-J1300DW

This feature is to prevent users from sending a fax or call to a wrong number by mistake. You can set the machine to restrict Dialling when you use the dial pad, Address Book, Shortcuts and LDAP search.

1. Press  [Settings] > [All Settings] > [Fax] > [Dial Restriction].
2. Press one of the following options:
  - [Dial Pad]
  - [Address Book]



If you combine Address Book numbers when dialling, the address will be recognised as dial pad input and will not be restricted.

- [Shortcuts]
  - [LDAP Server]
3. Press one of the following options:

Option	Description
Enter # Twice	The machine will prompt you to re-enter the number. If you re-enter the same number correctly, the machine will start dialling. If you re-enter the wrong number, the touchscreen will show an error message.
On	The machine will restrict all fax sending and outbound calls for that dialling method.
Off	The machine does not restrict the dialling method.



- The [Enter # Twice] setting will not work if you use an external phone before entering the number. You will not be asked to re-enter the number.
- If you selected [On] or [Enter # Twice], you cannot use the Broadcasting feature.

4. Press .



### Related Information

- [General Settings](#)





## Reduce Printing Noise

The Quiet Mode setting can reduce printing noise. When Quiet Mode is turned on, the print speed becomes slower.

The factory setting is [Off].



- When the Quiet Mode setting is turned on,  appears on the Home screen.

1. Press  [Settings] > [Quiet Mode].
2. Press [On] or [Off].
3. Press .



### Related Information

- [General Settings](#)



#### Related Topics:

- [Touchscreen LCD Overview](#)
- [Paper Handling and Printing Problems](#)

## Change the Language Displayed on the LCD

Change the LCD language if needed.

This feature is not available in some countries.



1. Press  [Settings] > [All Settings] > [Initial Setup] > [Local Language].
2. Press your language.
3. Press .

### Related Information

- [General Settings](#)
-

## Change the Keyboard Setting

You can choose the type of keyboard for the LCD.

1. Press  [Settings] > [All Settings] > [General Setup] > [Keyboard Settings].
2. Press [QWERTY] or [ABC].
3. Press .



### Related Information

- [General Settings](#)
-

## Save Your Favourite Settings as a Shortcut

- [Add Shortcuts](#)
- [Change or Delete Shortcuts](#)
- [Assign a Shortcut to an IC Card](#)



## Add Shortcuts

You can add the Fax, Copy, Scan, Web Connect and Apps settings you use most frequently by saving them as your Shortcuts. Later you can press the Shortcut to apply these settings instead of manually re-entering them.



Some Shortcut menus are not available depending on your model.

These instructions describe how to add a Copy Shortcut. The steps for adding a Fax, Scan, Web Connect or Apps Shortcut are very similar.

1. Press  [Shortcuts].
2. Press ◀ or ▶ to display the Shortcut screens.
3. Press  where you have not added a Shortcut.
4. Press ▲ or ▼ to display [Copy].
5. Press [Copy].
6. Press [Options].
7. Press ▲ or ▼ to display the available settings, and then press the setting you want to change.
8. Press ▲ or ▼ to display the available options for the setting, and then press the option you want.  
Repeat the previous and this steps until you have selected all the settings for this Shortcut. When finished, press [OK].
9. Press [Save as Shortcut].
10. Read and confirm the displayed list of settings you have selected, and then press [OK].
11. Enter a name for the Shortcut using the LCD, and then press [OK].



When adding Fax or Scan to Shortcuts, you will be asked if you want to make this a One Touch Shortcut. Follow the LCD instructions.



### Related Information

- [Save Your Favourite Settings as a Shortcut](#)

## Change or Delete Shortcuts

You can change the settings in a Shortcut.

You cannot change a Web Connect Shortcut or Apps Shortcut. If you need to change them, delete them, and then add a new Shortcut.

1. Press  [Shortcuts].
2. Press ◀ or ▶ to display the Shortcut you want to change.
3. Press and hold the Shortcut you want to change.
4. Press [Edit].



To delete the Shortcut, press [Delete]. To edit the name of the Shortcut, press [Rename] and follow the LCD menus.

5. Change the settings for the Shortcut you selected.
6. Press [Save as Shortcut] when you have finished changing the settings.
7. Press [OK] to confirm.



When changing Fax or Scan Shortcuts, you will be asked if you want to make this a One Touch Shortcut. Follow the LCD instructions.



### Related Information

- [Save Your Favourite Settings as a Shortcut](#)

#### Related Topics:

- [Enter Text on Your Brother Machine](#)

## Assign a Shortcut to an IC Card

- Assign a Shortcut to an IC Card with IC Card Reader

## Assign a Shortcut to an IC Card with IC Card Reader

You can assign one machine Shortcut to your IC card. When you touch your IC card to the IC card reader connected to your machine, your personal Shortcut will automatically appear on the touchscreen.



- You cannot use the same IC card for different Shortcuts.
- To use the IC card for another Shortcut, unregister the card first, and then register it with the new Shortcut.

Before assign a shortcut to an IC card, register an external IC card reader. Use Web Based Management to register the card reader. Your machine supports HID class driver supported external IC card reader.

1. Start your web browser.  
Type "https://machine's IP address" in your browser's address bar (where "machine's IP address" is the IP address of the machine or the print server name). For example: https://192.168.1.2  
If the machine prompts you for a password, type it, and then click .
2. Click the **Administrator** tab.
3. Click the **External Card Reader** menu, and then enter the necessary information.
4. Click **Submit**.
5. Restart your Brother machine to activate the configuration.
6. Unplug the power cord from the electrical socket.
7. Connect the card reader to your machine, and then plug the machine's power cord into the electrical socket.

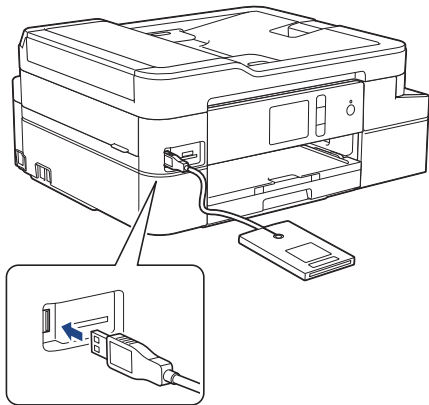

8. Press  [Shortcuts] on the LCD.
9. Press ◀ or ▶ to select the Shortcut screens that contains the Shortcut you want to assign to your IC card.
10. Press and hold the Shortcut until the options appear.
11. Press [Register Card/NFC].
12. Touch the IC card to the IC card reader connected to your machine.
13. Press [Register].

The Shortcut is assigned to the IC Card.



### Related Information

- [Assign a Shortcut to an IC Card](#)



## Print Reports

- [Reports](#)
- [Print a Report](#)
- [Fax Reports](#)
- [Telephone and Fax Problems](#)

## Reports

The following reports are available:

### Transmission Verify (MFC models)

The Transmission Verify prints a Transmission Verification Report for your last transmission.

### Address Book (MFC models)

The Address Book report prints a list of names and numbers stored in the Address Book memory.

### Fax Journal (MFC models)

The Fax Journal prints a list of information about your last 200 incoming and outgoing faxes. (TX means Transmit, RX means Receive.)



(Windows)

You can view and print the Fax Journal report from your computer using the **Fax Journal Report** software. Go to your model's **Downloads** page on the Brother Solutions Center at [support.brother.com](http://support.brother.com) to download the software.

### User Settings

The User Settings report prints a list of your current settings.

### Network Configuration (network models)

The Network Configuration report prints a list of your current network settings.

### WLAN Report (wireless models)

The WLAN Report prints the wireless LAN connectivity diagnosis.

### Caller ID history (MFC models)



The Caller ID History report prints a list of the available Caller ID information for the last 30 received faxes and telephone calls.



### Related Information

- [Print Reports](#)

## Print a Report

1. Press  [Settings] > [All Settings] > [Print Reports].
2. Press ▲ or ▼ to display the report options, and then press the option you want.
3. Press [Yes].
4. Press .

### Related Information

- [Print Reports](#)

#### Related Topics:

- [Caller ID](#)

## Settings and Features Tables

- [Settings Tables \(2.7"\(67.5 mm\) Touchscreen models\)](#)
- [Features Tables \(2.7"\(67.5 mm\) Touchscreen models\)](#)

## Settings Tables (2.7"(67.5 mm) Touchscreen models)

These tables will help you understand your machine's menu selections and options.

- >> [Settings]
- >> [General Setup]
- >> [Shortcut Settings]
- >> [Fax]
- >> [Network]
- >> [Print Reports]
- >> [Machine Info.]
- >> [Initial Setup]

### [Settings]



### [Settings]

Level 1	Level 2	Level 3	Descriptions
 (Date & Time)	Date	-	(MFC models)
	Time	-	Add the date and time on the screen and in the headings of the faxes you send. (DCP models) Set the date and time on your machine.
	Auto Daylight (MFC models)	-	Set the machine to change automatically for Daylight Saving Time.
	Time Zone	-	Set your time zone.
Maintenance	Improve Print Quality	-	Check and correct the print quality, alignment and paper feeding according to the LCD instructions.
	Print Head Cleaning	-	Clean the print head according to the LCD instructions.
	Ink Volume	-	Check the available ink volume.
	Ink Cartridge Model	-	Check your ink cartridge numbers.
	Print Setting Options	Reduce Smudging	
Slow Drying Paper			Use this setting when printing with a type of plain paper on which the ink dries very slowly.
Wi-Fi	TCP/IP	-	Set TCP/IP protocol.
	Setup Wizard	-	Configure your wireless network settings manually.
	WLAN Assistant	-	Configure your wireless network settings using the Brother installation disc.
	WPS	-	Configure your wireless network settings using the one-button push method.
	WPS w/ PIN Code	-	Configure your wireless network settings using WPS with a PIN.
	WLAN Status	-	View the current wireless network status.
	MAC Address	-	View the machine's MAC address.
Quiet Mode	-	-	Decrease printing noise.
Tray Setting (MFC-J1300DW)	Paper Type	-	Set the type of paper in the paper tray.
	Paper Size	-	Set the size of paper in the paper tray.

Level 1	Level 2	Level 3	Descriptions
Tray Setting (MFC-J1300DW)	(MFC-J1300DW)		
Paper Type (DCP-J1100DW)	-	-	Set the type of paper in paper tray #1.
Paper Size (DCP-J1100DW)	-	-	Set the size of paper in paper tray #1.
Fax Preview (MFC-J1300DW)	-	-	View received faxes on the LCD.
All Settings	-	-	Configure the detailed settings.

## [General Setup]



[Settings] > [All Settings] > [General Setup]

Level 1	Level 2	Level 3	Descriptions
Maintenance	Improve Print Quality	-	Check and correct the print quality, alignment and paper feeding according to the LCD instructions.
	Print Head Cleaning	-	Clean the print head according to the LCD instructions.
	Ink Volume	-	Check the available ink volume.
	Ink Cartridge Model	-	Check your ink cartridge numbers.
	Print Setting Options	Reduce Smudging	
Slow Drying Paper			Use this setting when printing with a type of plain paper on which the ink dries very slowly.
Paper Type	-	-	Set the type of paper in the paper tray.
Paper Size	-	-	Set the size of paper in the paper tray.
Check Paper	-	-	Check the paper type and paper size when you pull the tray out of the machine.
Quiet Mode	-	-	Decrease printing noise.
Beep (DCP models)	-	-	Adjust the beeper volume.
Volume (MFC models)	Ring	-	Adjust the ring volume.
	Beep	-	Adjust the beeper volume.
	Speaker	-	Adjust the speaker volume.
LCD Settings	Backlight	-	Adjust the brightness of the LCD backlight.
	Dim Timer	-	Set how long the LCD backlight stays on after the last finger press.
Screen Settings	Scan Screen	-	Set the default Scan screen settings.
Notice Settings	Scan Result (Skip Blank Page)	-	Displays a scan result of skip blank page when finished.
Keyboard Settings	-	-	Select the type of keyboard for the LCD.
Sleep Mode	-	-	Select how long the machine must be idle before it goes into Sleep Mode.

Level 1	Level 2	Level 3	Descriptions
Auto Power Off	-	-	Select how long the machine must wait before it automatically turns itself off after entering Sleep Mode. When set to Off, the machine will not power off automatically.
Removable Disc	-	-	Turn the Removable Disc function on or off.

### [Shortcut Settings]

 [Settings] > [All Settings] > [Shortcut Settings]

Level 1	Level 2	Descriptions
(Select shortcut button.)	Rename	Change the shortcut name.
	Edit	Change the shortcut settings.
	Delete	Delete the shortcut.
	Register Card/NFC	Assign a Shortcut to an IC card.
	Delete Card/NFC	Remove a Shortcut from an IC card.

### [Fax]

 [Settings] > [All Settings] > [Fax] (MFC models)

Level 1	Level 2	Level 3	Descriptions
Setup Receive	Ring Delay	-	Set the number of rings before the machine answers in Fax Only or Fax/Tel mode.
	Receive Mode	-	Select the Receive Mode that best suits your needs.
	F/T Ring Time	-	Set the length of the pseudo/double-ring time in Fax/Tel mode.
	Fax Preview (MFC-J1300DW)	-	View received faxes on the LCD.
	Fax Detect	-	Receive fax messages automatically when you answer a call and hear fax tones.
	Remote Codes	-	Answer calls at an extension or external telephone and use codes to turn the Remote Codes on or off. You can personalise the codes.
	Auto Reduction	-	Reduce the size of incoming faxes.
	PC Fax Receive	-	Set the machine to send faxes to your computer. You can turn on the Backup Print safety feature.
	Memory Receive	-	Set the machine to forward fax messages, to store incoming faxes in the memory (so you can retrieve them while you are away from your machine), or the cloud service. If you select Fax Forward, or Forward to Cloud, you can turn on the Backup Print safety feature.
Report Setting	Fax Rx Stamp	-	Print the received time and date on the top of received faxes.
	XMIT Report	-	Select the initial setup for the Transmission Verification Report.
	Journal Period	-	Set the interval for automatic printing of the Fax Journal. If you select an option other than Off and Every 50 Faxes, you can set the time for the option.

Level 1	Level 2	Level 3	Descriptions
Report Setting			If you select Every 7 Days, you can set the day of the week.
Print Document	-	-	Print received faxes stored in the machine's memory.
Remote Access	-	-	Set your own code for Remote Retrieval.
Dial Restriction (MFC-J1300DW)	Dial Pad	-	Set the machine to restrict dialling when using the dial pad.
	Address Book (MFC-J1300DW)	-	Set the machine to restrict the dialling when using the Address Book.
	Shortcuts (MFC-J1300DW)	-	Set the machine to restrict the dialling when using a Shortcut.
	LDAP Server (MFC-J1300DW)	-	Set the machine to restrict dialling when using LDAP search.
Remaining Jobs	-	-	Check which scheduled jobs are in the machine's memory and cancel selected jobs.
Miscellaneous	BT Call Sign (U.K. only)	-	Use with BT Call Sign.
	Caller ID (U.K. and Ireland only)	-	View or print a list of the last 30 Caller IDs stored in the memory.

## [Network]



[Settings] > [All Settings] > [Network]

Level 1	Level 2	Level 3	Level 4	Descriptions
Wired LAN (MFC-J1300DW)	TCP/IP	BOOT Method	-	Select the Boot method that best suits your needs.
		IP Address	-	Enter the IP address.
		Subnet Mask	-	Enter the Subnet mask.
		Gateway	-	Enter the Gateway address.
		Node Name	-	Enter the Node name.
		WINS Configuration	-	Select the WINS configuration mode.
		WINS Server	-	Specify the IP address of the primary or secondary WINS server.
		DNS Server	-	Specify the IP address of the primary or secondary DNS server.
		APIPA	-	Set the machine to allocate the IP address from the link-local address range automatically.
	IPv6	-	Turn the IPv6 protocol on or off. For more information, go to the Brother Solutions Center at <a href="http://support.brother.com">support.brother.com</a> to see <b>FAQs &amp; Troubleshooting</b> .	
Ethernet	-	-	Select the Ethernet link mode.	
Wired Status	-	-	View the current wired status.	
MAC Address	-	-	View the machine's MAC address.	
WLAN	TCP/IP	BOOT Method	-	Select the Boot method that best suits your needs.
		IP Address	-	Enter the IP address.
		Subnet Mask	-	Enter the Subnet mask.



Level 1	Level 2	Level 3	Level 4	Descriptions
WLAN	TCP/IP	Gateway	-	Enter the Gateway address.
		Node Name	-	Enter the Node name.
		WINS Configuration	-	Select the WINS configuration mode.
		WINS Server	-	Specify the IP address of the primary or secondary WINS server.
		DNS Server	-	Specify the IP address of the primary or secondary DNS server.
		APIPA	-	Set the machine to allocate the IP address from the link-local address range automatically.
		IPv6	-	Turn the IPv6 protocol on or off. For more information, go to the Brother Solutions Center at <a href="http://support.brother.com">support.brother.com</a> to see <b>FAQs &amp; Troubleshooting</b> .
	Setup Wizard	-	-	Configure your wireless network settings manually.
	WLAN Assistant	-	-	Configure your wireless network settings using the Brother installation disc.
	WPS	-	-	Configure your wireless network settings using the one-button push method.
	WPS w/ PIN Code	-	-	Configure your wireless network settings using WPS with a PIN.
	WLAN Status	Status	-	View the current wireless network status.
		Signal	-	View the current wireless network signal strength.
		SSID	-	View the current SSID.
		Comm. Mode	-	View the current Communication mode.
	MAC Address	-	-	View the machine's MAC address.
Wi-Fi Direct	Push Button	-	-	Configure your Wi-Fi Direct network settings using the one-button push method.
	PIN Code	-	-	Configure your Wi-Fi Direct network settings using WPS with a PIN code.
	Manual	-	-	Configure your Wi-Fi Direct network settings manually.
	Group Owner	-	-	Set your machine as the Group Owner.
	Device Information	Device Name	-	View your machine's device name.
		SSID	-	View the Group Owner's SSID. When the machine is not connected, the LCD displays Not Connected.
		IP Address	-	View your machine's current IP Address.
	Status Information	Status	-	View the current Wi-Fi Direct network status.
		Signal	-	View the current Wi-Fi Direct network signal strength. When your machine acts as Group Owner, the LCD always indicates a strong signal.

Level 1	Level 2	Level 3	Level 4	Descriptions
Wi-Fi Direct	I/F Enable	-	-	Turn the Wi-Fi Direct connection on or off.
NFC (MFC-J1300DW)	-	-	-	Turn the NFC function on or off.
Message from Brother	Message from Brother	-	-	Display messages and notifications from Brother.
	Status	-	-	
Web Connect Settings	Proxy Settings	Proxy Connection	-	Change the Web connection settings.
		Address	-	
		Port	-	
		User Name	-	
		Password	-	
Network I/F (MFC-J1300DW)	-	-	-	Select the network connection type.
WLAN Enable (DCP-J1100DW)	-	-	-	Turn wireless network connection On or Off.
IPsec	-	-	-	IPsec is an optional security feature of the IP protocol that provides authentication and encryption services. We recommend contacting your network administrator before changing this setting.
Network Reset	-	-	-	Restore all network settings back to the factory settings.

## [Print Reports]



[Settings] > [All Settings] > [Print Reports]

Level 1	Descriptions
XMIT Verify (MFC models)	Print a Transmission Verification Report for your last transmission.
Address Book (MFC models)	Print a list of names and numbers stored in the Address Book.
Fax Journal (MFC models)	Print a list of information about your last 200 incoming and outgoing faxes. (TX means Transmit. RX means Receive.)
User Settings	Print a list of your settings.
Network Configuration	Print a list of your Network settings.
WLAN Report	Print the wireless LAN connection results.
Caller ID History (MFC models)	Print a list of the available Caller ID information about the last 30 received faxes and telephone calls.

## [Machine Info.]



[Settings] > [All Settings] > [Machine Info.]

Level 1	Level 2	Descriptions
Serial No.	-	Check your machine's serial number.
Firmware Version	Main Version	Check your machine's firmware version.
Firmware Update	-	Update your machine to the latest firmware.
Firmware Auto Check	-	View firmware information on the Home screen.

## [Initial Setup]



[Settings] > [All Settings] > [Initial Setup]

Level 1	Level 2	Descriptions
Date & Time	Date	(MFC models)
	Time	Add the date and time on the screen and in the headings of the faxes you send. (DCP models) Set the date and time on your machine.
	Auto Daylight (MFC models)	Set the machine to change automatically for Daylight Saving Time.
	Time Zone	Set your time zone.
Station ID (MFC models)	Fax	Enter your name and fax number so it appears on each page you fax.
	Name	
Tone/Pulse (MFC models) (Available only for some countries.)	-	Select the dialling mode.
Fax Auto Redial (MFC models)	-	Set the machine to redial the last fax number if the fax did not go through because the line was busy.
Dial Tone (MFC models)	-	Shorten the dial tone detect pause.
Phone Line Set (MFC models)	-	Select the telephone line type.
Compatibility (MFC models)	-	Adjust the equalisation for transmission difficulties. VoIP service providers offer fax support using various standards. If you regularly experience fax transmission errors, select Basic (for VoIP).
Reset	Machine Reset	Restore all the machine's settings that you have changed, such as Date and Time and Ring Delay.
	Network	Restore all network settings back to the factory settings.
	Address Book & Fax (MFC models)	Erase all stored phone numbers and fax settings.
	All Settings	Restore all the machine's settings back to the factory settings.
Local Language (Available only for some countries.)	-	Change your LCD language.



---

## Related Information

- [Settings and Features Tables](#)
-

## Features Tables (2.7"(67.5 mm) Touchscreen models)

- >>  [Fax]
- >>  [Copy]
- >>  [Scan]
- >>  [Photo]
- >>  [Web]
- >>  [Apps]
- >>  [Download Software]
- >>  [Shortcuts]
- >>  [Ink]
- >>  Wi-Fi Setup
- >> When you have put a USB Flash drive in the USB slot

### [Fax]

#### (When [Fax Preview] is [Off]) (MFC models)

Level 1	Level 2	Level 3	Descriptions
Pause	-	-	When you are entering a fax or telephone number on the control panel, Pause appears on the LCD. Press Pause when you need a delay while dialling numbers, such as access codes and credit card numbers. You can also store a pause when you set up addresses.
Address Book	 (Search:)	-	When LDAP is off, the search will be within the Local Address Book. When LDAP is on, the search will be within the Local Address Book and LDAP Server.
		Detail (This will appear only when LDAP is on.)	View detailed information about the selected address.
	Edit	-	Store Address Book numbers, set up Group numbers for Broadcasting, and change and delete Address Book numbers.
	-	Apply	Start sending a fax using the Address Book.
Call History	Redial	-	Redial the last number you dialled.
	Outgoing Call	Apply	Select a number from the Outgoing Call history and then send a fax to it, add it to the Address Book, or delete it.
		Edit	
	Caller ID History	Apply	Select a number from the Caller ID History and then send a fax to it, add it to the Address Book, or delete it.
Edit			
Options	Fax Resolution	-	Set the resolution for outgoing faxes.
	Contrast	-	Adjust the contrast.

Level 1	Level 2	Level 3	Descriptions
Options	Glass Scan Size	-	Adjust the scan area of the scanner glass to the size of the document.
	Broadcasting	Add Number	Send the same fax message to more than one fax number.
	Preview (MFC-J1300DW)	-	Preview a fax message before you send it.
	Colour Setting	-	Set whether faxes are sent in monochrome or colour.
	Delayed Fax	Delayed Fax	Set the time of day the delayed faxes will be sent.
		Set Time	
	Batch TX	-	Combine delayed faxes to the same fax number at the same time of day into one transmission.
	Real Time TX	-	Send a fax without using the memory.
	Overseas Mode	-	Set to On if you have difficulty sending faxes overseas.
	Call History	Redial	Redial the last number you dialed.
		Outgoing Call	Select a number from the Outgoing Call history and then send a fax to it, add it to the Address Book, or delete it.
		Caller ID History	Select a number from the Caller ID History and then send a fax to it, add it to the Address Book, or delete it.
	Address Book	 (Search:)	When LDAP is off, the search will be within the Local Address Book. When LDAP is on, the search will be within the Local Address Book and LDAP Server.
		Edit	Store Address Book numbers, set up Group numbers for Broadcasting, and change and delete Address Book numbers.
Set New Default		-	Save your settings as the default.
Factory Reset	-	Restore all settings back to the factory settings.	
Save as Shortcut	-	-	Save the current settings as a shortcut.

**(When [Fax Preview] is [On])**

Level 1	Level 2	Level 3	Level 4	Descriptions
Sending Faxes	Pause	-	-	When you are entering a fax or telephone number on the control panel, Pause appears on the LCD. Press Pause when you need a delay while dialling numbers, such as access codes and credit card numbers. You can also store a pause when you set up addresses.
	Address Book	 (Search:)	-	When LDAP is off, the search will be within the Local Address Book. When LDAP is on, the search will be within the Local Address Book and LDAP Server.
			Detail (This will appear only when LDAP is on.)	View detailed information about the selected address.
		Edit	-	Store Address Book numbers, set up Group numbers for Broadcasting, and change and delete Address Book numbers.
		-	Apply	Start sending a fax using the Address Book.

Level 1	Level 2	Level 3	Level 4	Descriptions
Sending Faxes	Call History	Redial	-	Redial the last number you dialled.
		Outgoing Call	Apply	Select a number from the Outgoing Call history and then send a fax to it, add it to the Address Book, or delete it.
			Edit	
		Caller ID History	Apply	Select a number from the Caller ID History and then send a fax to it, add it to the Address Book, or delete it.
			Edit	
		Options	Fax Resolution	-
	Contrast		-	Adjust the contrast.
	Glass Scan Size		-	Adjust the scan area of the scanner glass to the size of the document.
	Broadcasting		Add Number	Send the same fax message to more than one fax number.
	Preview		-	Preview a fax message before you send it.
	Colour Setting		-	Set whether faxes are sent in monochrome or colour.
	Delayed Fax		Delayed Fax	Set the time of day the delayed faxes will be sent.
			Set Time	
	Batch TX		-	Combine delayed faxes to the same fax number at the same time of day into one transmission.
	Real Time TX		-	Send a fax without using the memory.
	Overseas Mode		-	Set to On if you have difficulty sending faxes overseas.
	Call History		Redial	Redial the last number you dialled.
			Outgoing Call	Select a number from the Outgoing Call history and then send a fax to it, add it to the Address Book, or delete it.
			Caller ID History	Select a number from the Caller ID History and then send a fax to it, add it to the Address Book, or delete it.
	Address Book	 (Search:)	When LDAP is off, the search will be within the Local Address Book.	
When LDAP is on, the search will be within the Local Address Book and LDAP Server.				
Edit		Store Address Book numbers, set up Group numbers for Broadcasting, and change and delete Address Book numbers.		
Set New Default		-	Save your settings as the default.	
Factory Reset	-	Restore all settings back to the factory settings.		
Save as Shortcut	-	-	Save the current settings as a shortcut.	
Received Faxes	Print/Delete	Print All (New Faxes)	-	Print the new received faxes.
		Print All (Old Faxes)	-	Print the old received faxes.
		Delete All (New Faxes)	-	Delete the new received faxes.

Level 1	Level 2	Level 3	Level 4	Descriptions
Received Faxes	Print/Delete	Delete All (Old Faxes)	-	Delete the old received faxes.
Address Book	 (Search:)	-	-	When LDAP is off, the search will be within the Local Address Book. When LDAP is on, the search will be within the Local Address Book and LDAP Server.
		Detail (This will appear only when LDAP is on.)	-	View detailed information about the selected address.
	Edit	-	-	Store Address Book numbers, set up Group numbers for Broadcasting, and change and delete Address Book numbers.
	-	Apply	-	Start sending a fax using the Address Book.
Call History	Redial	-	-	Redial the last number you dialled.
	Outgoing Call	Apply	-	Select a number from the Outgoing Call history and then send a fax to it, add it to the Address Book, or delete it.
		Edit	-	
	Caller ID History	Apply	-	Select a number from the Caller ID History and then send a fax to it, add it to the Address Book, or delete it.
Edit		-		



[Copy]

Level 1	Level 2	Level 3	Descriptions	
Save as Shortcut	-	-	Save the current settings as a shortcut.	
Options	Quality	-	Select the Copy resolution for your document type.	
	Paper Type	-	Select the paper type that matches the paper in the tray.	
	Paper Size	-	Select the paper size that matches the paper in the tray.	
	Enlarge/Reduce	100%	-	
		Enlarge	-	Select an enlargement ratio for the next copy.
		Reduce	-	Select a reduction ratio for the next copy.
		Fit to Page	-	Adjust the copy size to fit on the paper size you have set.
		Custom (25-400%)	-	Enter an enlargement or reduction ratio.
	2-sided Copy	-	Turn off or turn on 2-sided copying and select flip on long edge or flip on short edge.	
	Density	-	Adjust the density.	
	Remove Background Colour	Black Copy Settings	-	Change the amount of background colour that is removed.
Colour Copy Settings		-		
Stack/Sort	-	-	Select to stack or sort multiple copies.	
Page Layout	-	-	Make N in 1, 2 in 1 ID, or Poster copies.	
Advanced Settings	-	-	Select advanced copy settings.	



Level 1	Level 2	Level 3	Descriptions
Options	Set New Default	-	Save your settings as the default.
	Factory Reset	-	Restore all settings back to the factory settings.



## [Scan]

Level 1	Level 2	Level 3	Level 4	Descriptions
to Media (When a memory card or USB Flash drive is inserted)	Other Scan to Actions	-	-	Scan documents and save them directly to a memory card or USB flash drive without using a computer.
	Options	-	-	
	Save as Shortcut	-	-	
to My Folder	-	-	-	Send scanned data to your folder in the CIFS server on your local network or on the Internet.
to PC	to File	Other Scan to Actions	-	Scan documents and save them to a folder on your computer.
		(Select USB or PC)	Options	
			Save as Shortcut	
	to OCR	Other Scan to Actions	-	Convert your scanned document to an editable text file.
		(Select USB or PC)	Options	
			Save as Shortcut	
	to Image	Other Scan to Actions	-	Scan photos or graphics into your graphics applications.
		(Select USB or PC)	Options	
			Save as Shortcut	
	to E-mail	Other Scan to Actions	-	Send a scanned document as an email attachment.
		(Select USB or PC)	Options	
			Save as Shortcut	
to FTP/SFTP	Other Scan to Actions	-	-	Scan documents directly to an FTP/SFTP server.
	(Select Profile name)	Options	-	
		Save as Shortcut	-	
to Network	Other Scan to Actions	-	-	Scan documents directly to a CIFS server on your local network.
	(Select Profile name)	Options	-	
		Save as Shortcut	-	
to SharePoint	Other Scan to Actions	-	-	Scan documents directly to a SharePoint server.
	(Select Profile name)	Options	-	

Level 1	Level 2	Level 3	Level 4	Descriptions
to SharePoint	(Select Profile name)	Save as Shortcut	-	Scan documents directly to a SharePoint server.
to Web	-	-	-	Upload the scanned data to an Internet service.
WS Scan (Appears when you install a Web Services Scanner, which is displayed in your computer's Network explorer.)	Other Scan to Actions	-	-	Scan data using the Web Service protocol.
	Scan	-	-	
	Scan for E-mail	-	-	
	Scan for Fax	-	-	
	Scan for Print	-	-	



## [Photo]

Level 1	Level 2	Level 3	Level 4	Descriptions
Select Files	OK	Print Settings	-	Adjust your photos with the options.
	Print All	Print Settings	-	Print all photos in your media.
Index Print	Print Index Sheet	Print Settings	-	Print a thumbnail page.
	Print Photos	Print Settings	-	Print photos by choosing the index numbers.
ID Photo Print	Select ID Photo Size	Rotate Image	Print Settings	Print ID photos for your resume, passport and so on.



## [Web]

Level 1	Descriptions
Web	Connect the Brother machine to an Internet service.



## [Apps]

Level 1	Descriptions
Apps	Connect the Brother machine to the Brother Apps service.



## [Download Software]

Level 1	Descriptions
Download Software	Displays information about downloading and installing software for mobile devices and computers.



## [Shortcuts]

Level 1	Level 2	Level 3	Descriptions
Add Shortcut	Copy	-	Change the settings in the Copy Options.
	Fax (MFC models)	-	Change the settings in the Fax Options.

Level 1	Level 2	Level 3	Descriptions
Add Shortcut	Scan	to PC (File)	Scan documents and save them to a folder on your computer.
		to PC (OCR)	Convert your scanned document to an editable text file.
		to PC (Image)	Scan photos or graphics into your graphics applications.
		to PC (E-mail)	Send a scanned document as an email attachment.
		to Media	Scan documents and save them directly to a memory card or USB flash drive without using a computer.
		to Network	Send scanned data to a CIFS server on your local network or on the Internet.
		to FTP/SFTP	Send scanned data via FTP/SFTP.
		to SharePoint	Send scanned data to a SharePoint server.
	Web	-	Connect the Brother machine to an Internet service.
Apps	-	Connect the Brother machine to the Brother Apps service.	
This list appears when each Shortcut icon is pressed for 2 seconds.	Rename	-	Change the shortcut name.
	Edit	-	Change the shortcut settings.
	Delete	-	Delete the shortcut.
	Register Card/NFC	-	Assign a Shortcut to an IC card.
	Delete Card/NFC	-	Remove a Shortcut from an IC card.
Edit/Delete	(Select shortcut button.)	Rename	Change the shortcut name.
		Edit	Change the shortcut settings.
		Delete	Delete the shortcut.
		Register Card/NFC	Assign a Shortcut to an IC card.
		Register Card/NFC	Remove a Shortcut from an IC card.



Level 1	Level 2	Descriptions
Ink Volume	-	Check the available ink volume.
Ink Cartridge Model	-	Check your ink cartridge numbers.
Improve Print Quality	-	Check and correct the print quality, alignment and paper feeding according to the LCD instructions.
Print Head Cleaning	-	Clean the print head according to the LCD instructions.
Print Setting Options	Reduce Smudging	Reduce smudging on the paper or paper jams during printing.
	Slow Drying Paper	Use this setting when printing with a type of plain paper on which the ink dries very slowly.

## WiFi Wi-Fi Setup

Level 1	Descriptions
Setup Wizard	Configure your wireless network settings manually.
WLAN Assistant	Configure your wireless network settings using the Brother installation disc.
WPS	Configure your wireless network settings using the one-button push method.

## When you have put a USB Flash drive in the USB slot

Level 1	Descriptions
Photo	Select photo menu.
Scan to Media	Scan documents into your media
Web	Connect the Brother machine to an Internet service.



### Related Information

- [Settings and Features Tables](#)

## **Change Machine Settings from Your Computer**

- [Change Machine Settings Using Web Based Management](#)
- [Change the Machine Settings Using Remote Setup](#)
- [Where Can I Find My Brother Machine's Network Settings?](#)
- [Network Management Software and Utilities](#)

## Change Machine Settings Using Web Based Management

Web Based Management is a utility that uses a standard web browser to manage your machine using the Hyper Text Transfer Protocol (HTTP) or Hyper Text Transfer Protocol over Secure Socket Layer (HTTPS).

- [What is Web Based Management?](#)
- [Access Web Based Management](#)
- [Set or Change a Login Password for Web Based Management](#)
- [Set Up Your Machine's Address Book Using Web Based Management](#)

## What is Web Based Management?

Web Based Management is a utility that uses a standard web browser to manage your machine using the Hyper Text Transfer Protocol (HTTP) or Hyper Text Transfer Protocol over Secure Socket Layer (HTTPS). Type your machine's IP address into your web browser to access and change your print server settings.



- We recommend Microsoft Internet Explorer 11/Microsoft Edge for Windows, and Safari 10/11 for Mac. Make sure that JavaScript and Cookies are always enabled in whichever browser you use.
- You must use the TCP/IP protocol on your network and have a valid IP address programmed into the print server and your computer.

XXX-XXXX Logout

brother  
Brother Solution Center

General Address Book Fax Print Scan Administrator Network Bottom

Status

Auto Refresh Interval  
Maintenance Information  
Find Device  
Contact & Location  
Sleep Time  
Auto Power Off  
Volume  
Panel  
Notification

**Status**

**Device Status** Ready

Automatic Refresh  Off  On

**Ink Level**

Cartridge

Internal Ink Reservoir

M C Y BK

**Remaining Page Yield**

Approximate Page Yield (ISO-based) XXXX XXXX XXXX XXXX

M C Y BK

\*The remaining page yields are approximated and may vary depending on the type of pages printed.

Web Language Auto

Device Location

Contact :

Location :

- The actual screen may differ from the screen shown above.



### Related Information

- [Change Machine Settings Using Web Based Management](#)

## Access Web Based Management

- We recommend using the HTTPS security protocol when configuring settings using Web Based Management.
- When you use HTTPS for Web Based Management configuration, your browser will display a warning dialog box. To avoid displaying the warning dialog box, you can install a self-signed certificate to use SSL/TLS communication. For more detailed information, see *Related Information*.
- The default login password to manage machine settings is **initpass**. We recommend you change it to protect your machine from unauthorised access.

1. Start your web browser.
2. Type "https://machine's IP address" in your browser's address bar (where "machine's IP address" is the machine's IP address).

For example:

https://192.168.1.2



- If you are using a Domain Name System or enable a NetBIOS name, you can type another name, such as "SharedPrinter" instead of the IP address.

- For example:

https://SharedPrinter

If you enable a NetBIOS name, you can also use the node name.

- For example:

https://brnxxxxxxxxxxxx



The NetBIOS name can be found in the Network Configuration Report.

- For Mac, access Web Based Management by clicking the machine's icon on the **Status Monitor** screen.

3. If the machine prompts you for a password, type it, and then click .

You can now change the print server settings.

If you change the protocol settings, you must restart the machine after clicking **Submit** to activate the configuration.

Every time you access Web Based Management, type the password in the **Login** field, and then click . After configuring the settings, log out by clicking .



### Related Information

- [Change Machine Settings Using Web Based Management](#)

#### Related Topics:

- [Print the Network Configuration Report](#)
- [Monitor Machine Status from Your Computer \(Mac\)](#)
- [Create a Self-signed Certificate](#)
- [Install the Self-signed Certificate for Windows users with Administrator Rights](#)



## Set or Change a Login Password for Web Based Management

We recommend changing the default login password to prevent unauthorised access to Web Based Management.

1. Start your web browser.
2. Type "https://machine's IP address" in your browser's address bar (where "machine's IP address" is the machine's IP address).

For example:

https://192.168.1.2



- If you are using a Domain Name System or enable a NetBIOS name, you can type another name, such as "SharedPrinter" instead of the IP address.

- For example:

https://SharedPrinter

If you enable a NetBIOS name, you can also use the node name.



- For example:

https://brnxxxxxxxxxxxx

The NetBIOS name can be found in the Network Configuration Report.

- For Mac, access Web Based Management by clicking the machine's icon on the **Status Monitor** screen.

3. Do one of the following:

- If you have previously set your own password, type it, and then click .
- If you have not previously set your own password, type **initpass**, and then click .

4. Click the **Administrator** tab.
5. Type the password you want to use in the **Enter New Password** field (8 to 32 characters).
6. Retype the password in the **Confirm New Password** field.
7. Click **Submit**.



### Related Information

- [Change Machine Settings Using Web Based Management](#)

## Set Up Your Machine's Address Book Using Web Based Management

- We recommend using the HTTPS security protocol when configuring settings using Web Based Management.
- When you use HTTPS for Web Based Management configuration, your browser will display a warning dialog box.

1. Start your web browser.
2. Type "https://machine's IP address" in your browser's address bar (where "machine's IP address" is the machine's IP address).

For example:

https://192.168.1.2



- If you are using a Domain Name System or enable a NetBIOS name, you can type another name, such as "SharedPrinter" instead of the IP address.

- For example:

https://SharedPrinter

If you enable a NetBIOS name, you can also use the node name.

- For example:

https://brnxxxxxxxxxxxx

The NetBIOS name can be found in the Network Configuration Report.

- For Mac, access Web Based Management by clicking the machine's icon on the **Status Monitor** screen.

3. If the machine prompts you for a password, type it, and then click .
4. Click the **Address Book** tab.
5. Add or update the Address Book information as needed.
6. Click **Submit**.



### Related Information

- [Change Machine Settings Using Web Based Management](#)

## Change the Machine Settings Using Remote Setup

**Related Models:** MFC-J1300DW

The Remote Setup program lets you configure many of your Brother machine's settings from your computer. When you start Remote Setup, the settings on your Brother machine will be downloaded to your computer and displayed on your screen. If you change the settings on your computer, you can upload them directly to the machine.

- [Remote Setup \(Windows\)](#)
- [Remote Setup \(Mac\)](#)

## Remote Setup (Windows)

- [Set Up the Brother Machine from Your Computer \(Windows\)](#)
- [Set Up the Brother Machine Using ControlCenter4 \(Windows\)](#)
- [Set Up Your Machine's Address Book Using ControlCenter4 \(Windows\)](#)

## Set Up the Brother Machine from Your Computer (Windows)

Related Models: MFC-J1300DW



If Secure Function Lock is set to On, you cannot use Remote Setup.

1. Do one of the following:

- Windows 7

Click  (**Start**) > **All Programs** > **Brother** > **Brother Utilities**.

Click the drop-down list and select your model name (if not already selected). Click **Tools** in the left navigation bar, and then click **Remote Setup**.

- Windows 8 and Windows 10

Launch  (**Brother Utilities**), and then click the drop-down list and select your model name (if not already selected). Click **Tools** in the left navigation bar, and then click **Remote Setup**.

The Remote Setup Program window appears.



When your machine is connected via a Network, type the password if required.

2. Configure the settings as needed.

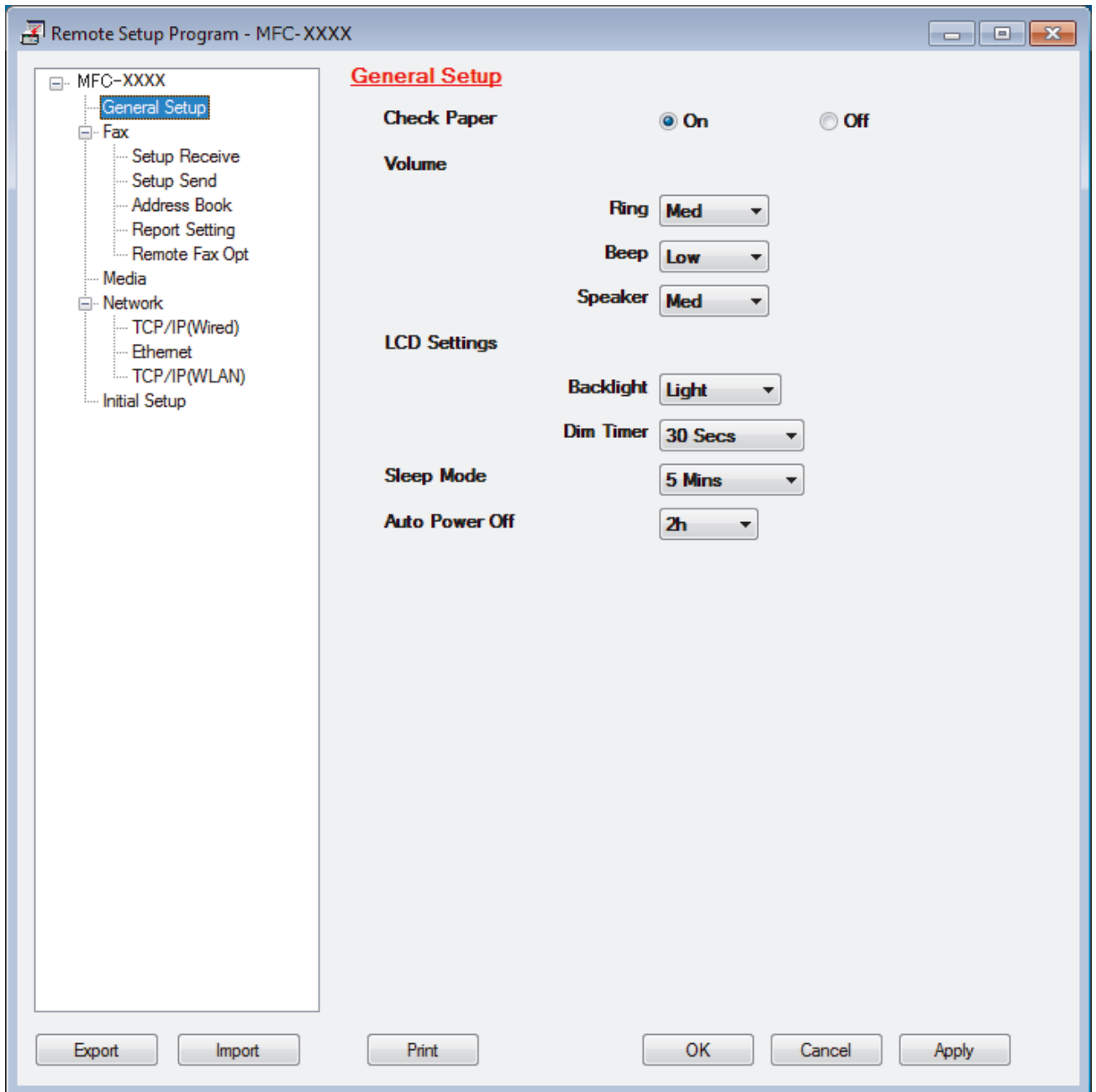

### Export

Click to save the current configuration settings to a file.



Click **Export** to save your address book or all settings for your machine.

### Import

Click to import a file and read its settings.

### Print

Click to print the selected items on the machine. You cannot print the data until it is uploaded to the machine. Click **Apply** to upload the new data to the machine, and then click **Print**.

### OK

Click to start uploading data to the machine, and then exit the Remote Setup Program. If an error message appears, confirm that your data is correct, and then click **OK**.

### Cancel

Click to exit the Remote Setup Program without uploading data to the machine.

---

**Apply**

Click to upload data to the machine without exiting the Remote Setup Program.

3. Click **OK**.
- If your computer is protected by a firewall and is unable to use Remote Setup, you may need to configure the firewall settings to allow communication through port numbers 137 and 161.
  - If you are using Windows Firewall and you installed the Brother software and drivers from the Brother installation disc, the necessary firewall settings have already been set.

**Related Information**

- [Remote Setup \(Windows\)](#)

**Related Topics:**

- [ControlCenter4 \(Windows\)](#)
-

## Set Up the Brother Machine Using ControlCenter4 (Windows)

Related Models: MFC-J1300DW



If Secure Function Lock is set to On, you cannot use Remote Setup.

1. Click the  (ControlCenter4) icon in the task tray, and then click **Open**.
2. Click the **Device Settings** tab.
3. Click the **Remote Setup** button.
4. Configure the settings as needed.

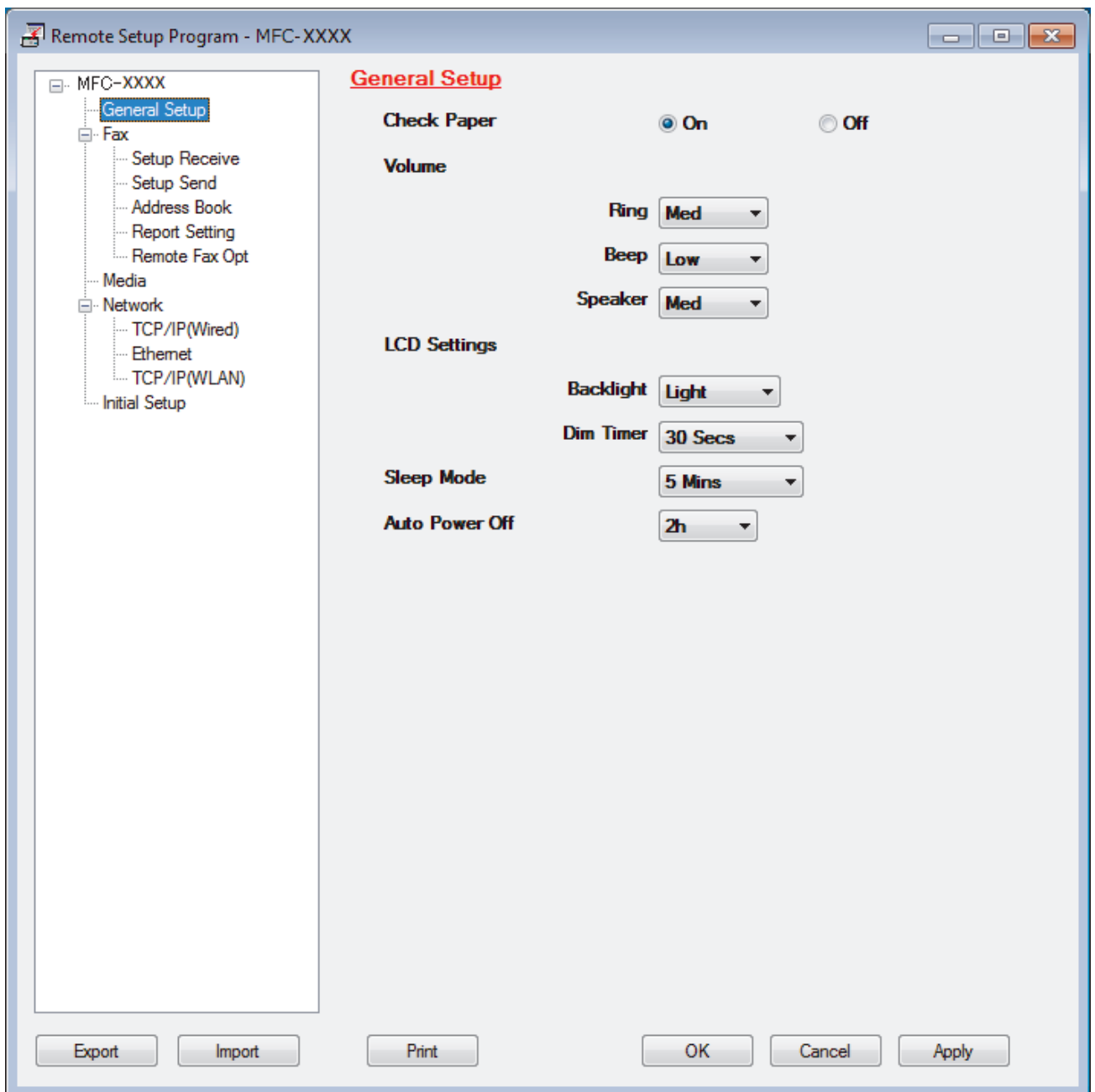

### Export

Click to save the current configuration settings to a file.





---

Click **Export** to save your address book or all settings for your machine.

---

### **Import**

Click to import a file and read its settings.

### **Print**

Click to print the selected items on the machine. You cannot print the data until it is uploaded to the machine. Click **Apply** to upload the new data to the machine, and then click **Print**.

### **OK**

Click to start uploading data to the machine, and then exit the Remote Setup Program. If an error message appears, confirm that your data is correct, and then click **OK**.

### **Cancel**

Click to exit the Remote Setup Program without uploading data to the machine.

### **Apply**

Click to upload data to the machine without exiting the Remote Setup Program.

5. Click **OK**.
- If your computer is protected by a firewall and is unable to use Remote Setup, you may need to configure the firewall settings to allow communication through port numbers 137 and 161.
  - If you are using Windows Firewall and you installed the Brother software and drivers from the Brother installation disc, the necessary firewall settings have already been set.



## **Related Information**

- [ControlCenter4 \(Windows\)](#)
  - [Remote Setup \(Windows\)](#)
-

## Set Up Your Machine's Address Book Using ControlCenter4 (Windows)

**Related Models:** MFC-J1300DW

Use Remote Setup through CC4 to add or change Address Book numbers on your computer.



If Secure Function Lock is set to On, you cannot use Remote Setup.

1. Click the  (**ControlCenter4**) icon in the task tray, and then click **Open**.
2. Click the **Device Settings** tab.
3. Click the **Address Book** button.  
The **Address Book** opens in a Remote Setup window.
4. Add or update the Address Book information as needed.
5. Click **OK**.



### Related Information

- [Remote Setup \(Windows\)](#)

#### Related Topics:

- [ControlCenter4 \(Windows\)](#)

## Remote Setup (Mac)

- [Set Up the Brother Machine with a USB Cable Connection \(Mac\)](#)
- [Set Up Your Machine's Address Book with a USB Cable Connection \(Mac\)](#)

## Set Up the Brother Machine with a USB Cable Connection (Mac)

**Related Models:** MFC-J1300DW

Use Remote Setup to set up your Brother machine with a USB cable connection.

To use Remote Setup, go to your model's **Downloads** page on the Brother Solutions Center at [support.brother.com](http://support.brother.com) and download Remote Setup.

- If Secure Function Lock is set to On, you cannot use Remote Setup.
- Remote Setup for Mac supports USB connections only.

1. In the **Finder** menu bar, click **Go > Applications > Brother**, and then double-click the Remote Setup icon. The Remote Setup Program screen appears.

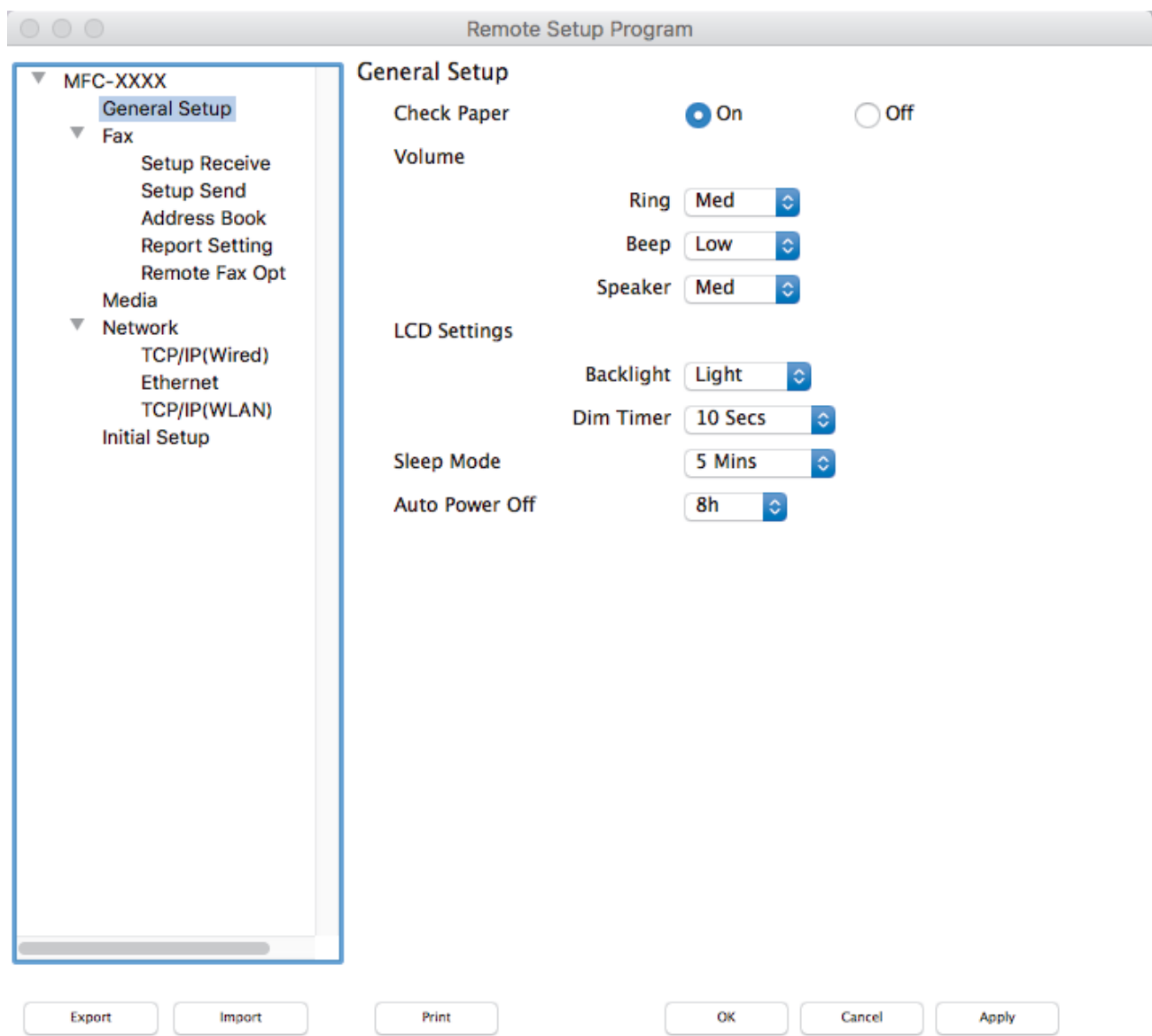

2. Configure the settings as needed.



---

## Export

Click to save the current configuration settings to a file.



---

Click **Export** to save your address book or all settings for your machine.

---

## Import

Click to import a file and read its settings.

## Print

Click to print the selected items on the machine. You cannot print the data until it is uploaded to the machine. Click **Apply** to upload the new data to the machine, and then click **Print**.

## OK

Click to start uploading data to the machine, and then exit the Remote Setup Program. If an error message appears, enter the correct data again, and then click **OK**.

## Cancel

Click to exit the Remote Setup Program without uploading data to the machine.

## Apply

Click to upload data to the machine without exiting the Remote Setup Program.

3. When finished, click **OK**.



## Related Information

- [Remote Setup \(Mac\)](#)
-

## Set Up Your Machine's Address Book with a USB Cable Connection (Mac)

**Related Models:** MFC-J1300DW

Use Remote Setup to add or change Address Book numbers on your computer with a USB cable connection.

To use Remote Setup, go to your model's **Downloads** page on the Brother Solutions Center at [support.brother.com](http://support.brother.com) and download Remote Setup.



- If Secure Function Lock is set to On, you cannot use Remote Setup.
- Remote Setup for Mac supports USB connections only.

1. In the **Finder** menu bar, click **Go > Applications > Brother**, and then double-click the Remote Setup icon. The Remote Setup Program screen appears.
2. In the left menu, click **Address Book** in the **Fax**.
3. Add or update the Address Book information as needed.
4. When finished, click **OK**.



### Related Information

- [Remote Setup \(Mac\)](#)

## Appendix

- [Specifications](#)
- [Supply Specifications](#)
- [Enter Text on Your Brother Machine](#)
- [Information Regarding Recycled Paper](#)
- [Brother Numbers](#)

## Specifications

- >> General Specifications
- >> Document Size Specifications
- >> Print Media Specifications
- >> Fax Specifications
- >> Copy Specifications
- >> PhotoCapture Center Specifications
- >> Scanner Specifications
- >> Printer Specifications
- >> Interface Specifications
- >> Network Specifications
- >> Computer Requirements Specifications

### General Specifications

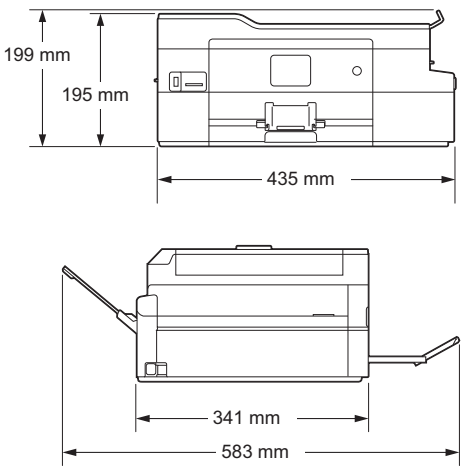
<b>Printer Type</b>		Inkjet
<b>Print Head</b>	<b>Mono</b>	Piezo with 210 nozzles x 1
	<b>Colour</b>	<ul style="list-style-type: none"> <li>• DCP-J1100DW/MFC-J1300DW</li> <li>Piezo with 210 nozzles x 3</li> </ul>
<b>Memory Capacity</b>		128 MB
<b>Liquid Crystal Display (LCD) <sup>1</sup></b>		<ul style="list-style-type: none"> <li>• DCP-J1100DW/MFC-J1300DW</li> <li>2.7 in. (67.5 mm) TFT Colour Touchscreen LCD</li> </ul>
<b>Power Source</b>		AC 220 to 240 V 50/60 Hz
<b>Power Consumption <sup>2</sup></b>		<ul style="list-style-type: none"> <li>• DCP-J1100DW</li> <li><b>Copying <sup>3</sup></b>: Approx. 20 W</li> <li><b>Ready <sup>4</sup></b>: Approx. 3.5 W</li> <li><b>Sleep <sup>4</sup></b>: Approx. 0.9 W</li> <li><b>Power Off <sup>4 5</sup></b>: Approx. 0.2 W</li> <li>• MFC-J1300DW</li> <li><b>Copying <sup>3</sup></b>: Approx. 20 W</li> <li><b>Ready <sup>4</sup></b>: Approx. 4.0 W</li> <li><b>Sleep <sup>4</sup></b>: Approx. 1.3 W</li> <li><b>Power Off <sup>4 5</sup></b>: Approx. 0.2 W</li> </ul>
<b>Dimensions</b>		<ul style="list-style-type: none"> <li>• DCP-J1100DW</li> </ul> 



			<ul style="list-style-type: none"> <li>MFC-J1300DW</li> </ul>
<b>Weights</b>			<ul style="list-style-type: none"> <li>DCP-J1100DW 8.8 kg</li> <li>MFC-J1300DW 8.8 kg</li> </ul>
<b>Noise Level</b>	<b>Sound Pressure</b>	<b>Operating</b>	50 dB (A) (Approx.) <sup>6</sup>
	<b>Sound Power</b> <sup>7</sup>	<b>Printing</b> <sup>8</sup>	<ul style="list-style-type: none"> <li>DCP-J1100DW LWAd =6.35 B(A) (Mono)</li> <li>MFC-J1300DW LWAd =6.35 B(A) (Mono)</li> <li>DCP-J1100DW LWAd =6.28 B(A) (Colour)</li> <li>MFC-J1300DW LWAd =6.28 B(A) (Colour)</li> </ul>
<b>Temperature</b>	<b>Operating</b>		10 to 35 °C
	<b>Best Print Quality</b>		20 to 33 °C
<b>Humidity</b>	<b>Operating</b>		20 to 80% (without condensation)
	<b>Best Print Quality</b>		20 to 80% (without condensation)
<b>Automatic Document Feeder (ADF)</b>			Up to 20 pages Paper: 80 g/m <sup>2</sup>

1 Measured diagonally

2 Measured when the machine is connected to the USB interface. Power consumption varies slightly depending on the usage environment or part wear.

3 When using ADF, single-sided printing, resolution: standard / document: ISO/IEC 24712 printed pattern.

4 Measured according to IEC 62301 Edition 2.0.

5 Even when the machine is turned off, it will automatically turn itself on periodically for print head maintenance, and then turn itself off.

6 Noise depends on printing conditions.

7 Measured in accordance with the method described in RAL-UZ205.

8 <Print speed>

DCP-J1100DW: 12 ipm (Mono) / 10 ipm (Colour)

MFC-J1300DW: 12 ipm (Mono) / 10 ipm (Colour)

These print speeds were measured in accordance with the Blue Angel (RAL-UZ205) specification.

## Document Size Specifications

<b>Document Size</b>	<b>ADF Width</b>	148 to 215.9 mm
	<b>ADF Length</b> <sup>1</sup>	148 to 355.6 mm
	<b>Scanner Glass Width</b>	Max. 215.9 mm

<b>Document Size</b>	<b>Scanner Glass Length</b>	Max. 297 mm
----------------------	-----------------------------	-------------

<sup>1</sup> Documents that are longer than 297 mm must be fed one page at a time.

## Print Media Specifications

<b>Paper Input</b>	<b>Paper Tray</b>	<b>Paper Type</b> <sup>1</sup>	Plain Paper, Inkjet Paper (coated paper), Glossy Paper, Recycled Paper
		<b>Paper Size</b>	A4, Letter, Executive, A5, A6, Envelopes (C5, Com-10, DL, Monarch), Photo (10 x 15 cm), Photo 2L (13 x 18 cm), Index card (13 x 20 cm)
		<b>Maximum Paper Capacity</b>	Up to 150 sheets of 80 g/m <sup>2</sup> plain paper
	<b>Manual Feed Slot</b>	<b>Paper Type</b> <sup>1</sup>	Plain Paper, Inkjet Paper (coated paper), Glossy Paper, Recycled Paper
		<b>Paper Size</b>	A4, Letter, Executive, A5, A6, Envelopes (C5, Com-10, DL, Monarch), Photo (10 x 15 cm), Photo L (9 x 13 cm), Photo 2L (13 x 18 cm), Index card (13 x 20 cm)
		<b>Maximum Paper Capacity</b>	Up to 1 sheet
<b>Paper Output</b> <sup>1</sup>		Up to 50 sheets of 80 g/m <sup>2</sup> Plain Paper (face up print delivery to the output paper tray)	

<sup>1</sup> For glossy paper, remove printed pages from the output paper tray immediately after they exit the machine to avoid smudging.

## Fax Specifications



This feature is available for MFC models.

<b>Compatibility</b>	ITU-T Group 3
<b>Modem Speed</b>	Automatic Fallback: 14,400 bps
<b>Scanning Width</b> (Single-sided document)	ADF: 208 mm (A4) Scanner Glass: 204 mm (A4)
<b>Printing Width</b>	204 mm (A4)
<b>Greyscale</b>	Monochrome: 8 bit (256 levels) Colour: 24 bit (8 bit per colour/256 levels)
<b>Resolution (Horizontal)</b>	203 dpi
<b>Resolution (Vertical)</b>	Standard: 98 dpi (Mono) 196 dpi (Colour)
	Fine: 196 dpi (Mono) 196 dpi (Colour)
	Superfine: 392 dpi (Mono)
	Photo: 196 dpi (Mono)
<b>Address Book</b>	• MFC-J1300DW 100 names x 2 numbers
<b>Groups</b>	Up to 6

<b>Broadcasting</b>	<ul style="list-style-type: none"> <li>MFC-J1300DW 250 (200 Address Book/50 Manual Dial)</li> </ul>
<b>Automatic Redial</b>	3 times at 5 minute intervals
<b>Memory Transmission</b>	<ul style="list-style-type: none"> <li>MFC-J1300DW Up to 180 pages <sup>1</sup></li> </ul>
<b>Out of Paper Reception</b>	<ul style="list-style-type: none"> <li>MFC-J1300DW Up to 180 pages <sup>1</sup></li> </ul>

<sup>1</sup> 'Pages' refers to the 'ITU-T Test Chart #1' (a typical business letter, Standard resolution, MMR code).

## Copy Specifications

<b>Colour/Monochrome</b>	Yes/Yes
<b>Copy Width</b>	204 mm <sup>1</sup>
<b>Multiple Copies</b>	Stacks/Sorts up to 99 pages
<b>Enlarge/Reduce</b>	25% to 400% (in increments of 1%)
<b>Resolution</b>	Prints up to 1200 × 2400 dpi

<sup>1</sup> When copying on A4 size paper.

## PhotoCapture Center Specifications



This function is available for DCP-J1100DW/MFC-J1300DW.

<b>Compatible Media</b> <sup>1</sup>	<ul style="list-style-type: none"> <li>MultiMediaCard (32 MB - 2 GB)</li> <li>MultiMediaCard plus (128 MB - 4 GB)</li> <li>MultiMediaCard mobile with Adapter (64 MB - 1 GB)</li> <li>SD Memory Card (16 MB - 2 GB)</li> <li>miniSD with Adapter (16 MB - 2 GB)</li> <li>microSD with Adapter (16 MB - 2 GB)</li> <li>SDHC Memory Card (4 GB - 32 GB)</li> <li>miniSDHC with Adapter (4 GB - 32 GB)</li> <li>microSDHC with Adapter (4 GB - 32 GB)</li> <li>SDXC Memory Card (48 GB - 256 GB)</li> <li>USB Flash drive <sup>2 3</sup></li> </ul>	
<b>Photo</b>	<b>Resolution</b>	<ul style="list-style-type: none"> <li>DCP-J1100DW/MFC-J1300DW Up to 1200 x 6000 dpi</li> </ul>
	<b>Paper Type</b>	Plain Paper, Inkjet Paper (coated paper), Glossy Paper, Brother BP71 paper
	<b>Paper Size</b>	A4, Letter, Photo (10 x 15 cm), Photo 2L (13 x 18 cm)
	<b>File Format</b>	JPEG (Progressive JPEG format is not supported)
<b>Scan to Media</b>	<b>File Format</b>	JPEG, PDF (Colour, Grey) TIFF, PDF (Monochrome)

<sup>1</sup> Memory cards, adapters and USB Flash drives are not included.

<sup>2</sup> The USB flash drive feature is available only for certain models.

<sup>3</sup> Hi-Speed USB 2.0. USB Mass Storage standard up to 256 GB. Supported formats: FAT12/FAT16/FAT32/exFAT

## Scanner Specifications

<b>Colour/Monochrome</b>	Yes/Yes
--------------------------	---------

<b>TWAIN Compliant</b>	Yes (Windows 7 SP1 / Windows 8 / Windows 8.1 / Windows 10) (macOS v10.11.6 / 10.12.x / 10.13.x)
<b>WIA Compliant</b>	Yes (Windows 7 SP1 / Windows 8 / Windows 8.1 / Windows 10)
<b>Colour Depth</b>	30 bit colour processing (Input) 24 bit colour processing (Output)
<b>Greyscale</b>	10 bit colour processing (Input) 8 bit colour processing (Output)
<b>Resolution</b>	Up to 19200 × 19200 dpi (interpolated) <sup>1</sup> (from Scanner Glass) Up to 1200 × 2400 dpi (optical) (from ADF) <sup>2</sup> Up to 1200 × 600 dpi (optical)
<b>Scanning Width and Length</b> (Single-sided document)	(Scanner Glass) Width: Up to 213.9 mm Length: Up to 295 mm (ADF) <sup>2</sup> Width: Up to 213.9 mm Length: Up to 353.6 mm

<sup>1</sup> Maximum 1200 × 1200 dpi scanning with the WIA driver in Windows 7 SP1, Windows 8, Windows 8.1 and Windows 10 (resolution up to 19200 × 19200 dpi can be selected using the scanner utility).

<sup>2</sup> ADF models only

## Printer Specifications

<b>Resolution</b>	• DCP-J1100DW/MFC-J1300DW Up to 1200 × 6000 dpi	
<b>Printing Width</b> <sup>1</sup>	204 mm [210 mm (borderless)] <sup>2</sup>	
<b>Borderless</b> <sup>3</sup>	A4, Letter, A6, Photo (10 x 15 cm), Photo L (9 x 13 cm), Photo 2L (13 x 18 cm), Index card (13 x 20 cm)	
<b>Automatic 2-sided</b>	<b>Paper Type</b>	Plain Paper, Recycled Paper
	<b>Paper Size</b>	A4, Letter, Executive, A5
<b>Print Speed</b>	For detailed specifications, visit <a href="http://www.brother.com">www.brother.com</a> .	

<sup>1</sup> When printing on A4 size paper.

<sup>2</sup> When the Borderless feature is set to On.

<sup>3</sup> Photo 2L-size paper is only supported by some models.

## Interface Specifications

<b>USB</b> <sup>1 2</sup>	Use a USB 2.0 interface cable that is no longer than 2 m.
<b>LAN</b> (MFC-J1300DW)	Use an Ethernet UTP cable category 5 or greater.
<b>Wireless LAN</b>	IEEE 802.11b/g/n (Infrastructure) IEEE 802.11g/n (Wi-Fi Direct)
<b>NFC</b> (MFC-J1300DW)	Yes

<sup>1</sup> Your machine has a USB 2.0 Hi-Speed interface. The machine can also be connected to a computer that has a USB 1.1 interface.

2 Third party USB ports are not supported.

## Network Specifications



- (DCP-J1100DW)  
You can connect your machine to a network for Network Printing, Network Scanning, and to access photos over a network connection.
- (MFC-J1300DW)  
You can connect your machine to a network for Network Printing, Network Scanning, PC-Fax Send, PC-Fax Receive (Windows only), Remote Setup (Windows only), and to access photos over a network connection.
- Brother **BRAdmin Light** (Windows only) is available as a download from Brother Solutions Center. Go to your model's **Downloads** page on the Brother Solutions Center at [support.brother.com](http://support.brother.com) and download the software.
- (Windows) If you require more advanced machine management, use the latest version of Brother **BRAdmin Professional**. Go to your model's **Downloads** page on the Brother Solutions Center at [support.brother.com](http://support.brother.com) and download the software.

<b>Network Security (Wired)</b> <sup>1</sup>		SMTP-AUTH, SSL/TLS (IPPS, HTTPS, SMTP), SNMP v3, 802.1x (EAP-MD5, EAP-FAST, PEAP, EAP-TLS, EAP-TTLS), Kerberos, IPsec
<b>Network Security (Wireless)</b>		SMTP-AUTH, SSL/TLS (IPPS, HTTPS, SMTP), SNMP v3, 802.1x (LEAP, EAP-FAST, PEAP, EAP-TLS, EAP-TTLS), Kerberos, IPsec
<b>Wireless Network Security</b>		SSID (32 characters), WEP 64/128 bit, WPA-PSK (TKIP/AES), WPA2-PSK (TKIP/AES)
<b>Wireless Setup Support Utility</b>	<b>WPS</b>	Yes

<sup>1</sup> Supported models only

## Computer Requirements Specifications

### Supported Operating Systems And Software Functions

Computer Platform & Operating System Version		PC Interface			Processor	Hard Disk Space to Install	
		USB <sup>1</sup>	10/100 Base-TX (Ethernet) <sup>2</sup>	Wireless 802.11b/g/n		For Drivers	For Applications (Including Drivers)
Windows Operating System	Windows 7 SP1 <sup>3 4</sup>	Printing PC Fax <sup>5</sup> Scanning Removable Disk (USB or Memory Card) <sup>6</sup>			32 bit (x86) or 64 bit (x64) processor	650 MB	1.3 GB
	Windows 8 <sup>3 4</sup>						
	Windows 8.1 <sup>3 4</sup>						
	Windows 10 Home <sup>3 4</sup>						
	Windows 10 Pro <sup>3 4</sup>						
	Windows 10 Education <sup>3 4</sup>						

	Windows 10 Enterprise <sup>3 4</sup>				
	Windows Server 2008	N/A	Printing		50 MB
	Windows Server 2008 R2			64 bit (x64) processor	
	Windows Server 2012				
	Windows Server 2012 R2				
	Windows Server 2016				
Mac Operating System	macOS v10.11.6 macOS v10.12.x macOS v10.13.x	Printing PC-Fax (Send) <sup>5</sup> Scanning Removable Disk (USB or Memory Card) <sup>6</sup>		Intel® Processor	80 MB
					550 MB

1 Third party USB ports are not supported.

2 MFC-J1300DW only

3 For WIA, 1200 x 1200 resolution. Brother Scanner Utility enables enhancing up to 19200 x 19200 dpi.

4 Nuance™ PaperPort™ 14SE supports Windows 7 SP1, Windows 8, Windows 8.1, Windows 10 Home, Windows 10 Pro, Windows 10 Education and Windows 10 Enterprise.

5 PC-Fax supports black and white only. (MFC models)

6 DCP-J1100DW/MFC-J1300DW only

For the latest driver updates, go to your model's **Downloads** page on the Brother Solutions Center at [support.brother.com](http://support.brother.com) and download **Full Driver & Software Package**.

All trademarks, brand and product names are the property of their respective companies.



## Related Information

- [Appendix](#)

## Supply Specifications

<b>Ink</b>	The machine uses individual Black, Yellow, Cyan and Magenta ink cartridges that are separate from the print head assembly.
<b>Service Life of Ink Cartridge</b>	The first time you install a set of ink cartridges the machine will use an amount of ink to fill the ink delivery tubes for high quality printouts. This process will only happen once. After this process is complete the cartridges provided with your machine will have a lower yield than LC3235 cartridges (approximately 90% for Black and 80% for colour <sup>1</sup> ). With all following ink cartridges you can print the specified number of pages.
<b>Replacement Supplies</b>	<Black> LC3235XLBK <Yellow> LC3235XLY <Cyan> LC3235XLC <Magenta> LC3235XLM Black - Approximately 6000 pages <sup>1</sup> Yellow, Cyan and Magenta - Approximately 5000 pages <sup>1</sup>
	<Black> LC3233BK <Yellow> LC3233Y <Cyan> LC3233C <Magenta> LC3233M Black - Approximately 3000 pages <sup>1</sup> Yellow, Cyan and Magenta - Approximately 1500 pages <sup>1</sup>

<sup>1</sup> All replacement cartridges will provide approximate page yield stated in accordance with ISO/IEC 24711. For more page yield information, see [www.brother.com/pageyield](http://www.brother.com/pageyield).



### Related Information



- [Appendix](#)

## Enter Text on Your Brother Machine

- The characters that are available may differ depending on your country.
- The keyboard layout may differ depending on the function you are setting.

When you need to enter text on your Brother machine, a keyboard will appear on the touchscreen.





- Press  to cycle between letters, numbers and special characters.
- Press  to cycle between lowercase and uppercase letters.
- To move the cursor to the left or right, press ◀ or ▶.

### Inserting spaces

- To enter a space, press [Space]. Or, you can press ▶ to move the cursor.

### Making corrections

- If you entered an incorrect character and want to change it, press ◀ or ▶ to highlight the incorrect character. Press , and then enter the correct character.
- To insert a character, press ◀ or ▶ to move the cursor to the correct place, and then enter the character.
- Press  for each character you want to erase, or press and hold  to erase all the characters.

## ✓ Related Information

- [Appendix](#)

### Related Topics:

- [Send the Same Fax to More than One Recipient \(Broadcasting\)](#)
- [Store Address Book Numbers from Outgoing Calls](#)
- [Store Address Book Numbers from Caller ID History](#)
- [Change a Broadcasting Group Name](#)
- [Set Your Station ID](#)
- [Change or Delete Shortcuts](#)



## Information Regarding Recycled Paper

- Recycled paper is of the same quality as paper made from original forest sources. Standards governing modern recycled paper ensure that it meets the highest quality requirements for different printing processes. The imaging equipment supplied by Brother is suitable for using with recycled paper meeting the EN 12281:2002 standard.
- Purchasing recycled paper saves natural resources and promotes the circular economy. Paper is made using cellulose fibres from wood. Collecting and recycling paper extends the life of fibres over multiple life cycles, making the best use of the resources.
- The recycled paper production process is shorter. The fibres have already been processed, so less water and energy, and fewer chemicals are used.
- Paper recycling has the benefit of saving carbon by diverting paper products from alternative disposal routes such as landfill and incineration. Landfill waste emits methane gas, which has a powerful greenhouse effect.



### Related Information

- [Appendix](#)

## Brother Numbers

### IMPORTANT

For technical help, you must call Brother Customer Service or your local Brother Dealer.

- >> [FAQs \(Frequently Asked Questions\)](#)
- >> [Customer Service](#)

### FAQs (Frequently Asked Questions)

The Brother Solutions Center is our one-stop resource for all your Machine needs. Download the latest software and utilities and read **FAQs & Troubleshooting** tips to learn how to get the most from your Brother product.

Check here for Brother driver updates, too.

[support.brother.com](http://support.brother.com)

### Customer Service

Visit [global.brother/gw](http://global.brother/gw) for contact information on your local Brother office.

### Service centre locations

For service centres in Europe, contact your local Brother Office. Contact information for European offices can be found at [global.brother/gw](http://global.brother/gw) and selecting your country.

#### Internet Addresses

Brother Global Web Site: [global.brother/gw](http://global.brother/gw)

For Frequently Asked Questions (FAQs), Product Support and Technical Questions, and Driver Updates and Utilities:

[support.brother.com](http://support.brother.com)



### Related Information

- [Appendix](#)

brother



UK  
Version B