



# User's Guide

**PT-D610BT**

## Table of Contents

<b>Before You Use Your Label Printer</b> .....	<b>1</b>
Definitions of Notes .....	2
General Precautions .....	3
Trademarks and Licences .....	4
Important Note .....	5
<b>Set Up Your Label Printer</b> .....	<b>6</b>
Parts Description.....	7
LCD Overview .....	8
Keyboard Overview.....	10
Connect the AC Adapter .....	12
Install Batteries.....	13
Insert Tape Cassette .....	15
Turn the Label Printer On/Off.....	16
Set Language.....	17
Set Measurement Units.....	18
Set Auto Power-Off Time .....	19
Enable or Disable Bluetooth.....	20
Turn Tape Colour Detection On/Off.....	21
Feed Tape .....	22
Adjust Display Brightness .....	23
Set Input Mode.....	24
<b>Install Software</b> .....	<b>25</b>
Install the Printer Driver and Software on a Computer (Windows).....	26
Available Applications.....	27
Connect the Label Printer to a Computer.....	28
Connect the Label Printer to a Computer Using a USB Cable.....	29
<b>Edit a Label</b> .....	<b>30</b>
Add Text to Your Label .....	31
Add a New Line of Text to Your Label .....	32
Add a New Block of Text to Your Label .....	33
Delete Text .....	34
Insert a Tab .....	35
Change the Tab Length .....	36
Use Text Reminder to Autocomplete Common Words.....	37
Clear Text Reminder Memory .....	38
Enable or Disable Text Reminder.....	39
Enter Symbols.....	40
Enter Symbols Using the Symbol Function .....	41
Set Symbol History .....	42
Symbol Options .....	43
Enter Accented Characters .....	46
Accented Character Options .....	47
Set Character Attributes.....	49
Apply Character Attributes to a Character.....	50
Apply Character Attributes to a Line of Text.....	51

Attribute Setting Options .....	52
Set Auto Fit Style.....	54
Set Label Length .....	55
Set Frames.....	56
Use Auto Format Layouts .....	59
Use Templates.....	60
Template Options .....	62
Use Block Layouts .....	65
Block Layout Options .....	67
Create Tables.....	71
Create a Barcode Label .....	73
Create and Print Barcodes .....	74
Edit or Delete a Barcode and Barcode Data .....	77
Use the Time and Date Function.....	78
Set the Time and Date.....	79
Set the Time and Date Format .....	80
Set the Timestamp and Add the Time and Date to a Label.....	82
Change or Delete the Time and Date Settings.....	84
<b>Print Labels.....</b>	<b>85</b>
Preview Labels.....	86
Print Labels .....	87
Sequential Printing .....	88
Mirror Printing.....	89
Select a Cut Option.....	90
Tape Cutting Options.....	91
Adjust the Label Length .....	93
Print Transferred Templates.....	94
Edit and Print Transferred Templates .....	95
Print Transferred Templates from the Database.....	96
Delete a Transferred Template .....	98
<b>Use the File Memory .....</b>	<b>99</b>
Save Label Files.....	100
Print, Open, Delete, or Mark a Saved Label .....	101
<b>Create and Print Labels Using Your Computer .....</b>	<b>102</b>
Create Labels Using P-touch Editor (Windows).....	103
Create Labels and Print Using P-touch Editor (Mac).....	105
Main Window of P-touch Editor (Mac).....	106
Print Labels Using the Printer Driver (Windows).....	107
<b>Print Labels Using Mobile Devices.....</b>	<b>108</b>
Install the Brother iPrint&Label App .....	109
Create Labels and Print Using Mobile Devices.....	110
<b>Transfer Templates to the Printer (P-touch Transfer Manager) (Windows) .....</b>	<b>111</b>
Transfer Templates to the Printer Using P-touch Transfer Manager (Windows).....	112
Notes on Using P-touch Transfer Manager (Windows).....	113
About Transferring Templates from the Computer to the Printer (Windows).....	114
Back up Templates or Other Data Saved in the Printer (Windows).....	122





Delete Printer Data (Windows).....	123
Create Transfer Files and Transfer Package Files (Windows).....	124
Distribute Templates to be Transferred to Users Without Using P-touch Transfer Manager (Windows) ...	126
<b>Store and Manage Templates (P-touch Library).....</b>	<b>130</b>
Edit Templates Using P-touch Library (Windows).....	131
Print Templates Using P-touch Library (Windows).....	132
Search Templates Using P-touch Library (Windows).....	133
<b>Routine Maintenance .....</b>	<b>135</b>
Maintenance.....	136
<b>Troubleshooting .....</b>	<b>138</b>
If You Are Having Difficulty with Your Label Printer.....	139
Error and Maintenance Messages .....	141
Check the Version Information.....	142
Reset the Label Printer .....	143
Reset Using the LCD.....	144
<b>Appendix.....</b>	<b>145</b>
Specifications .....	146
Brother Help and Customer Support.....	148

## Before You Use Your Label Printer

- [Definitions of Notes](#)
- [General Precautions](#)
- [Trademarks and Licences](#)
- [Important Note](#)

## Definitions of Notes

We use the following symbols and conventions throughout this User's Guide:

 <b>DANGER</b>	DANGER indicates an imminently hazardous situation which, if not avoided, will result in death or serious injuries.
 <b>WARNING</b>	WARNING indicates a potentially hazardous situation which, if not avoided, could result in death or serious injuries.
 <b>CAUTION</b>	CAUTION indicates a potentially hazardous situation which, if not avoided, may result in minor or moderate injuries.
<b>IMPORTANT</b>	IMPORTANT indicates a potentially hazardous situation which, if not avoided, may result in damage to property or loss of product functionality.
<b>NOTE</b>	NOTE specifies the operating environment, conditions for installation, or special conditions of use.
	The tips icon indicates helpful hints and supplementary information.
<b>Bold</b>	Bold style identifies buttons on the machine's control panel or computer screen.
<i>Italics</i>	Italicised style emphasises an important point or refers you to a related topic.
Courier New	Courier New font identifies messages shown on the machine's LCD.



### Related Information

- [Before You Use Your Label Printer](#)

## General Precautions

- Depending on the area, material, and environmental conditions, the label may unpeel or become permanently affixed, and the colour of the label may change or be transferred to other objects. Before affixing the label, check the environmental conditions and the material. Test the label by affixing a small piece of it to an inconspicuous area of the intended surface.
- DO NOT use the machine, components, or supplies in any way or for any purpose not described in this guide. Doing so may result in accidents or damage.
- Use only Brother TZe tapes with the Label Printer. DO NOT use tapes that do not have the  mark.
- Use a soft wipe to clean the Print Head; never touch the Print Head.
- DO NOT try to print if the cassette is empty; it will damage the Print Head.
- DO NOT pull the tape while printing or feeding; it will damage the tape and the Label Printer.
- Any data stored in memory will be lost due to failure, or repair of the printer, or if the batteries discharge completely.
- Printed characters may look different from those displayed in the print preview, as your device's or computer's screen may have a higher resolution than the Label Printer.
- The displayed label length may differ from the actual length of the printed label.
- When power is disconnected for two minutes, all text and format settings will be cleared.
- Be sure to read the instructions provided with Fabric Iron-On Tapes, Extra Strength Adhesive Tapes, or other special tapes and observe all precautions noted in the instructions.



### Related Information

- [Before You Use Your Label Printer](#)

## Trademarks and Licences

- Android is a trademark of Google LLC.
- Google Play and the Google Play logo are trademarks of Google LLC.
- The Bluetooth® word mark and logos are registered trademark owned by Bluetooth SIG, Inc. and any use of such marks by Brother Industries, Ltd. is under license. Other trademarks and trade names are those of their respective owners.
- QR Code is a registered trademark of DENSO WAVE INCORPORATED.
- Mac, iPad, iPhone, and iPod touch are trademarks of Apple Inc.
- QR Code Generating Program Copyright © 2008 DENSO WAVE INCORPORATED.
- Portions of this software are copyright © 2014 The FreeType Project ([www.freetype.org](http://www.freetype.org)). All rights reserved.

**Any trade names and product names of companies appearing on Brother products, related documents and any other materials are all trademarks or registered trademarks of those respective companies.**



### Related Information

- [Before You Use Your Label Printer](#)
-



## Important Note

- The contents of this document and the specifications of this Label Printer are subject to change without notice.
- Brother reserves the right to make changes without notice in the specifications and materials contained herein and shall not be responsible for any damages (including consequential) caused by the reliance on the materials presented, including, but not limited to, typographical and other errors relating to the publications.
- This Label Printer does not support wireless connection.
- Screen images in this document may differ depending on your computer's operating system, your product model, and software version.
- Before using the Label Printer, make sure you read all the documents included with the Label Printer for information about safety and operation.
- The Label Printer shown in the illustrations may be different from your Label Printer.
- The available supplies may vary depending on your country or region.
- We recommend using the latest version of P-touch Editor.
- To keep your Label Printer's performance up to date, visit [support.brother.com](http://support.brother.com) to check for the latest firmware updates. Otherwise, some of your Label Printer's functions may not be available.
- Before giving your Label Printer to anyone else, replacing it, or disposing of it, we strongly recommend resetting it to its factory settings to remove all personal information.



### Related Information

- [Before You Use Your Label Printer](#)
-

## Set Up Your Label Printer

- [Parts Description](#)
- [LCD Overview](#)
- [Keyboard Overview](#)
- [Connect the AC Adapter](#)
- [Install Batteries](#)
- [Insert Tape Cassette](#)
- [Turn the Label Printer On/Off](#)
- [Set Language](#)
- [Set Measurement Units](#)
- [Set Auto Power-Off Time](#)
- [Enable or Disable Bluetooth](#)
- [Turn Tape Colour Detection On/Off](#)
- [Feed Tape](#)
- [Adjust Display Brightness](#)
- [Set Input Mode](#)

## Parts Description

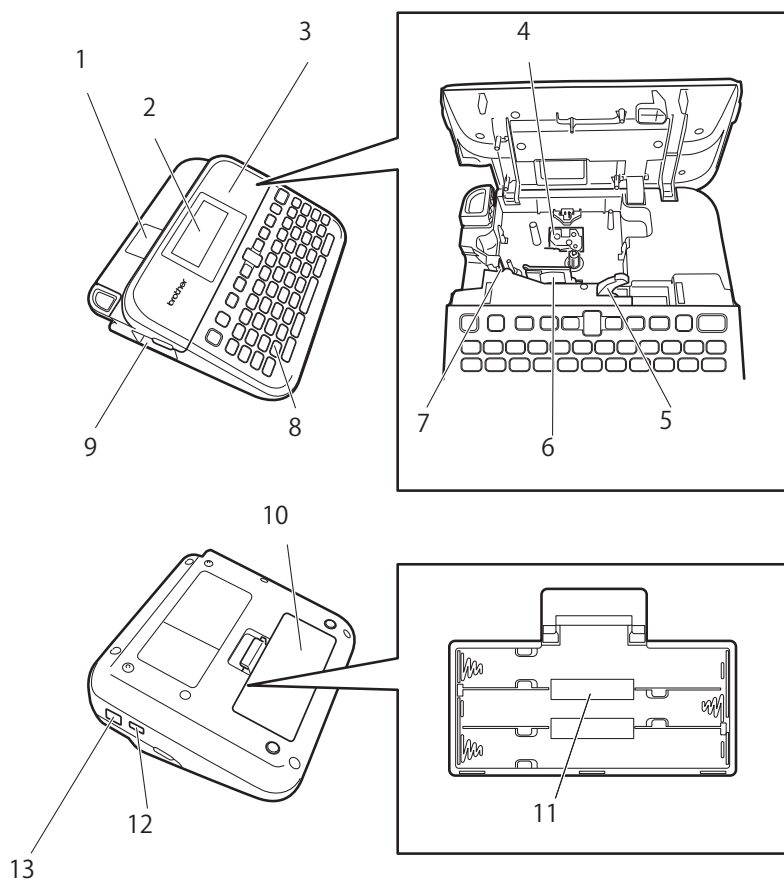

1. Tape Viewer
2. Liquid Crystal Display (LCD)
3. Tape Cassette Compartment Cover
4. Tape Cassette Compartment
5. Release Lever
6. Print Head
7. Tape Cutter
8. Keyboard
9. Tape Exit Slot
10. Battery Compartment Cover
11. Battery Compartment
12. USB Port
13. AC Adapter Socket



### Related Information

- [Set Up Your Label Printer](#)

## LCD Overview

### Print Preview Mode

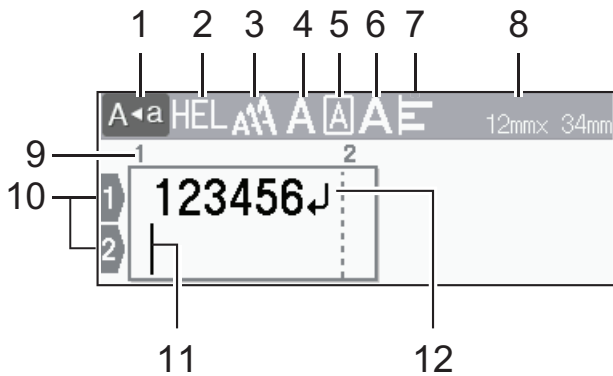

### Label View Mode

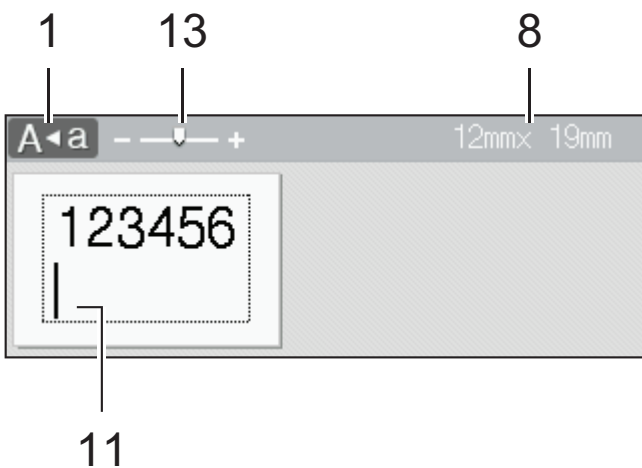

#### 1. Caps mode

Indicates if the caps lock mode is enabled.

#### 2. Current font

Indicates the current font.

#### 3. Character size

Indicates the current character size.

#### 4. Character style

Indicates the current character style.

#### 5. Frame

Indicates if a frame is set.

#### 6. Width

Indicates the character width.

#### 7. Align

Indicates the text alignment.

#### 8. Tape width x Label length

The label length displayed on the LCD may slightly differ from the actual label length when printed.

#### 9. Block number

Indicates the block number.

#### 10. Line number

Indicates line numbers within the label layout.

---

**11. Cursor**

New characters appear to the left of the cursor.

Indicates the current data entry position.

**12. Return mark**

Indicates the end of a line of text.

**13. Scale/Zoom**

Changes the magnification of the preview.

**Related Information**

- [Set Up Your Label Printer](#)

## Keyboard Overview

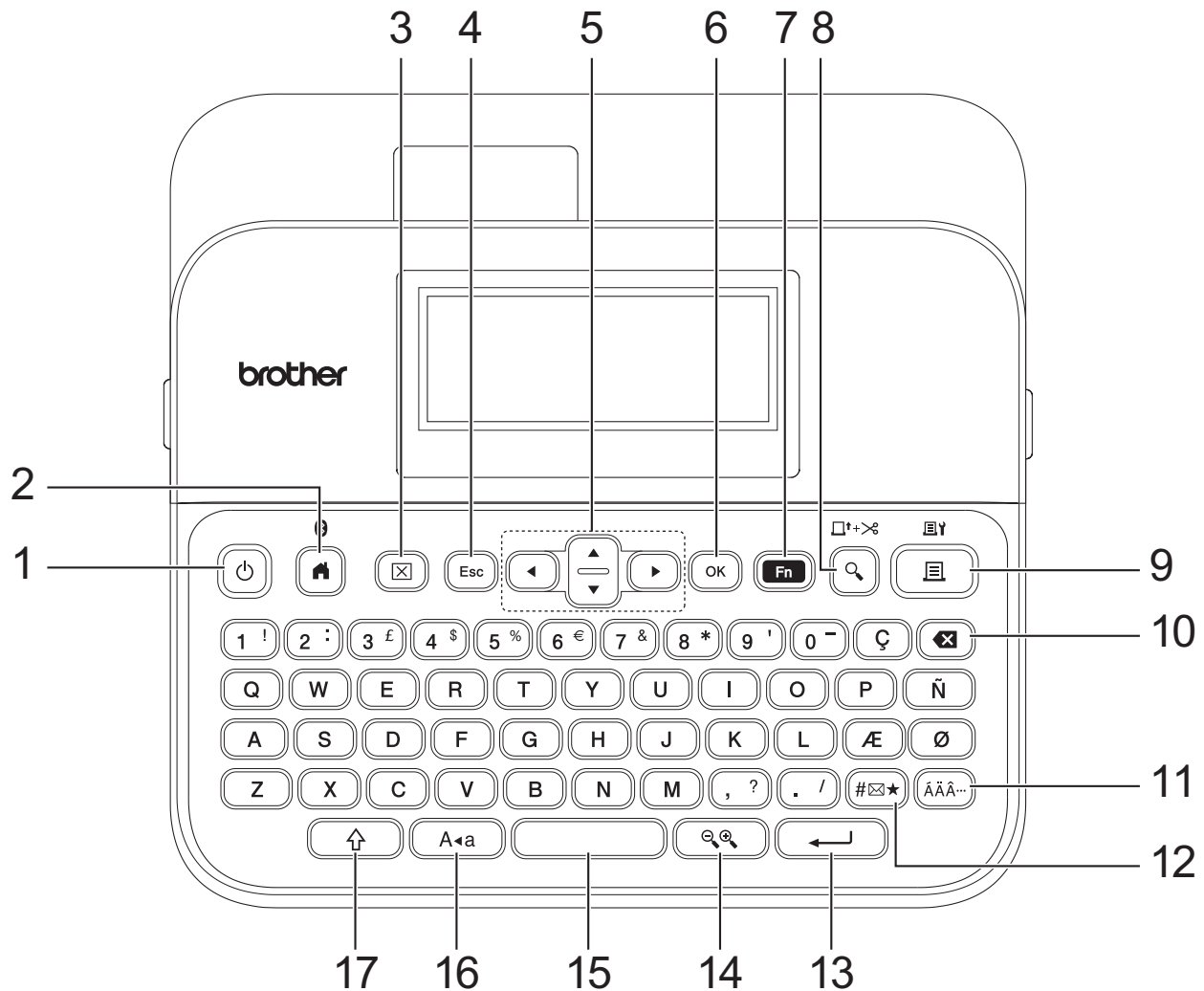

### 1. Power

Press to turn the Label Printer on or off.

### 2. Home/Bluetooth

Press to return to the Home Screen. To turn Bluetooth on or off, press **Home/Bluetooth** and the **Shift** key simultaneously.

### 3. Clear

Press to clear all text and print settings.

### 4. Escape

Press to cancel the current operation.

### 5. Cursor

Press to move the cursor in the direction of the arrow.

### 6. OK

Press to select the displayed option.

### 7. Function

Press to select a function menu.

To display the attributes, press **Function** and the **Shift** key simultaneously.

### 8. Preview/Feed & Cut

Press to view an image of the label before printing.

To feed the Tape, press **Preview/Feed & Cut** and the **Shift** key simultaneously.

---

## 9. Print/Print Options

Press to print.

To set Print Options, press **Print/Print Options** and the **Shift** key simultaneously.

## 10. Backspace

Press to delete any character to the left of the cursor.

## 11. Accent

Press to select and insert an accented character.

## 12. Symbol

Press to select and insert a symbol from the symbols menus.

## 13. Enter

Press to confirm your selection.

## 14. Scale/Zoom

Press to change the magnification of the preview.

## 15. Space

Press to insert a blank space.

Press to return to the default value.

## 16. Caps

Press to use upper-case letters only.

When Caps mode is on, all letters are typed in upper case.

## 17. Shift

Press and hold when pressing a letter or number key to type an upper-case letter or the symbol marked on the number key.

To move the cursor to the beginning of the previous or next block, press **Shift** and the **▲** or **▼** key simultaneously.

To move the cursor to the beginning or end of the current line, press **Shift** and the **◀** or **▶** key simultaneously.



## Related Information

- [Set Up Your Label Printer](#)
-

## Connect the AC Adapter

If connecting a power adapter, use only the AC Adapter, part number AD-E001A, specifically designed for this Label Printer.

1. Insert the AC Adapter cord into the AC Adapter Socket on the side of the Label Printer.
2. Insert the plug into the nearest standard electrical socket.

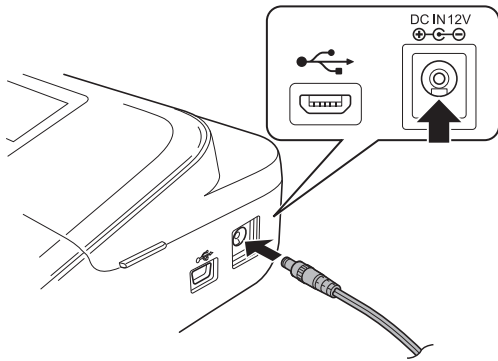

### ✓ Related Information

- [Set Up Your Label Printer](#)



## Install Batteries

To ensure memory backup, we recommend using six new AA alkaline batteries (LR6) along with the AC Adapter.

### NOTE

- To safeguard and back up the Label Printer's memory, when the AC Adapter is unplugged, we recommend having AA alkaline batteries installed in the Label Printer.
- When power is disconnected for more than two minutes, all text and format settings will be cleared. Any text files saved in the memory will also be cleared.
- Remove the batteries if you do not intend to use the Label Printer for an extended period of time.
- Dispose of the batteries at an appropriate collection point, not in the general waste stream. In addition, be sure to observe all applicable federal, state, and local regulations.
- When storing or discarding the batteries, wrap them (for example, with cellophane tape, as illustrated), to prevent them from short-circuiting.

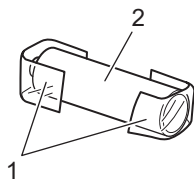

1. Cellophane tape
2. Alkaline battery

1. Open the Battery Compartment Cover.

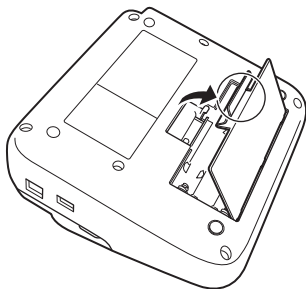

2. Install six new AA alkaline batteries (LR6).  
Make sure they are installed in the correct direction.

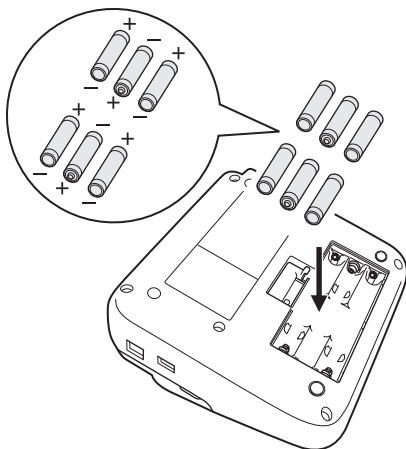

---

3. Close the Battery Compartment Cover.

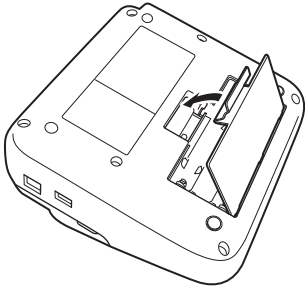

To remove the batteries, reverse the installation procedure.



### Related Information

- [Set Up Your Label Printer](#)

## Insert Tape Cassette

1. Open the Tape Cassette Compartment Cover.

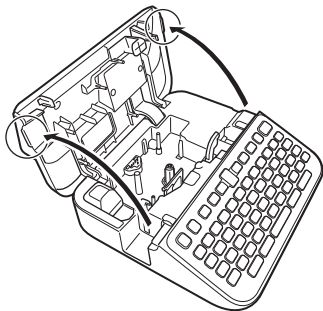

2. Insert the Tape Cassette as illustrated.

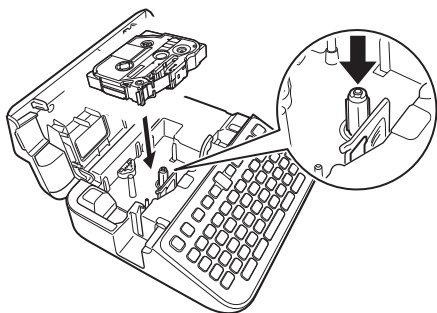

### NOTE

When inserting the Tape Cassette, make sure the tape does not catch on the Print Head.

3. Close the Tape Cassette Compartment Cover.





If you cannot close the Tape Cassette Compartment Cover, make sure the Release Lever is in the 'up' position. If not, lift the Release Lever, and then close the cover.



### Related Information

- [Set Up Your Label Printer](#)

## Turn the Label Printer On/Off

1. To turn the Label Printer on, press .
2. To turn the Label Printer off, press and hold .

To save power and turn the Label Printer off automatically after a specific amount of time, use the Auto Power-Off function.



### Related Information

- [Set Up Your Label Printer](#)

#### Related Topics:

- [Set Auto Power-Off Time](#)
  - [Specifications](#)
-

## Set Language

When you turn the Label Printer on for the first time, the language selection screen appears. Select the language using ◀ or ▶, and then press **OK**.

1. Press .
2. Press ◀ or ▶ to display [Settings], and then press **OK**.
3. Press ▲ or ▼ to display [Language], and then press **OK**.
4. Press ▲ or ▼ to select your language, and then press **OK**.

### Related Information

- [Set Up Your Label Printer](#)
-

## Set Measurement Units

1. Press .
2. Press ◀ or ▶ to display [Settings], and then press **OK**.
3. Press ▲ or ▼ to display [Unit], and then press **OK**.
4. Press ▲ or ▼ to display [inch] or [mm], and then press **OK**.

### Related Information

- [Set Up Your Label Printer](#)
-

## Set Auto Power-Off Time

Your Label Printer has a power saving function that automatically turns the printer off if no key is pressed within a certain time, under certain operating conditions. Regardless of whether you use the AC Adapter or the batteries, you can change the automatic powering-off time.

1. Press .
2. Press ◀ or ▶ to display [Settings], and then press **OK**.
3. Press ▲ or ▼ to display [Auto Power Off], and then press **OK**.
4. Press ▲ or ▼ to display [AC Adapter] or [Battery], and then press **OK**.
5. Press ▲ or ▼ to select one of the following options:

Option	Description
AC Adapter	Off 1hr. 2hr. 4hr. 8hr.
Battery	5min. 10min. 30min.

6. Press **OK**.



### Related Information

- [Set Up Your Label Printer](#)

## Enable or Disable Bluetooth

1. Press .
2. Press ◀ or ▶ to display [Settings], and then press **OK**.
3. Press ◀ or ▶ to display [Bluetooth], and then press **OK**.
4. Press ▲ or ▼ to display [Bluetooth (On/Off)], and then press **OK**.
5. Press ▲ or ▼ to select [On] or [Off], and then press **OK**.

When you select [On], the Bluetooth icon appears on the LCD.



- You can also enable or disable Bluetooth by pressing  and  simultaneously when the Home Screen is displayed.
- Set the Automatic Reconnection mode for Bluetooth to On or Off when you connect the Label Printer to your mobile device.



### Related Information

- [Set Up Your Label Printer](#)



## Turn Tape Colour Detection On/Off

For a more accurate preview of the label you are creating, set the tape colour detection function to [On] in the Label View mode. Your Label Printer will detect the colour of the tape and display the label image on the LCD reflecting that tape colour.

The default setting is [On].

1. Press .
2. Press ◀ or ▶ to display [Settings], and then press **OK**.
3. Press ▲ or ▼ to display [Tape Color], and then press **OK**.
4. Press ▲ or ▼ to select [On] or [Off], and then press **OK**.

### NOTE

The tape colour detection function is not available when using certain Tape Cassettes. In this case, the label image on the LCD is displayed as black text on a white background.





### Related Information

- [Set Up Your Label Printer](#)

#### Related Topics:

- [Set Input Mode](#)

## Feed Tape

1. To feed the tape, press  and .
2. Press ▲ or ▼ to select one of the following options:

Option	Description
Feed & Cut	Select to feed and cut the tape automatically.
Feed Only	Select to feed, but not cut, the tape. Recommended when using Fabric Iron-On Tapes, which should be cut using scissors.

3. Press **OK**.



### Related Information

- [Set Up Your Label Printer](#)

## Adjust Display Brightness

1. Press .
2. Press ◀ or ▶ to display [Settings], and then press **OK**.
3. Press ▲ or ▼ to display [Adjustment], and then press **OK**.
4. Press ▲ or ▼ to display [Display Brightness], and then press **OK**.
5. Press ▲ or ▼ to select your preference, [-2 - +2], and then press **OK**.



### Related Information

- [Set Up Your Label Printer](#)

## Set Input Mode

### Label View Mode

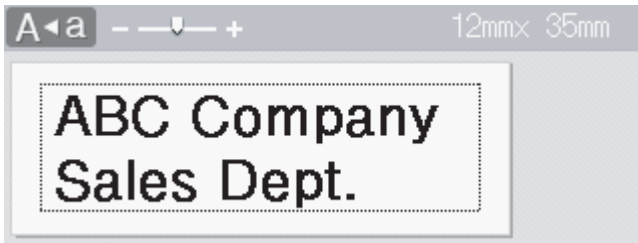

### Print Preview Mode



1. Press .
2. Press **◀** or **▶** to display [Settings], and then press **OK**.
3. Press **▲** or **▼** to display [Input Mode], and then press **OK**.
4. Press **▲** or **▼** to select one of the following options:

Option	Description
Label View	Displays the character attributes and frames you set when creating a label. Press  to change the LCD magnification.
Print Preview	Select if you do not want to view the attributes on the LCD.

5. Press **OK**.

### ✓ Related Information

- [Set Up Your Label Printer](#)

#### Related Topics:

- [Preview Labels](#)

## Install Software

- [Install the Printer Driver and Software on a Computer \(Windows\)](#)
- [Connect the Label Printer to a Computer](#)

## Install the Printer Driver and Software on a Computer (Windows)

To print from your Windows computer, install the printer driver and the Brother P-touch Editor software on your computer.

1. Open your preferred web browser and type [install.brother](http://install.brother) in the address bar.

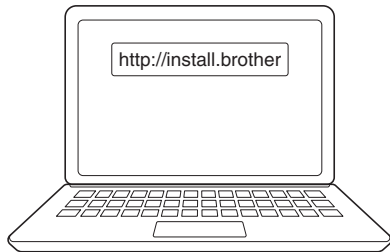

2. Click the **Download** button to download the Software/Documentation Installer.
3. Navigate to your computer's **Downloads** folder, double-click the downloaded installer file, and follow the on-screen instructions.

### NOTE

- When you connect the Label Printer to your computer using Bluetooth, make sure you set the Bluetooth data transfer setting in your operating system to bi-directional.
- Press the required button on the Label Printer for pairing when you confirm the passcode.



### Related Information

- [Install Software](#)
  - [Available Applications](#)

## Available Applications

### Windows

Application	Features
P-touch Editor <sup>1</sup>	Allows you to design and print custom labels using built-in drawing tools to create various font and text styles, import images, and insert barcodes.
P-touch Transfer Manager <sup>2</sup>	Allows you to transfer templates and other data to the Label Printer and save backups of your data on the computer. This application is installed with P-touch Editor.
P-touch Library	Manages and prints P-touch Editor templates. You can use P-touch Library to print templates. This application is installed with P-touch Editor.
P-touch Transfer Express <sup>2</sup>	Allows you to transfer documents to the Label Printer.
P-touch Update Software <sup>2</sup>	Updates software and firmware to the latest version.

<sup>1</sup> The template transfer function is currently available with P-touch Editor 5.4 only. P-touch Editor 6.0 will support this function from a future update.

<sup>2</sup> Available with the USB connection only.

### Mac

Application	Features
P-touch Editor	Allows you to design and print custom labels using built-in drawing tools to create various font and text styles, import images, and insert barcodes.
Transfer Express <sup>1</sup>	Updates firmware to the latest version.

<sup>1</sup> Available with the USB connection only.



### Related Information

- [Install the Printer Driver and Software on a Computer \(Windows\)](#)

## Connect the Label Printer to a Computer

- [Connect the Label Printer to a Computer Using a USB Cable](#)



## Connect the Label Printer to a Computer Using a USB Cable

1. Make sure the Label Printer is turned off before connecting the USB cable.
2. Connect the USB cable to the USB Port on the Label Printer, and then to your computer.

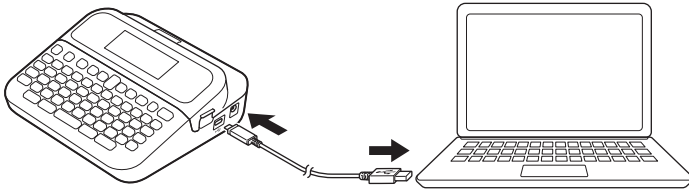

3. Turn the Label Printer on.



### Related Information

- [Connect the Label Printer to a Computer](#)

## Edit a Label

- [Add Text to Your Label](#)
- [Add a New Line of Text to Your Label](#)
- [Add a New Block of Text to Your Label](#)
- [Delete Text](#)
- [Insert a Tab](#)
- [Use Text Reminder to Autocomplete Common Words](#)
- [Enter Symbols](#)
- [Enter Accented Characters](#)
- [Set Character Attributes](#)
- [Set Label Length](#)
- [Use Auto Format Layouts](#)
- [Use Block Layouts](#)
- [Create Tables](#)
- [Create a Barcode Label](#)
- [Use the Time and Date Function](#)

## Add Text to Your Label

1. Press .
2. Press ◀ or ▶ to display [Create Label], and then press **OK**.
3. Type the text or symbols you want (up to 280 alphanumeric characters, including spaces and punctuation marks).



### Related Information

- [Edit a Label](#)
-

## Add a New Line of Text to Your Label

You can add up to seven lines to your labels, depending on the tape you are using. For more information, see *Related Topics*.

1. Move the cursor to the end of the current line.

2. Press .

Line 1



Line 2



Printed Label Result

ABC  
DEF



The maximum number of lines you can add depends on the tape width.

Max Lines	Tape Width
7 lines	24 mm
5 lines	18 mm
3 lines	12 mm
2 lines	9 mm 6 mm
1 line	3.5 mm



### Related Information

- [Edit a Label](#)



#### Related Topics:

- [Specifications](#)

## Add a New Block of Text to Your Label

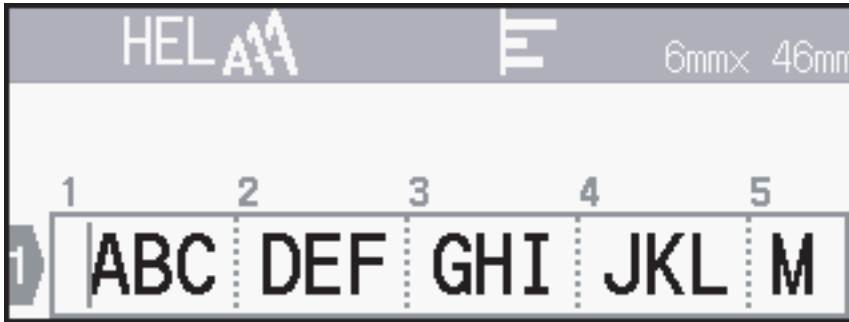
To print labels with multiple, but separate, sections of text, you can insert up to five different text blocks within the same label.



To add a new block of either text or blank lines to the right of your current text, press and hold , and then press  simultaneously.

The cursor moves to the start of the new block.



- To change the character attributes for a block of text, follow the steps for changing character attributes for a line of text.
- There is a maximum of five blocks per label.



### Related Information

- [Edit a Label](#)

## Delete Text

- >> To delete one character at a time:
- >> To delete text but not format settings:
- >> To delete all characters in a specific line:
- >> To delete all characters and all format settings:



### To delete one character at a time:

Press .

### To delete text but not format settings:

1. Press .
2. Press **▲** or **▼** to display [Text Only], and then press **OK**.

### To delete all characters in a specific line:

1. Press **▲** or **▼** to move to the line you want to delete.
2. Press  and  simultaneously.



### To delete all characters and all format settings:

1. Press .
2. Press **▲** or **▼** to display [Text & Format], and then press **OK**.

### Related Information

- [Edit a Label](#)

## Insert a Tab

To insert a tab, place the cursor to the left of the text, and press  and  simultaneously.

The tab symbol () appears on the LCD.



To delete a tab from a label:



Position the cursor to the right of the tab symbol on the text entry screen, and then press .



### Related Information

- [Edit a Label](#)
- [Change the Tab Length](#)

## Change the Tab Length

1. Enter the text you want.
2. Press .
3. Press ▲ or ▼ to display [Tab Length], and then press **OK**.
4. Do one of the following:
  - Press ▲ or ▼ to display 0 - 100 mm, and then press **OK**.
  - Enter the tab length you want using the number keys. When finished, press **OK**.
5. Press  to return to the text entry screen.



### Related Information

- [Insert a Tab](#)



## Use Text Reminder to Autocomplete Common Words

You can save frequently used text or phrases in your Label Printer for quick retrieval and use in your labels. By default, the Text Reminder feature is set to [On].



1. Type a character (for example: "B").
2. Press **OK**.  
The Label Printer displays a list of previously used words beginning with the letter "B", such as "Brother".
3. Press ▲ or ▼ to select the word you want.
4. Press ► to display the entire word if necessary.  
Press ◀ to return to the list of words.
5. Press **OK**.

To close the list of words and return to the text entry screen, press .

### Related Information

- [Edit a Label](#)
  - [Clear Text Reminder Memory](#)
  - [Enable or Disable Text Reminder](#)

## Clear Text Reminder Memory

1. Press .
2. Press ◀ or ▶ to display [Settings], and then press **OK**.
3. Press ▲ or ▼ to display [Text Reminder], and then press **OK**.
4. Press ▲ or ▼ to display [Clear Memory], and then press **OK**.  
The message [Clear all Text Reminder memory?] appears.
5. Press **OK**.



### Related Information

- [Use Text Reminder to Autocomplete Common Words](#)
-

## Enable or Disable Text Reminder

1. Press .
2. Press ◀ or ▶ to display [Settings], and then press **OK**.
3. Press ▲ or ▼ to display [Text Reminder], and then press **OK**.
4. Press ▲ or ▼ to select [On/Off], and then press **OK**.
5. Press ▲ or ▼ to select [On] or [Off], and then press **OK**.



### Related Information

- [Use Text Reminder to Autocomplete Common Words](#)
-

## Enter Symbols

- [Enter Symbols Using the Symbol Function](#)
- [Set Symbol History](#)
- [Symbol Options](#)

## Enter Symbols Using the Symbol Function

1. Press .
2. Press ▲ or ▼ to select a category, and then press **OK**.
3. Press ▲, ▼, ◀, or ▶ to select a symbol, and then press **OK**.



### Related Information

- [Enter Symbols](#)
-

## Set Symbol History

The Symbol History can store up to 30 recently used symbols. By default, the Symbol History feature is set to [On].













1. Press .
2. Press ◀ or ▶ to display [Settings], and then press **OK**.
3. Press ▲ or ▼ to display [Symbol History], and then press **OK**.
4. Press ▲ or ▼ to select [On] or [Off], and then press **OK**.

### Related Information

- [Enter Symbols](#)
-

# Symbol Options

Category	Symbols
Punctuation	. , : ; " ' • ? ! ¿ ¡ - & ~ _ \ / * @ #
BracketArrow	( ) [ ] < > « » [ ] → ← ↑ ↓ ⇨ ⇩ ⇧ ⇩ ↑ ↓ → ← ↙ ↘ ↗ ↖ ↔ ⇌ ↕ ✕ ↺ §
Mathematics	+ - × ÷ ± = ≥ ≤ ≠ ∴ α β γ δ μ Ω Φ Σ α ω 2 3 2 3 ¼ ½ ¾ I II III IV V VI VII VIII IX X
CurrencyUnit	% \$ ¢ € £ ¥ ¢ ° ft. in. m² m³ cc ℓ oz. lb. °F °C
(Number)	① - ⑩⑩
[Number]	▢ - ⑨⑨
Sign	⊘ ⊚ ⚠ ⚡ ⚡ ⚡ ⚡ ⚡ ⚡ ⚡ ⚡ ⚡ ⚡ ⚡ ⚡ ⚡ ♿ ⚠ ⚠ ⚠ ⚠ ⚠ ⚠ ⚠ ⚠ ⚠ ⚠ ⚠ ⚠ ⚠ ⚠ ⚠ ♀ ⚡ ⚡ ⚡ ⚡ ⚡ ⚡ ⚡ ⚡ ⚡ ⚡ ⚡ ⚡ ⚡ ⚡ ⚡
Electronics	💻 🖥️ 📄 🖨️ 📞
Business	✓ ☑️ ☐ ✂️ ✂️ ✂️ ✂️ ✂️ ✂️ ✂️ ✂️ ✂️ ✂️ ✂️ ✂️ 📁 ♻️ 🏭 🏭 🏭 🏭 🏭 🏭 🏭 🏭 🏭 🏭 🏭 🏭 🏭
Healthcare	🏥 🏥

Category	Symbols
Electrical	
Tools	
Garden	
Craft/Baby	
Music	
Animal	
Foods	
Nature/Earth	
Event	
Vehicle	
Wardrobe	
Sports	
Family	



Category	Symbols
Emoji	
Pictograph	
Astrology	

### ✓ Related Information

- [Enter Symbols](#)

## Enter Accented Characters

1. Enter the character you want.
2. Press .
3. Press ▲ or ▼ to select the accented character, and then press **OK**.



### Related Information

- [Edit a Label](#)
    - [Accented Character Options](#)
-

## Accented Character Options

The accented characters displayed on the LCD depend on your language.

Character	Accented Characters
a	á à â ä æ ã å ä ã
A	Á À Â Ä Æ Ã Å Ä Æ
c	ç ċ ċ
C	Ç Ć Ć
d	d' ð đ
D	Ď Ď
e	é è ê ë ě ě è ē
E	É È Ê Ë Ě Ě Ě Ě
g	ğ ğ
G	Ģ Ģ
i	í ì î ï ĵ ĵ ĵ
I	Í Ì Î Ï Ĵ Ĵ Ĵ
k	ķ
K	Ķ
l	ł ł ł ł
L	Ł Ł Ł Ł
n	ñ ñ ñ ñ
N	Ñ Ñ Ñ Ñ
o	ó ò ô ø ö õ œ ö
O	Ó Ò Ô Ø Ö Õ Œ Ö
r	ř ř ř
R	Ř Ř Ř
s	š š š š š
S	Š Š Š Š Š
t	t' t t
T	Ť Ť Ť

Character	Accented Characters
u	ú ù û ü ů ū ů
U	Ú Ù Û Ü Ů Ū Ů
y	ý ÿ
Y	Ý Ÿ
z	ž ź ž
Z	Ž Ž Ž



### Related Information

- [Enter Accented Characters](#)



## Set Character Attributes

You can set character attributes by label or per line.

- [Apply Character Attributes to a Character](#)
- [Apply Character Attributes to a Line of Text](#)
- [Attribute Setting Options](#)
- [Set Auto Fit Style](#)

## Apply Character Attributes to a Character

When formatting your text, you can preview your character attribute selections on the LCD.

1. Type the text you want.
2. Press .
3. Press ▲ or ▼ to select an attribute, and then press **OK**.
4. Press ▲ or ▼ to set a value for that attribute, and then press **OK**.
5. Press  to return to the text entry screen.



### Related Information



- [Set Character Attributes](#)

#### Related Topics:

- [Attribute Setting Options](#)

## Apply Character Attributes to a Line of Text

If you add multiple lines in your label, you can format each line of text to look different.

1. Type the lines of characters or text you want on your label.
2. Press ▲ or ▼ to move the cursor to the line whose character attributes you want to change.
3. Press  and  to display the available formatting attributes.

Three black lines (1) on the left side of the character attribute indicate that you are now applying the attribute to that specific line only.

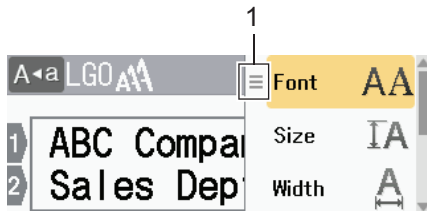

4. Press ▲ or ▼ to select an attribute, and then press **OK**.
5. Press ▲ or ▼ to set a value for that attribute, and then press **OK**.
6. Press  to return to the text entry screen.



When different attribute values are set for each line, each line's values appear as three black lines (1), also called a 'hamburger menu', when you press .

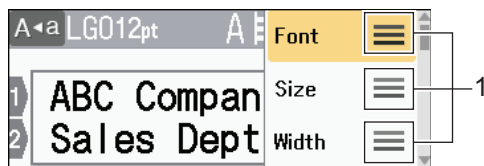

### ✓ Related Information

- [Set Character Attributes](#)

#### Related Topics:

- [Attribute Setting Options](#)

## Attribute Setting Options

### Font

Value	LCD Message	Result
Helsinki	HEL	A1
Dortmund	DTM	A1
Brussels	BRU	A1
Cooperstown	COP	A1
Atlanta	ATL	A1
US	US	A1
Los Angeles	LA	<b>A1</b>
San Diego	SGO	<b>A1</b>
Florida	FLO	<b>A1</b>
Calgary	CAL	<i>A1</i>
Belgium	BEL	A1
Adams	ADM	A1
Brunei	BRN	<b>A1</b>
Sofia	SOF	<b>A1</b>
Germany	GER	<i>A1</i>
Letter Gothic	LGO	A1
Istanbul	IST	<b>A1</b>

### Font Size

#### Available Sizes:

Auto, 6 pt, 9 pt, 12 pt, 18 pt, 24 pt, 36 pt, 42 pt, 48 pt



When Auto is selected, the text is automatically adjusted to print in the largest size available in the font settings for each tape width.

### Width

Value	Result
x 1	A
x 3/2	A
x 2	A



Value	Result
x 1/2	A
x 2/3	A

## Font Style

Value	LCD Message	Result
Normal	Normal	A
Bold	BLD	<b>A</b>
Underline	UND	<u>A</u>
Underline Bold	UND+BLD	<b><u>A</u></b>
Strikeout	STR	<del>A</del>
Outline	OUT	A
Shadow	SHD	A
Solid	SLD	A
Italic	ITA	<i>A</i>
Italic Bold	I+BLD	<b><i>A</i></b>
Underline + Italic	UND+ITA	<u><i>A</i></u>
Underline + Bold + Italic	UND+BLD+ITA	<b><u><i>A</i></u></b>
Italic Outline	I+OUT	<i>A</i>
Italic Shadow	I+SHD	<i>A</i>
Italic Solid	I+SLD	<i>A</i>
Vertical	VERT	A
Vertical Bold	VERT+BLD	<b>A</b>

## Alignment

Value	Result
Left	ABC
Centre	ABC
Right	ABC
Justify	A B C



### Related Information

- [Set Character Attributes](#)

## Set Auto Fit Style

You can reduce the text size to fit within the length of your label.

1. Press .
2. Press ◀ or ▶ to display [Settings], and then press **OK**.
3. Press ▲ or ▼ to display [Auto Fit Style], and then press **OK**.
4. Press ▲ or ▼ to select one of following options:

Option	Description
Text Size	The total text size is reduced to fit within the label.
Text Width	The text width is reduced to the size of the x 1/2 or x 2/3 setting to fit within the label. For the expected output, see <i>Related Topics</i> .

5. Press **OK**.



### Related Information



- [Set Character Attributes](#)

#### Related Topics:

- [Attribute Setting Options](#)

## Set Label Length

Labels can be between 30 mm and 300 mm in length. When you select `[Auto]`, the label length is automatically adjusted based on the amount of text entered.

1. Press .
2. Press **▲** or **▼** to display `[Length]`, and then press **OK**.
3. Do one of the following:
  - Press **▲** or **▼** to set a value, and then press **OK**.
  - Set the label length by typing in the length you want using the number keys. When finished, press **OK**.
4. Press  to return to the text entry screen.



### Related Information

- [Edit a Label](#)
  - [Set Frames](#)

#### Related Topics:

- [Change the Tab Length](#)
- [Select a Cut Option](#)

## Set Frames

1. Press .
2. Press ▲ or ▼ to display [Frame], and then press **OK**.
3. Press ▲ or ▼ to select a category, and then press **OK**.
4. Press ▲, ▼, ◀, or ▶ to select a frame, and then press **OK**.



You can also select a frame by entering its number. For more information, see *Related Information*.



### Related Information

- [Set Label Length](#)
- [Frame Options](#)

## Frame Options

Category	Frames
Simple 1	
Simple 2	
Decorative	
Business 1	



## Use Auto Format Layouts

- [Use Templates](#)
- [Template Options](#)

## Use Templates

Select a layout from the preloaded templates included with your Label Printer, enter your text, and then apply any formatting you want. For preloaded templates, see *Related Topics: Template Options*.



If the width of the current Tape Cassette does not match the set width for the selected template, an error message appears when you try to print the label. Press **Esc** or any other key to clear the error message, and then insert the correct Tape Cassette or choose a different template.

**Example - To customise and print the preloaded template named Asset Tag 1:**



1. Press **Home**.
2. Press **Left** or **Right** to display [Auto Format], and then press **OK**.
3. Press **Up** or **Down** to display [Templates], and then press **OK**.
4. Press **Up** or **Down** to display [Asset Management], and then press **OK**.
5. Press **Up** or **Down** to display [Asset Tag 1], and then press **OK**.
6. Enter the text you want, and then press **OK**.
7. Enter the text for the next field, and then press **OK**.
8. Press **Up**, **Down**, **Left**, or **Right** to select a barcode attribute, and then press **OK**.
9. Enter the barcode data, and then press **OK**. For more information, see *Related Topics: Create a Barcode Label*.
10. Do one of the following:
  - Select [Print], and then press **OK**.
  - Press **Up** or **Down** to select one of the following options:

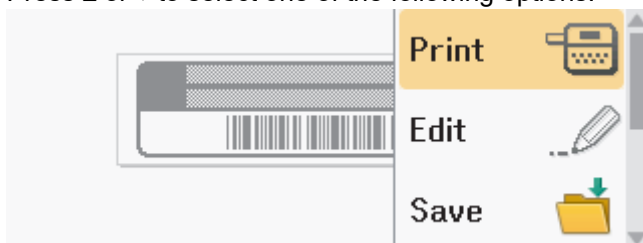

Option	Description
Edit	Change the text.
Save	Save the label. For more information, see <i>Related Topics: Use the File Memory</i> .
Menu	Change the Font or Style settings.
Preview	Preview the label before printing. Press <b>Magnify</b> to change the LCD magnification.
Print Options	Select print options. For more information, see <i>Related Topics: Print Labels</i> .

11. Press **Up** or **Down** to select the number of labels you want to print, and then press **Print** or **OK**.





---















## Related Information



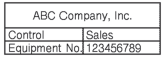





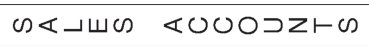

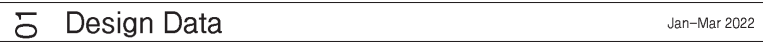



- [Use Auto Format Layouts](#)





### **Related Topics:**

- [Create a Barcode Label](#)
  - [Use the File Memory](#)
  - [Print Labels](#)
  - [Template Options](#)
-

## Template Options

Category	Value	Details
Asset Management	Asset Tag 1	 (24 mm x 70 mm)
	Asset Tag 2	 (18 mm x 70 mm)
	Asset Tag 3	 (24 mm x 70 mm)
	Asset Tag 4	 (18 mm x 70 mm)
	Asset Tag 5	 (24 mm x 70 mm)
	Asset Tag 6	 (18 mm x 70 mm)
	Asset Tag 7	 (12 mm x 70 mm)
	Bin Box	 (24 mm x 76 mm)
	Equipment Label	 (24 mm x 58 mm)
Cabinet	Cabinet Label 1	 (24 mm x 126 mm)
	Cabinet Label 2	 (18 mm x 111 mm)
	Cabinet Label 3	 (24 mm x 126 mm)
	Cabinet Label 4	 (24 mm x 160 mm)
File	Binder Spine 1	 (24 mm x 219 mm)
	Binder Spine 2	 (18 mm x 219 mm)

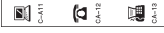
Category	Value	Details
	Binder Spine 3	 <p style="text-align: right;">Jan-Mar 2022</p> <p style="text-align: center;">(24 mm x 219 mm)</p>
	Binder Spine 4	 <p style="text-align: right;">Jan-Mar 2022</p> <p style="text-align: center;">(12 mm x 219 mm)</p>
	File Folder Tab	 <p style="text-align: center;">(12 mm x 82 mm)</p>
	Divider Tab	 <p style="text-align: center;">(12 mm x 42 mm)</p>
	Document index	 <p style="text-align: center;">(24 mm x 36 mm)</p>
Address/ID	Address Label 1	 <p style="text-align: center;">(24 mm x 72 mm)</p>
	Address Label 2	 <p style="text-align: center;">(24 mm x 72 mm)</p>
	Name Badge 1	 <p style="text-align: center;">(24 mm x 72 mm)</p>
	Name Badge 2	 <p style="text-align: center;">(24 mm x 72 mm)</p>
	Name Badge 3	 <p style="text-align: center;">(18 mm x 72 mm)</p>
	Name Badge 4	 <p style="text-align: center;">(24 mm x 72 mm)</p>
	Media	SD Card Label
USB Flash Memory		 <p style="text-align: center;">(9 mm x 25 mm)</p>
DVD Case Spine		 <p style="text-align: center;">(9 mm x 178mm)</p>
CD Case Spine		 <p style="text-align: center;">(6 mm x 113 mm)</p>
Cable Labelling	Flag 1	 <p style="text-align: center;">(12 mm x 90 mm)</p>
	Flag 2	 <p style="text-align: center;">(12 mm x 90 mm)</p>

Category	Value	Details
	Cable Wrap 1	 (24 mm x 39 mm)
	Cable Wrap 2	 (18 mm x 39 mm)
	Faceplate (VRT)	 (12 mm x 70 mm)
Signage	Signage 1	 (24 mm x 66 mm)
	Signage 2	 (24 mm x 50 mm)



## Related Information

- [Use Auto Format Layouts](#)

## Use Block Layouts

You can choose different Block Layouts, based on the tape size, to arrange text lines on your label. Select one of the Block Layout options, enter your text, and then apply text formatting if needed. To see what options are available for the tape you are using, see *Related Information: Block Layout Options*.

1. Press .
2. Press ◀ or ▶ to display [Auto Format], and then press **OK**.
3. Press ▲ or ▼ to display [Block Layouts], and then press **OK**.
4. Press ▲ or ▼ to select the tape width you want, and then press **OK**.
5. Press ▲ or ▼ to select the block layout you want, and then press **OK**.
6. Enter the text you want, and then press **OK**.
7. Repeat these steps for each text field, and then press **OK**.
8. Press **OK** to display the print menu.
9. Do one of the following:
  - Select [Print], and then press **OK**.
  - Press ▲ or ▼ to select one of the following options:

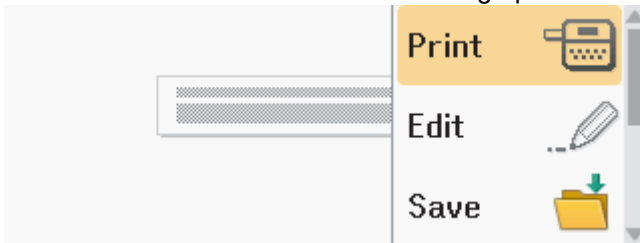

Option	Description
Edit	Change the text.
Save	Save the label. For more information, see <i>Related Topics: Use the File Memory</i> .
Menu	Change the Font, Align, or Frame settings.
Preview	Preview the label before printing. Press  to change the magnification of the LCD.
Print Options	Select print options. For more information, see <i>Related Topics: Print Labels</i> .

10. Press ▲ or ▼ to select the number of labels you want to print, and then press  or **OK**.



If the width of the current Tape Cassette does not match the set width for the selected layout, an error message appears when you try to print the label. Press  or any other key to clear the error message, and then insert the correct Tape Cassette.



### Related Information

- [Edit a Label](#)
  - [Block Layout Options](#)







---



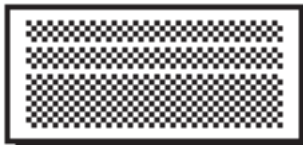
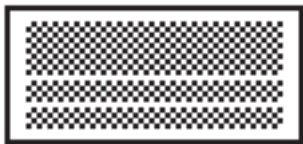
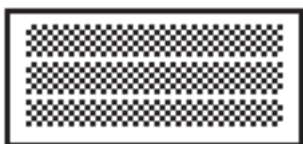

**Related Topics:**

- [Use the File Memory](#)
  - [Print Labels](#)
-

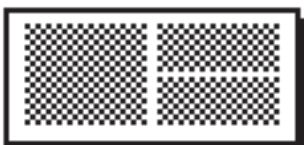

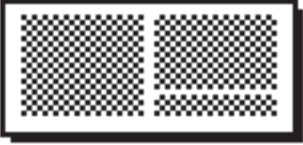
## Block Layout Options

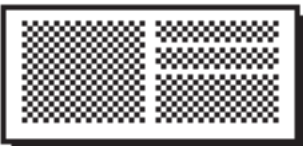
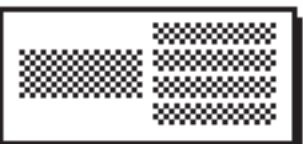
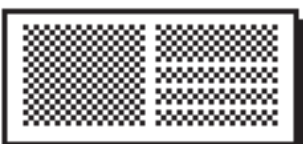
### 24 mm Tape





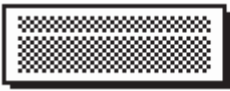
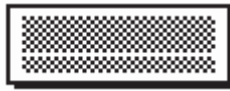
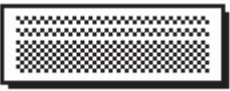



Value	Details
1Line(Inversion)	 ... 48pt
2LineA	 ... 12pt ... 36pt
2LineB	 ... 36pt ... 12pt
3LineA	 ... 12pt ... 12pt ... 24pt
3LineB	 ... 24pt ... 12pt ... 12pt
3LineC	 ... 18pt ... 18pt ... 12pt
1+1LineA	24pt...  ... 48pt
1+1LineB	36pt...  ... 18pt
1+1LineC	48pt...  ... 24pt
1+2LineA	48pt...  ... 24pt ... 24pt

Value	Details
1+2LineB	48pt...  ... 12pt ... 36pt
1+2LineC	48pt...  ... 36pt ... 12pt
1+3LineA	48pt...  ... 12pt ... 12pt ... 12pt
1+3LineB	48pt...  ... 24pt ... 12pt ... 12pt
1+3LineC	48pt...  ... 12pt ... 12pt ... 24pt
1+4LineA	24pt...  } ... 12pt
1+4LineB	48pt...  ... 18pt } ... 9pt
1+5Line	24pt...  } ... 9pt





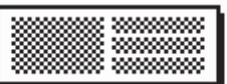

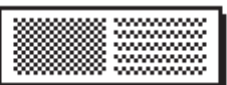
## 18 mm Tape

Value	Details
2LineA	 ... 12pt ... 24pt
2LineB	 ... 24pt ... 12pt
3LineA	 ..... 9pt ..... 9pt ... 24pt
3LineB	 ... 24pt ..... 9pt ..... 9pt





Value	Details
1+1LineB	36 pt...  ... 18 pt
1+1LineC	42 pt...  ... 18 pt
1+2LineA	42 pt...  ... 18 pt ... 18 pt
1+2LineB	42 pt...  ... 12 pt ... 24 pt
1+2LineC	42 pt...  ... 24 pt ... 12 pt
1+2LineD	42 pt...  ... 18 pt ... 18 pt
1+3Line	42 pt...  } ... 12 pt
1+4Line	24 pt...  } ... 9 pt
1+5Line	24 pt...  } ... 9 pt

## 12 mm Tape

Value	Details
2LineA	 ..... 9 pt ... 12 pt
2LineB	 ... 12 pt ..... 9 pt
3LineA	 ..... 6 pt ..... 6 pt ..... 12 pt
3LineB	 ... 12 pt ..... 6 pt ..... 6 pt
1+1LineA	12 pt...  ... 24 pt
1+1LineB	18 pt...  ..... 9 pt
1+1LineC	24 pt...  ... 12 pt

Value	Details
1+2Line	24pt...  ... 12pt ... 12pt

## 9 mm Tape

Value	Details
2LineA	 ..... 6pt ..... 12pt
2LineB	 ... 12pt ..... 6pt
1+2Line	18pt...  ..... 9pt ..... 9pt

## 6 mm Tape

Value	Details
1+2Line	12pt...  ..... 6pt ..... 6pt



### Related Information

- [Use Block Layouts](#)

## Create Tables

Create a table by setting the number of rows and columns you want. You can save the file as a template to reuse in other labels.



There is a maximum number of rows, depending on the tape width.

Max Lines	Tape Width
7 lines	24 mm
5 lines	18 mm
3 lines	12 mm
2 lines	9 mm 6 mm

1. Press .
2. Press ◀ or ▶ to display [Auto Format], and then press **OK**.
3. Press ▲ or ▼ to display [Table Format], and then press **OK**.  
Use the ▲, ▼, ◀, and ▶ keys to create your table.
4. Press ▲ or ▼ to select the tape width you want, and then press **OK**.
5. Press ▲ or ▼ to select [Rows].
6. Press ◀ or ▶ to set the number of rows you want.
7. Press ▲ or ▼ to select [Columns].
8. Press ◀ or ▶ to set the number of columns you want, and then press **OK**.
9. Enter the text you want, and then press **OK**.
10. Repeat these steps for each text field, and then press **OK**.
11. Do one of the following:
  - Select [Print], and then press **OK**.
  - Press ▲ or ▼ to select one of the following options:

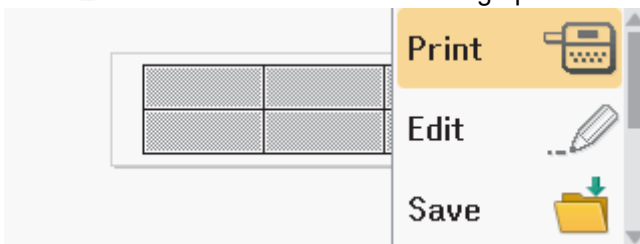

Option	Description
Edit	Change the text.
Save	Save the label. For more information, see <i>Related Topics: Use the File Memory</i> .
Menu	Change the Font or Style settings.
Preview	Preview the label before printing. Press  to change the LCD magnification.
Print Options	Select print options. For more information, see <i>Related Topics: Print Labels</i> .

---

12. Press ▲ or ▼ to select the number of labels you want to print, and then press  or **OK**.



- 3.5 mm tape cannot be used to create tables.
- If the width of the current Tape Cassette does not match the set width for the selected layout, an error message appears when you try to print the label. Press  or any other key to clear the error message, and then insert the correct Tape Cassette.



### Related Information

- [Edit a Label](#)

#### Related Topics:

- [Use the File Memory](#)
  - [Print Labels](#)
  - [Block Layout Options](#)
-

## **Create a Barcode Label**

- [Create and Print Barcodes](#)
- [Edit or Delete a Barcode and Barcode Data](#)

## Create and Print Barcodes



The Label Printer is not designed exclusively for creating barcode labels. Always check that barcode labels can be read by the barcode reader.

For best results, print barcode labels in black ink on white tape. Some barcode readers may not be able to read barcode labels created using coloured tape or ink.

Up to five barcodes can be printed on a label.

### NOTE

- Use the [Large] setting for [Width] whenever possible. Some barcode readers may not be able to read barcode labels created using the [Small] setting.
- Continuously printing a large number of labels with barcodes can overheat the Print Head, which may affect the print quality.
- Symbols are available only for the CODE39, CODE128, CODABAR, or GS1-128 protocols.
- The "C.Digit" (Check Digit) attribute is available only for the CODE39, I-2/5, and CODABAR protocols.

1. Press .
2. Press ▲ or ▼ to display [Barcode], and then press **OK**.
3. Press ▲, ▼, ◀, or ▶ to select an attribute, and then press **OK**.
4. Enter the barcode data. For more information, see *Related Topics*.
5. Press  or .
6. Press ▲ or ▼ to select a character, and then press **OK**.
7. Press **OK**.

### ✓ Related Information

- [Create a Barcode Label](#)
  - [Barcode Options](#)

## Barcode Options

Attribute	Value
Protocol	CODE39, CODE128, EAN-8, EAN-13, GS1-128 (UCC/EAN-128), UPC-A, UPC-E, I-2/5 (ITF), CODABAR
Width	Small
	Large
Under# (Characters printed below the barcode)	On
	Off
C.Digit (Check Digit)	Off
	On (Available only for the CODE39, I-2/5, and CODABAR protocols)

### Special Character Options

#### CODE39

Special Character
—
.
(SPACE)
\$
/
+
%

#### CODABAR

Special Character
—
\$
:
/
.

Special Character
+

### CODE128, GS1-128 (UCC / EAN-128)

Special Character			
(SPACE)	!	"	#
\$	%	&	'
(	)	*	+
,	-	.	/
:	;	<	=
>	?	@	[
\	]	^	_
NUL	·	SOH	STX
ETX	EOT	ENQ	ACK
BEL	BS	HT	LF
VT	FF	CR	SO
SI	DLE	DC1	DC2
DC3	DC4	NAK	SYN
ETB	CAN	EM	SUB
ESC	{	FS	
GS	}	RS	~
US	DEL	FNC3	FNC2
FNC4	FNC1		



#### Related Information

- [Create and Print Barcodes](#)



## Edit or Delete a Barcode and Barcode Data

>> [Delete a barcode from a label](#)

>> [Edit Barcode Data](#)

### Delete a barcode from a label

1. Position the cursor to the right of the barcode on the data entry screen.
2. Press .

### Edit Barcode Data

#### PT-D610BT

1. To edit barcode attributes and barcode data, position the cursor to the left of the barcode on the data entry screen.
2. Press  to open the Barcode Setup screen.
3. Press **▲** or **▼** to display [Barcode], and then press **OK**.

### Related Information

- [Create a Barcode Label](#)

## Use the Time and Date Function

You can add time and date to your label.

- [Set the Time and Date](#)
- [Set the Time and Date Format](#)
- [Set the Timestamp and Add the Time and Date to a Label](#)
- [Change or Delete the Time and Date Settings](#)

## Set the Time and Date

Set the time and date in the Clock setting. After setting the time and date, you can add this information to your label using the Time and Date function.

1. Press .
2. Press ◀ or ▶ to display [Settings], and then press **OK**.
3. Press ▲ or ▼ to display [Set Clock], and then press **OK**.
4. Press ▲ or ▼ to set the year.
5. Press ◀ or ▶ to move to the next field.
6. Press ▲ or ▼ to update the field.
7. Press **OK**.

### NOTE

- You can also use the device's number keys to type the time and date.
- The time and the date are active as soon as you press **OK**.
- To back up the time and date settings even when your device is not plugged into a power source, install two AA alkaline batteries (LR6).



### Related Information

- [Use the Time and Date Function](#)

## Set the Time and Date Format

This Label Printer offers various time and date formats to add to your label. Choose either the analogue or digital style.

1. Press .
2. Press ◀ or ▶ to display [Settings], and then press **OK**.
3. Press ▲ or ▼ to display [Time & Date Format], and then press **OK**.
4. Press ▲ or ▼ to display [Date] or [Time].
5. Press ◀ or ▶ to set the format.
6. Press **OK**.



### Related Information

- [Use the Time and Date Function](#)
  - [Time and Date Format Options](#)

## Time and Date Format Options

Available time and date format options are listed in the table. You can set the time and date from the device's [Settings] > [Time & Date Format] menu.

Attribute	Format Options	Attribute	Format Options
Date	<b>12/31/2099</b>	Date	2099-12-31
	12.31.2099		31/12/2099
	12-31-2099		31.12.2099
	December 31, 2099		31-12-2099
	Dec. 31, 2099		31. December 2099
	2099/12/31		31. Dec. 2099
Time	<b>11:59 PM</b>	Time	23:59

The default settings are shown in Bold.

### NOTE

The values for the date and time are used to display a sample setting. When a format is selected, the time and date you set in the Clock setting will appear in the selected format option.



### Related Information

- [Set the Time and Date Format](#)





## Set the Timestamp and Add the Time and Date to a Label

1. Press .
2. Press ◀ or ▶ to display [Settings], and then press **OK**.
3. Press ▲ or ▼ to display [Time Stamp Setting], and then press **OK**.
4. Press ▲ or ▼ to select one of the following options:

- **[Timing]**

Use the [Time Stamp] to add the date and the time to any label.

- a. Press ▲ or ▼ to display [Timing].
- b. Press ◀ or ▶ to display [Auto] or [Fixed], and then press **OK**.

Option	Description
Auto	<ul style="list-style-type: none"> <li>• Position the cursor where you want the time and date to appear. Press , press ▲ or ▼ to select Time Stamp, and then press <b>OK</b>. The current date and time (or a future or past date and time, if you previously set them using the Forward option) and a clock icon appear on the LCD.</li> <li>• When you press  <b>only</b>, the latest date and time will print on the label. The clock icon does not print.</li> </ul>
Fixed	<ul style="list-style-type: none"> <li>• Position the cursor where you want the time and date to appear. Press , press ▲ or ▼ to select Time Stamp, and then press <b>OK</b>. The current date and time appear on the LCD.</li> <li>• When you press , the date and time will print on your label.</li> </ul>



Check and confirm the time and date settings by positioning the cursor to the left of the clock icon, pressing , pressing ▲ or ▼ to select [Time Stamp], and then pressing **OK**.

- **[Format]**

Select what time and date format you want to use.

- a. Press ▲ or ▼ to select [Format].
- b. Press ◀ or ▶ to select the format option you want.

Option	Description
Date	Prints only the date on the label.
D&T	Prints the date and time on the label.
Time	Prints only the time on the label.
T&D	Prints the time and date on the label.

- c. Press **OK**.

- **[Forward]**

Set a future or past date and time.

- a. Press ▲ or ▼ to select [Forward].
- b. Press ◀ or ▶ to select [On] and specify the date and time values you want to use, and then press **OK**.

Option	Description
On	Allows you to increase or decrease the time and date values.

---

Option	Description
Off	Prints the current time and date.

- c. Press ◀ or ▶ to select the year, month, week, date, hour or minute.
- d. Press ▲ or ▼ to change the current date and time as needed.



---

You can also set the date and time by entering the numbers using the keyboard.

---

- e. Press **OK**.



### Related Information

- [Use the Time and Date Function](#)
-

## Change or Delete the Time and Date Settings

>> [Change Time and Date Settings](#)

>> [Delete the Time and Date from a Label](#)

### Change Time and Date Settings

1. Position the cursor to the left of the clock icon on the text entry screen.
2. Press  to open the time stamp setting screen.
3. Update the settings you want and press **OK** when finished.

### Delete the Time and Date from a Label

1. Position the cursor to the right of the clock icon on the text entry screen.
2. Press .



### Related Information

- [Use the Time and Date Function](#)













## Print Labels

- [Preview Labels](#)
- [Print Labels](#)
- [Select a Cut Option](#)
- [Adjust the Label Length](#)
- [Print Transferred Templates](#)

## Preview Labels

You can preview labels before printing to make sure they are correct.

1. Press .
2. Do one of the following:
  - Press , , , or  to scroll the preview left, right, up, or down.
  - Press  and , , , or  to scroll directly to the left, right, top, or bottom border.
  - Press  to change the preview magnification.

### Related Information

- [Print Labels](#)
-

## Print Labels

### NOTE

- Do not pull the label when the Label Printer is ejecting it from the Tape Exit Slot. Doing so will cause the ink ribbon to be discharged with the tape, making the tape unusable.
- Do not block the Tape Exit Slot during printing. Doing so will cause the tape to jam.

1. After creating your label, press .
2. Press ▲ or ▼ to change the number of copies, and then press  or **OK**.



- You can also specify the number of copies using the number keys.
- If you need only one copy of the label, press  without selecting the number of copies.







### Related Information

- [Print Labels](#)
  - [Sequential Printing](#)
  - [Mirror Printing](#)

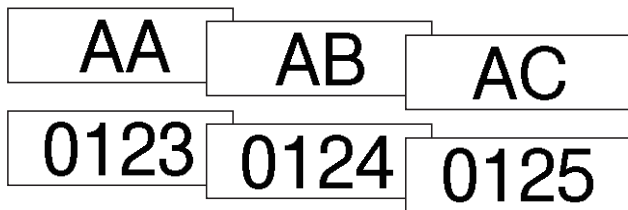
## Sequential Printing

Use this function to create labels with sequentially arranged numbers or letters, from a single label format.



1. Press  and .
2. Press ▲ or ▼ to display [Number], and then press **OK**.
3. Press ◀ or ▶ to select the start point, and then press **OK**.
4. Press ◀ or ▶ to select the end point, and then press **OK**.
5. Press ▲ or ▼ to select the number of labels you want to print, and then press  or **OK**.

### Related Information

- [Print Labels](#)

## Mirror Printing

Use clear tape in [Mirror], so the labels can be read correctly from the opposite side when attached to glass, windows, or other transparent surfaces.

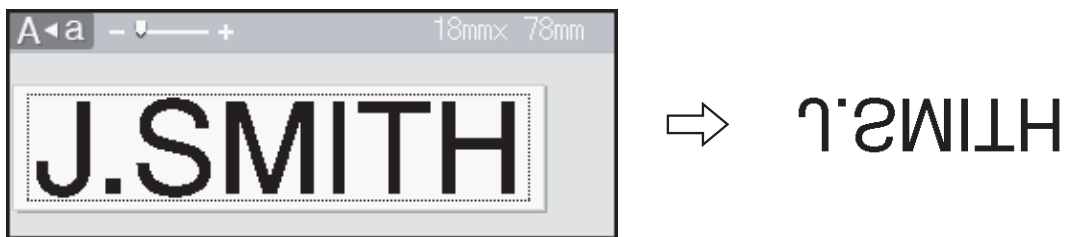

1. Press  and .
2. Press  or  to select [Mirror], and then press **OK**.
3. Press  or **OK**.

### ✓ Related Information

- [Print Labels](#)

## Select a Cut Option

Choose from several built-in options to determine how the Label Printer cuts your labels.

1. Press .
2. Press ▲ or ▼ to display [Cut Option], and then press **OK**.
3. Press ▲ or ▼ to select [Small Margin], [Large Margin], [Chain], [No Cut], or [Special Tape], and then press **OK**.







### Related Information



- [Print Labels](#)
  - [Tape Cutting Options](#)

## Tape Cutting Options

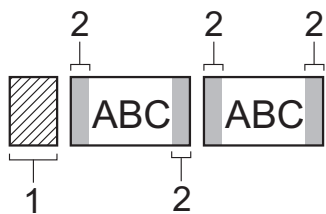
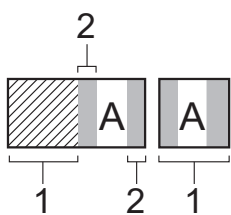
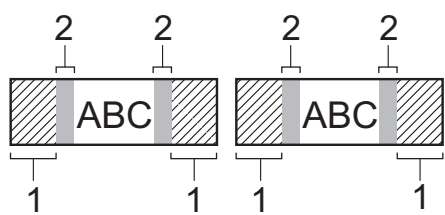
In the Options table, these visual patterns represent parts of your label, as illustrated in the Example column.

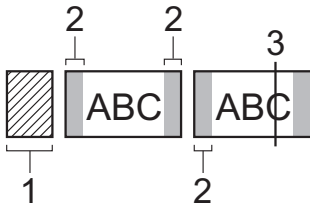
	Print area
	Margin
	Laminate margin

Setting	Description	Example
Small Margin	Automatically cuts a piece of blank tape before printing the first label and then cuts the tape after each label is printed, leaving a 2 mm margin at both ends of each label.	<ul style="list-style-type: none"> <li>When the label length is approximately 23 mm or more                             <div style="text-align: center; margin: 10px 0;">  </div> <ol style="list-style-type: none"> <li>Approximately 23 mm</li> <li>2 mm</li> </ol> </li> <li>When the label length is approximately 23 mm or less                             <div style="text-align: center; margin: 10px 0;">  </div> <ol style="list-style-type: none"> <li>Approximately 23 mm</li> <li>2 mm</li> </ol> </li> </ul>
Large Margin	Automatically cuts the tape after each label is printed, leaving a margin of 25 mm on each end.	<div style="text-align: center; margin: 10px 0;">  </div> <ol style="list-style-type: none"> <li>Approximately 23 mm</li> <li>2 mm</li> </ol>
Chain	<ul style="list-style-type: none"> <li>Automatically cuts a piece of blank tape before printing the first label and then cuts the tape after each label is printed, leaving a 2 mm margin at both ends of each label.</li> <li>When the last label is printed, the tape is neither fed nor cut. Press  and  simultaneously to feed and cut the tape.</li> </ul>	<div style="text-align: center; margin: 10px 0;">  </div> <ol style="list-style-type: none"> <li>Approximately 23 mm</li> <li>2 mm</li> <li>Cut Position</li> </ol>

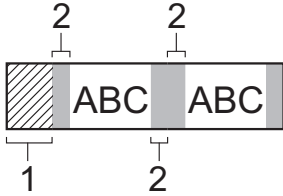
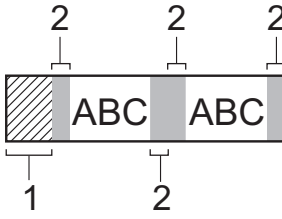
Setting	Description	Example
No Cut	<ul style="list-style-type: none"> <li>Select this setting when printing multiple copies of a label, or when using Fabric Iron-On Tapes or other special tapes that cannot be cut by the Tape Cutter of the Label Printer.</li> <li>When the last label is printed, the tape is not fed and cut.               <ul style="list-style-type: none"> <li>Press  and  simultaneously to feed and cut the tape.</li> <li>When using the special tapes that cannot be cut by the Tape Cutter of the Label Printer, remove the Tape Cassette from the Label Printer and use scissors to cut the tape.</li> </ul> </li> </ul>	 <ol style="list-style-type: none"> <li>23 mm</li> <li>2 mm</li> </ol>
Special Tape	Select this setting when using special tape.	 <ol style="list-style-type: none"> <li>Approximately 23 mm</li> <li>2 mm</li> </ol>



### Related Information

- Select a Cut Option



## Adjust the Label Length

When the Tape Cassette is almost empty, the printed label length may be less accurate. In this case, adjust the label length manually.



Approximately 1% of the total label length is adjusted by one level.

1. Press .
2. Press ◀ or ▶ to display [Settings], and then press **OK**.
3. Press ▲ or ▼ to display [Adjustment], and then press **OK**.
4. Press ▲ or ▼ to display [Label Length], and then press **OK**.
5. Press ◀ or ▶ to display [-3 - +3], and then press **OK**.



### Related Information

- [Print Labels](#)

## Print Transferred Templates

You can transfer templates created in P-touch Editor to the Label Printer.

1. Press .
2. Press ◀ or ▶ to display [Transferred Templates], and then press **OK**.
3. Press ▲ or ▼ to select the template you want to print, and then press **OK**.
4. Press ▲ or ▼ to display [Print], and then press **OK**.



If you have not yet transferred templates from P-touch Editor, [Transferred Templates] will not appear in the list of options.

For more information, see *Related Topics*.



### Related Information

- [Print Labels](#)
  - [Edit and Print Transferred Templates](#)
  - [Print Transferred Templates from the Database](#)
  - [Delete a Transferred Template](#)

#### Related Topics:

- [Transfer Templates to the Printer \(P-touch Transfer Manager\) \(Windows\)](#)

## Edit and Print Transferred Templates

1. Press .
2. Press ◀ or ▶ to display [Transferred Templates], and then press **OK**.
3. Press ▲ or ▼ to select the template you want to edit, and then press **OK**.
4. Press ▲ or ▼ to display [Edit Label without Saving], and then press **OK**.
5. Edit the template.



You cannot add or delete a line break when editing a transferred template.

6. Press ▲ or ▼ to select the edited template, and then press **OK**.
7. Press ▲ or ▼ to display [Print], and then press **OK**.



You cannot save your changes to a transferred template.



### Related Information

- [Print Transferred Templates](#)

## Print Transferred Templates from the Database

1. Press .
2. Press ◀ or ▶ to display [Transferred Templates], and then press **OK**.
3. Press ▲ or ▼ to select the template you want to print, and then press **OK**.
4. Press ▲ or ▼ to display [Print from Database], and then press **OK**.
5. Press ◀, ▶, ▲, or ▼ to select the first record in the range you want to print.
6. Press ◀, ▶, ▲, or ▼ to select the last record in the range you want to print.  
The records in the selected range are highlighted on the LCD.
7. Press ▲ or ▼ to display [Print], and then press **OK**.



The maximum number of characters that can be printed for one transferred template is 1500 characters. Line breaks and text blocks reduce the maximum number.



### Related Information

- [Print Transferred Templates](#)
  - [Find a Template in the Database](#)

## Find a Template in the Database

1. Press .
2. Press **◀** or **▶** to display [Transferred Templates], and then press **OK**.
3. Press **▲** or **▼** to select the template you want to print, and then press **OK**.



The first record of the selected database is displayed.

4. Type the data or name you want to find.

For example, type 'B' to find any character strings containing 'B'. Type 'BR' to find any character strings containing 'BR'.

Type as many letters or numbers as needed.



- If a string contains the character you typed, the cursor on the LCD moves to that content and highlights it. If the content doesn't exist, the cursor remains in its current position.
- If the character you searched for is contained in multiple fields in the database, press  and  simultaneously to move to the next field containing the character. The character is highlighted in the field.
- Press  to delete the last character in your search data. The cursor moves to the next field containing the remaining search characters.



### Related Information

- [Print Transferred Templates from the Database](#)

## Delete a Transferred Template

When you delete a transferred template, it is deleted only from your Label Printer.

1. Press .
2. Press ◀ or ▶ to display [Transferred Templates], and then press **OK**.
3. Press ▲ or ▼ to select the template you want to delete, and then press **OK**.
4. Press ▲ or ▼ to display [Delete], and then press **OK**.

The [Delete?] message appears.

5. Press **OK**.



### Related Information

- [Print Transferred Templates](#)

## Use the File Memory

- [Save Label Files](#)
- [Print, Open, Delete, or Mark a Saved Label](#)

## Save Label Files

You can save up to 99 labels and recall them for printing at a later date. A maximum of 280 characters can be saved per file. You can also edit and overwrite saved labels.

1. Enter the text and format your label.
2. Press .
3. Press ▲ or ▼ to display [Save], and then press **OK**.
4. Press ▲ or ▼ to select a file, and then press **OK**.





### Related Information

- [Use the File Memory](#)
-



## Print, Open, Delete, or Mark a Saved Label

1. Press .
2. Press ◀ or ▶ to display [File], and then press **OK**.
3. Press ▲ or ▼ to select a file, and then press **OK**.
4. Do one of the following:

Option	Description
Print	<ol style="list-style-type: none"><li>a. Press ▲ or ▼ to display <i>Print</i>, and then press <b>OK</b>.</li><li>b. Press ▲ or ▼ to change the number of copies, and then press  or <b>OK</b>.</li></ol>
Open	Press ▲ or ▼ to display <i>Open</i> , and then press <b>OK</b> .
Delete	<ol style="list-style-type: none"><li>a. Press ▲ or ▼ to display <i>Delete</i>, and then press <b>OK</b>.</li><li>b. Press <b>OK</b>. The <i>Delete?</i> message appears.</li><li>c. Press <b>OK</b>. To delete a saved label from the file selection screen, select the label using ▲ or ▼, and then press .</li></ol>
Marking	Saved files can be organised into eight different colour-coded categories. The colour choices appear on the left side of the file name in the file selection screen. <ol style="list-style-type: none"><li>a. Press ▲ or ▼ to display <i>Marking</i>, and then press <b>OK</b>.</li><li>b. Press ▲ or ▼ to select a colour, and then press <b>OK</b>.</li></ol>

### Related Information

- [Use the File Memory](#)

## Create and Print Labels Using Your Computer

- [Create Labels Using P-touch Editor \(Windows\)](#)
- [Create Labels and Print Using P-touch Editor \(Mac\)](#)
- [Print Labels Using the Printer Driver \(Windows\)](#)

## Create Labels Using P-touch Editor (Windows)

The transfer function can only be used with P-touch Editor 5.4.

To use your Label Printer with your Windows computer, install P-touch Editor and the printer driver on your computer.

For the latest drivers and software, go to your model's **Downloads** page on the Brother support website at [support.brother.com](http://support.brother.com).

1. Start P-touch Editor .

• **Windows 11:**

Click **Start > Brother P-touch > P-touch Editor**, or double-click the **P-touch Editor** icon on the desktop.

\*Depending on your computer's operating system, the Brother P-touch folder may or may not be created.

• **Windows 10:**

Click **Start > Brother P-touch > P-touch Editor**, or double-click the **P-touch Editor** icon on the desktop.

• **Windows 8.1:**

Click the **P-touch Editor** icon on the **Apps** screen, or double-click the **P-touch Editor** icon on the desktop.

2. Do one of the following:

• P-touch Editor 5.4

- To open an existing layout, click **Open** (1).
- To connect a preset layout to a database, select the checkbox next to **Connect Database** (2).
- To create a new layout, double-click the **New Layout** pane (3), or click the **New Layout** pane (3) and then click →.
- To create a new layout using a preset layout, double-click a category button (4), or select a category button (4), and then click →.

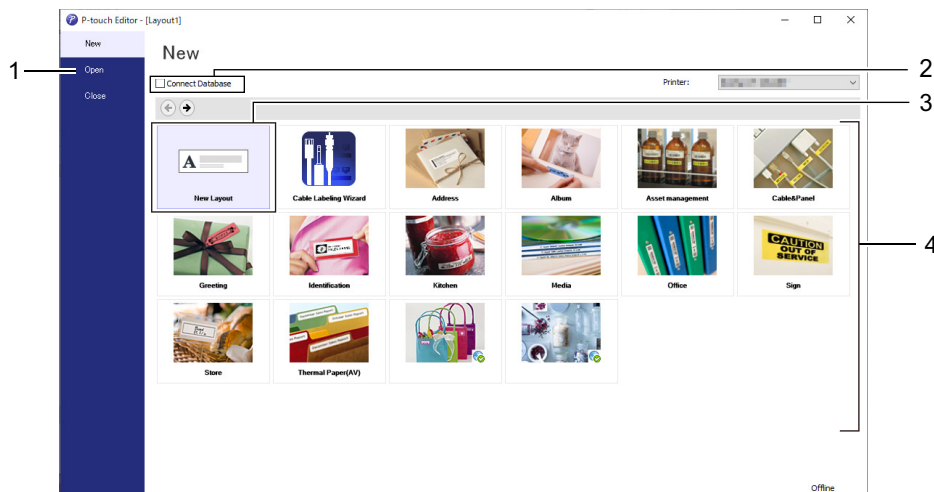

• P-touch Editor 6.0

- To open an existing layout, click **Open** (4).
- To create a new layout, click the **New Label** tab and the **New Label** button (1).
- To create a new layout using a preset layout, click the **New Label** tab and click a category button (2), select a template, and then click **Create** (3).

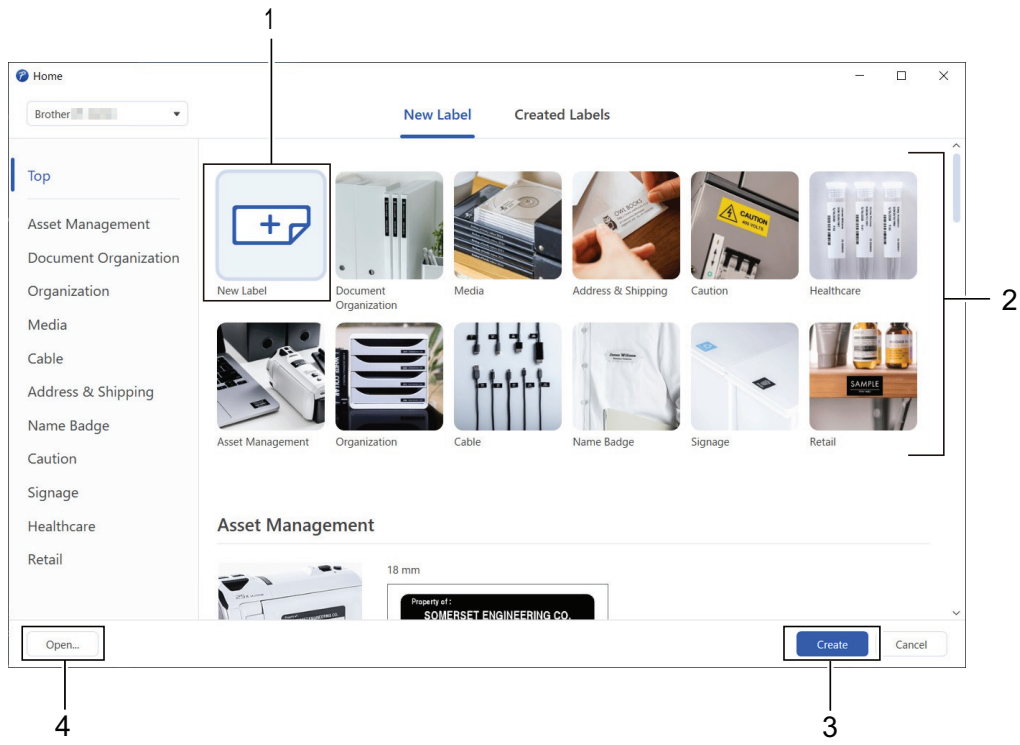

## Related Information

- [Create and Print Labels Using Your Computer](#)

## Create Labels and Print Using P-touch Editor (Mac)

Download and install P-touch Editor from the App Store on your Mac.

To use your Label Printer with your Mac computer, install P-touch Editor.

1. Double-click **Macintosh HD > Applications**, and then double-click the **Brother P-touch Editor** icon.
2. When P-touch Editor starts, click **New** to select a template, create a new layout, or open an existing layout.

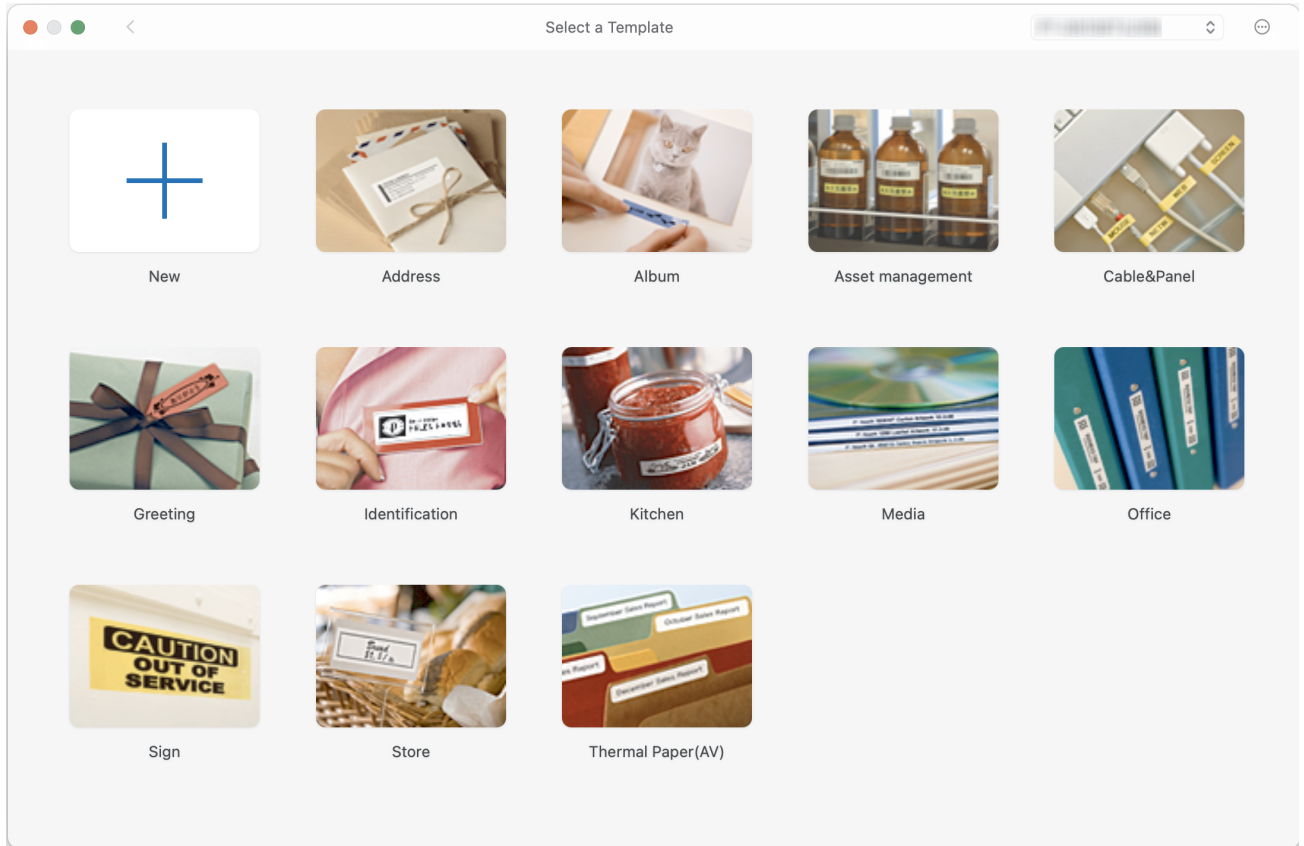

3. Select the print settings.
4. Click the **Print** icon.

### ✓ Related Information

- [Create and Print Labels Using Your Computer](#)
  - [Main Window of P-touch Editor \(Mac\)](#)

## Main Window of P-touch Editor (Mac)

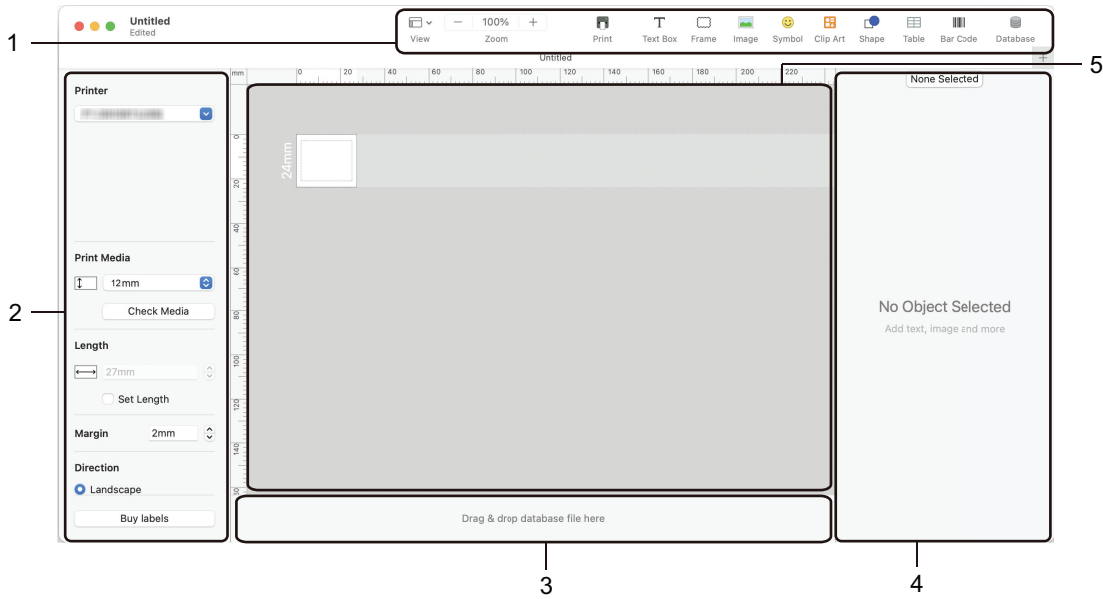

1. Toolbar
2. Object Inspector
3. Database Connection Area
4. Label Inspector
5. Layout Window

### ✓ Related Information

- [Create Labels and Print Using P-touch Editor \(Mac\)](#)

## Print Labels Using the Printer Driver (Windows)

Make sure you have installed the printer driver.

For the latest drivers and software, go to your model's **Downloads** page on the Brother support website at [support.brother.com](http://support.brother.com).

1. Connect the Label Printer to a computer.
2. Open the document you want to print.
3. Select the print command in your application.
4. Select your Label Printer, and then click the printer's properties or preferences button.  
The printer driver window appears.
5. Change the printer driver settings, if needed.
6. Click **OK**.
7. Complete your print operation.



### Related Information

- [Create and Print Labels Using Your Computer](#)

#### Related Topics:

- [Connect the Label Printer to a Computer Using a USB Cable](#)
- [Enable or Disable Bluetooth](#)
- [Install the Printer Driver and Software on a Computer \(Windows\)](#)

## Print Labels Using Mobile Devices

- [Install the Brother iPrint&Label App](#)
- [Create Labels and Print Using Mobile Devices](#)



## Install the Brother iPrint&Label App

Use Brother's iPrint&Label app to print directly from your iPhone, iPad, iPod touch, and Android™ mobile devices.

App	Features
Brother iPrint&Label	Create labels for business use, including barcodes, office equipment labels, and labels for folder tabs.

For more information about the mobile apps available for your printer, visit <https://support.brother.com/g/d/f5f9>.



### Related Information

- [Print Labels Using Mobile Devices](#)

## Create Labels and Print Using Mobile Devices

Make sure the Label Printer is connected to your mobile device via Bluetooth or using a USB cable.

1. Start the label printing app on your mobile device.
2. Select a label template or design.



You can also select a previously designed label or image and print it.

3. Select the print menu in the label printing app.



### Related Information

- [Print Labels Using Mobile Devices](#)

## **Transfer Templates to the Printer (P-touch Transfer Manager) (Windows)**

- [Transfer Templates to the Printer Using P-touch Transfer Manager \(Windows\)](#)
- [Distribute Templates to be Transferred to Users Without Using P-touch Transfer Manager \(Windows\)](#)

## **Transfer Templates to the Printer Using P-touch Transfer Manager (Windows)**

- [Notes on Using P-touch Transfer Manager \(Windows\)](#)
- [About Transferring Templates from the Computer to the Printer \(Windows\)](#)
- [Back up Templates or Other Data Saved in the Printer \(Windows\)](#)
- [Delete Printer Data \(Windows\)](#)
- [Create Transfer Files and Transfer Package Files \(Windows\)](#)

## Notes on Using P-touch Transfer Manager (Windows)

Some P-touch Editor functions are not available with the printer, so keep the following points in mind when using P-touch Editor to create templates.

You can preview created templates before they are transferred to the printer.

### Creating Templates

- Some of the text in the templates transferred to the printer may be printed using similar fonts and character sizes loaded in the printer. As a result, the printed label may differ from the image of the template created in P-touch Editor.
- Depending on the text object setting, the character size may be automatically reduced or some of the text may not be printed. If this occurs, change the Text Object setting.
- Although character styles can be applied to individual characters in P-touch Editor, styles can be applied to a block of text only from the printer. In addition, some character styles are not available on the printer.
- Backgrounds specified in P-touch Editor are not compatible with the printer.
- The P-touch Editor layout using the split printing function (enlarging the label and printing it on two or more labels) cannot be transferred.
- Only the portion of the label within the printable area is printed.

### Transferring Templates

- The printed label may differ from the image appearing in the preview area of P-touch Transfer Manager.
- If a two-dimensional barcode other than a QR code not loaded on the printer is transferred to the printer, the barcode is converted into an image. The image of the converted barcode cannot be edited.
- All transferred objects that cannot be edited by the printer are converted into images.
- Grouped objects are converted into a single bitmap.
- If objects overlap, only the bottom object is printed.

### Transferring Data Other Than Templates

If the number or order of fields in a database is changed and only the database (CSV file) is transferred to update it, the database may not link correctly with the template. In addition, the first line of data in the transferred file must be recognised by the printer as "field names".



#### Related Information

- [Transfer Templates to the Printer Using P-touch Transfer Manager \(Windows\)](#)

---

Home > [Transfer Templates to the Printer \(P-touch Transfer Manager\) \(Windows\)](#) > [Transfer Templates to the Printer Using P-touch Transfer Manager \(Windows\)](#) > [About Transferring Templates from the Computer to the Printer \(Windows\)](#)

## About Transferring Templates from the Computer to the Printer (Windows)

You can transfer templates and other data to the printer and save backups of your data on the computer.

To use P-touch Transfer Manager, you must first transfer templates created in P-touch Editor to P-touch Transfer Manager.

### Related Information

- [Transfer Templates to the Printer Using P-touch Transfer Manager \(Windows\)](#)
    - [Transfer a Template to P-touch Transfer Manager \(Windows\)](#)
    - [Main Window of P-touch Transfer Manager \(Windows\)](#)
    - [Transfer Templates or Other Data from the Computer to the Printer \(Windows\)](#)
-

## Transfer a Template to P-touch Transfer Manager (Windows)

1. Start P-touch Editor .
  - **Windows 11:**  
Click **Start > Brother P-touch > P-touch Editor**, or double-click the **P-touch Editor** icon on the desktop.  
\*Depending on your computer's operating system, the Brother P-touch folder may or may not be created.
  - **Windows 10:**  
Click **Start > Brother P-touch > P-touch Editor**, or double-click the **P-touch Editor** icon on the desktop.
  - **Windows 8.1:**  
Click the **P-touch Editor** icon on the **Apps** screen, or double-click the **P-touch Editor** icon on the desktop.
2. Open the template you want or create a layout.
3. Click **File > Transfer Template > Transfer**.

The P-touch Transfer Manager window appears. The template is transferred to the **Configurations** folder.

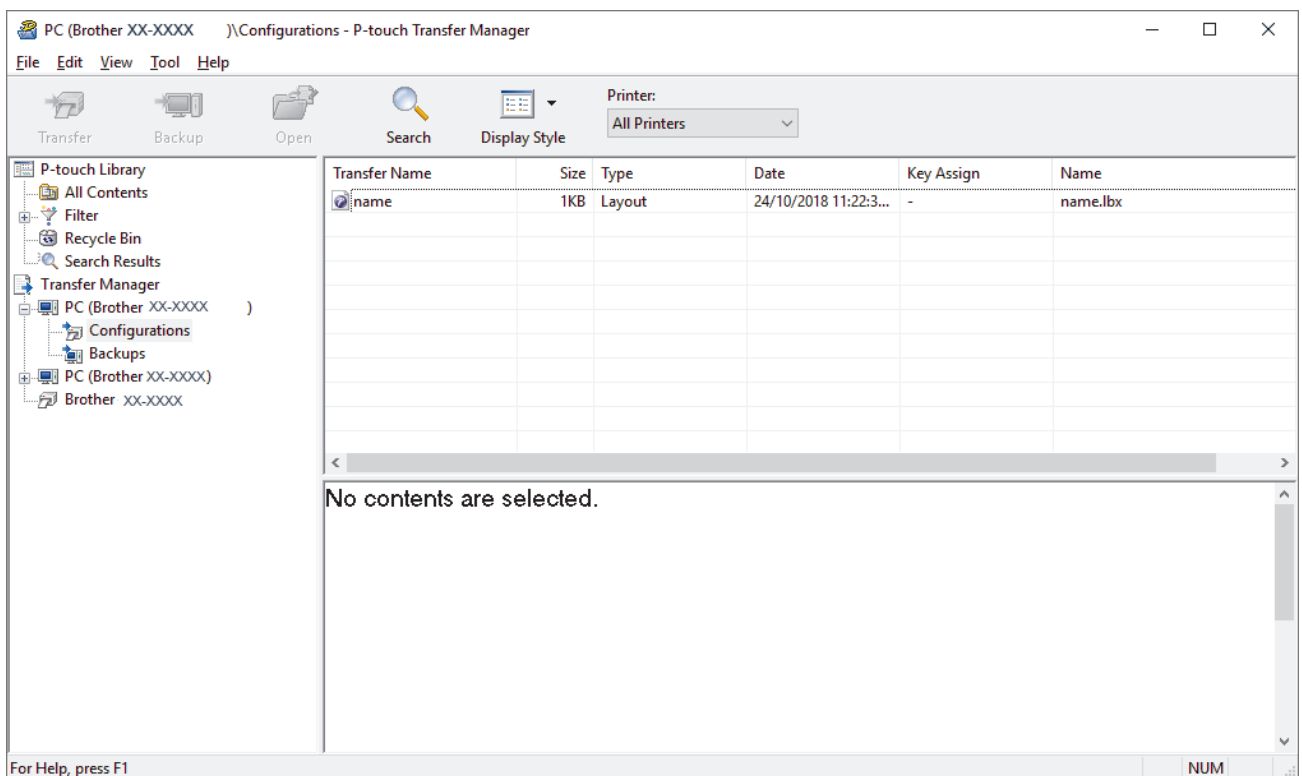

### ✓ Related Information

- [About Transferring Templates from the Computer to the Printer \(Windows\)](#)

## Main Window of P-touch Transfer Manager (Windows)

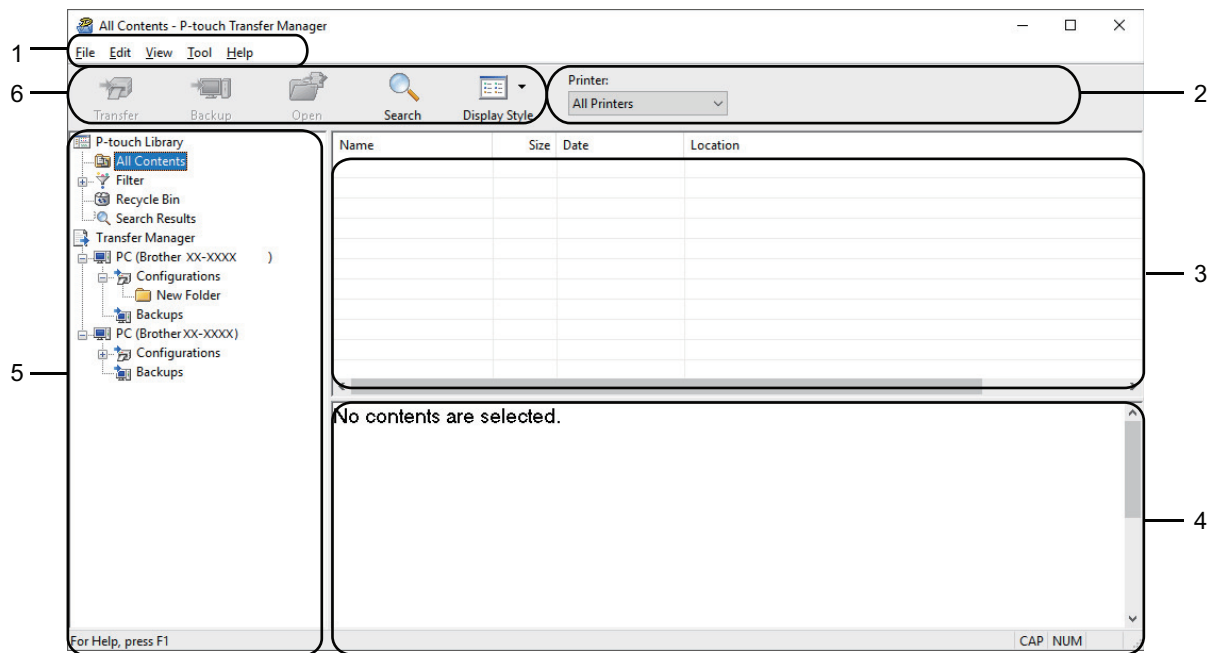

### 1. Menu Bar

Provides access to various commands grouped under each menu title (the **File**, **Edit**, **View**, **Tool**, and **Help** menus) according to their functions.

### 2. Printer Selector

Allows you to select a printer to transfer the data to. When you select a printer, only the data that can be sent to the selected printer appears in the data list.

### 3. Template List

Displays a list of templates in the selected folder.

### 4. Preview

Displays a preview of the templates in the templates list.





### 5. Folder List

Displays a list of folders and printers. When you select a folder, the templates in the selected folder appear in the template list. If you select a printer, the current templates and other data stored in the printer appear.

### 6. Toolbar

Provides access to frequently used commands.

## Toolbar Icons

Icon	Button name	Function
	<b>Transfer</b>	Click to transfer templates and other data from the computer to the printer.
	<b>Save Transfer File</b> (When not connected to a printer)	Click to change the file type of the data to be transferred to other applications. The available interfaces may differ depending on your model.
	<b>Backup</b>	Click to retrieve the templates and other data saved in the printer and saves it on the computer.
	<b>Open</b>	Click to open the selected template.
	<b>Search</b>	Click to search for templates or other data registered to P-touch Library.



---

Icon	Button name	Function
	Display Style	Click to change the file display style.



### Related Information

- [About Transferring Templates from the Computer to the Printer \(Windows\)](#)
-

## Transfer Templates or Other Data from the Computer to the Printer (Windows)



To transfer templates from a mobile device to the printer, see *Related Information*.

1. Connect the printer to the computer using a USB cable, and then turn the printer on.  
The printer model name appears next to a printer icon in the folder view.  
If you select the printer in the folder view, the current templates and other data stored in the printer appear.



If a printer is disconnected or offline, it does not appear in the folder view.

2. Select the printer you want to transfer the template or other data to.

Transfer Name	Size	Layout	Time	Key Assign	Name
name	1KB	Layout	24/10/2018 11:22:32 AM	-	name.lbx
CD	1KB	Layout	24/10/2018 3:13:35 PM	-	CD.lbx
address	1KB	Layout	24/10/2018 3:15:15 PM	-	address.lbx

3. Right-click the **Configurations** folder, select **New**, and then create a new folder.

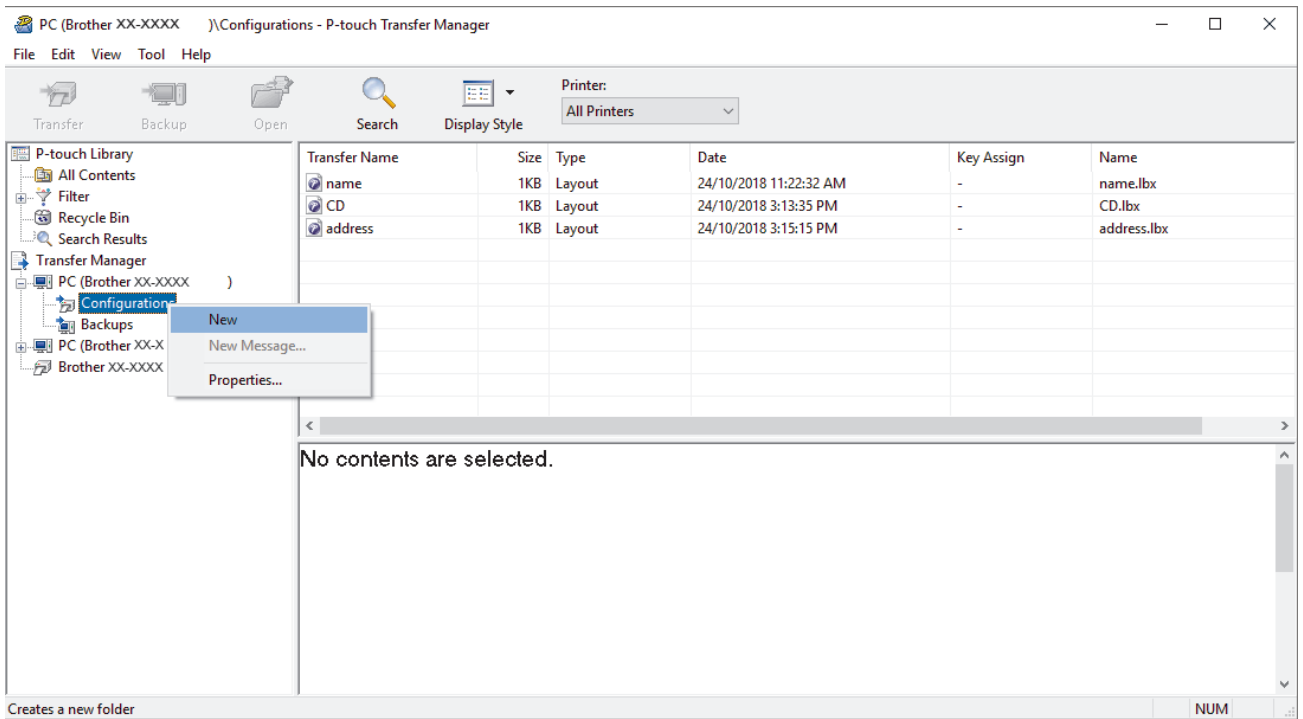

4. Do one of the following:

- Drag the template or other data you want to transfer and place it in the new folder.
- To transfer multiple templates or other data, drag the files you want to transfer, and then place them in the new folder. Each file is assigned a Key Assign number (memory location in the printer) when it is placed in the new folder.

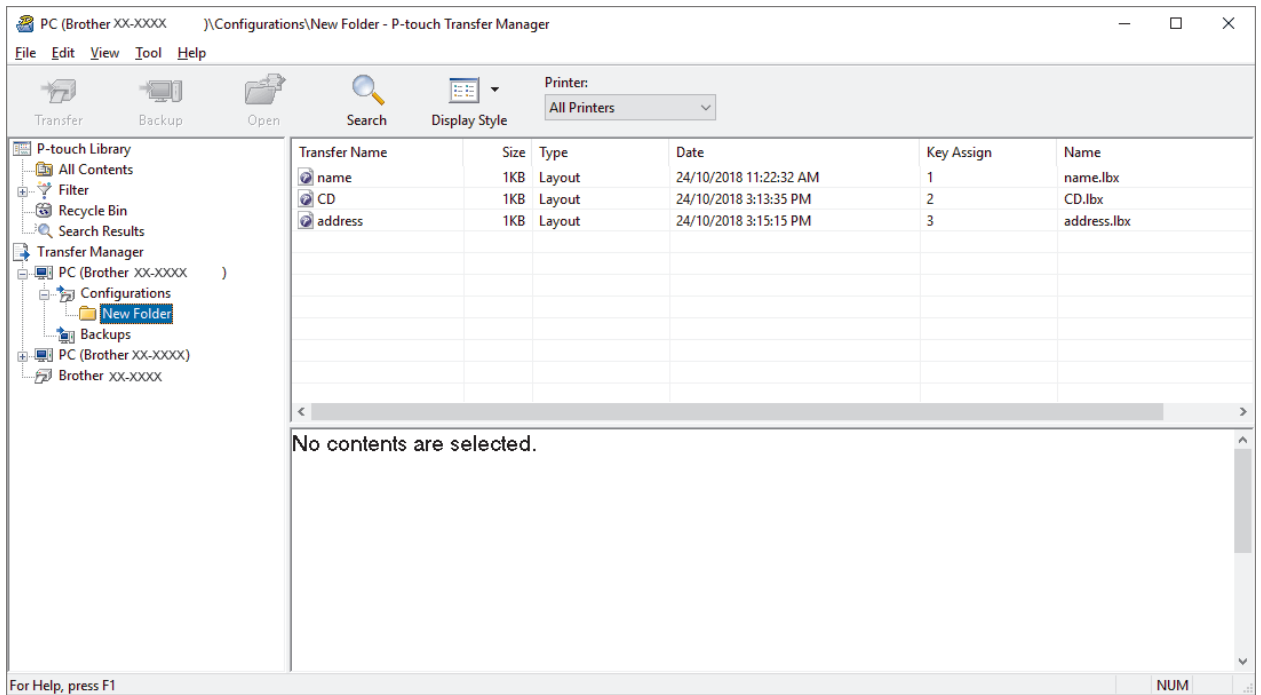

Data type	Maximum number of transferable items	Restriction details
Template	20	<ul style="list-style-type: none"> <li>• Each template can contain a maximum of 20 objects.</li> <li>• Each object can contain a maximum of seven lines.</li> </ul>
Database	20	<ul style="list-style-type: none"> <li>• Only CSV files can be transferred.</li> <li>• Each CSV file can contain a maximum of 255 fields and 65000 records.</li> </ul>



- You can confirm the available space in the transfer file memory by printing the configuration report.
- You can view the templates and other data by selecting:
  - The folder in the **Configurations** folder
  - **All Contents**
  - One of the categories under **Filter**, such as **Layouts**

5. To change the Key Assign number assigned to an item, right-click the item, select the **Key Assign** menu, and then select the Key Assign number you want.

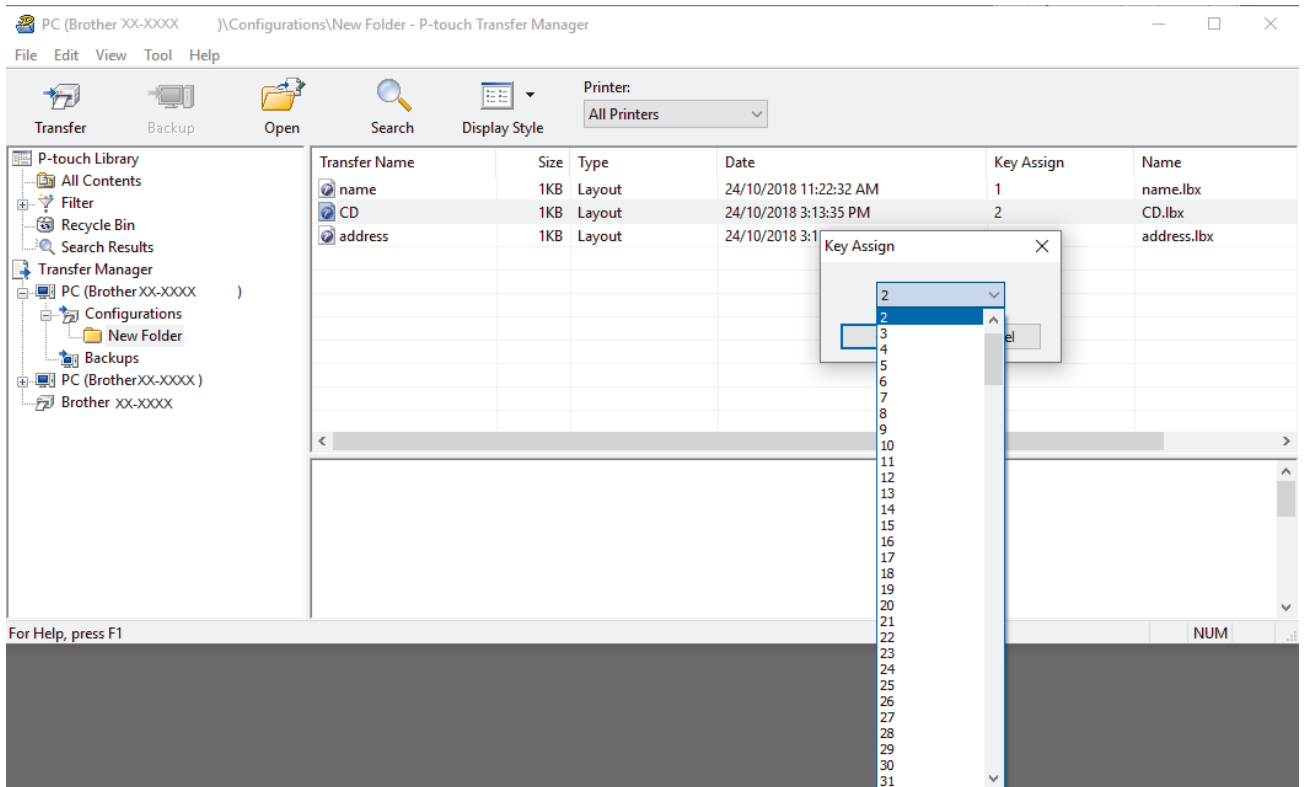

- Except for the data in databases, all data transferred to the printer is assigned a key number.
- If the template or other data transferred to the printer has the same key number as another template already saved in the printer, the new template overwrites the old one. You can confirm the assigned template numbers saved in the printer by backing up the templates or other data.
- If the printer memory is full, remove one or more templates from the printer's memory.

6. To change the template names or other data you want to transfer, click the item you want, and then type the new name.

The number of characters used for the template names may be limited depending on the printer model.

7. Select the folder containing the templates or other data you want to transfer, and then click **Transfer**.

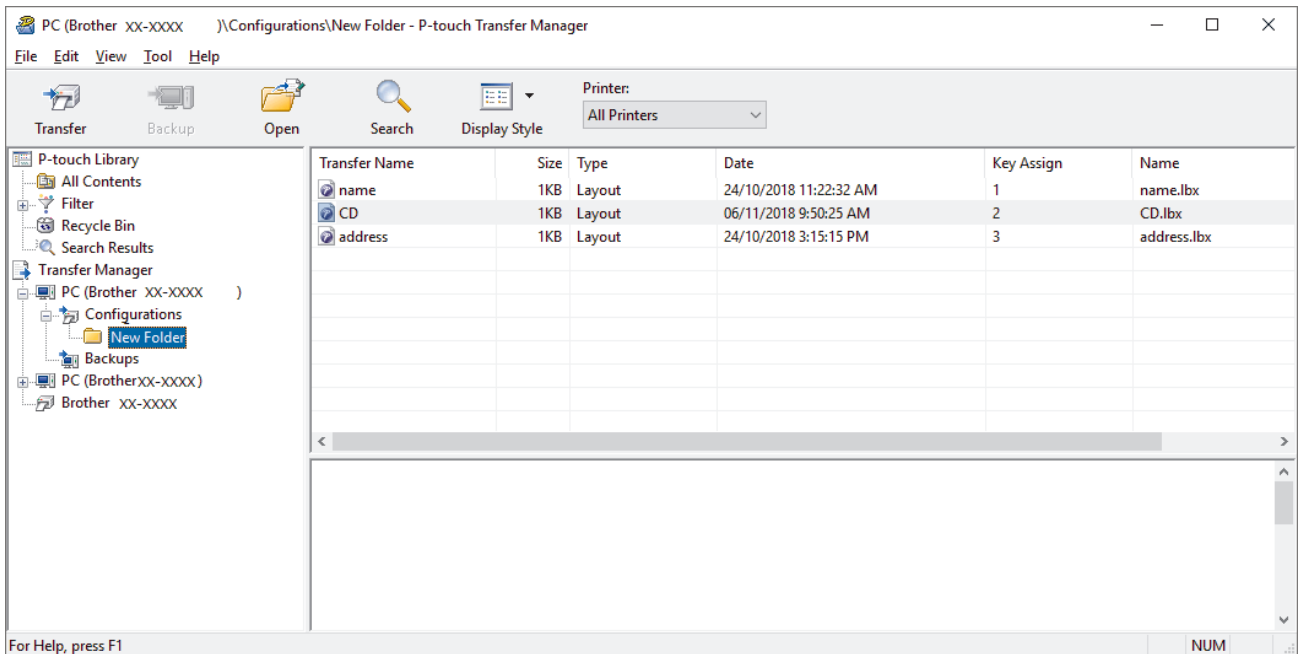

A confirmation message appears.



- You can also transfer individual items to the printer without adding them to a folder. Select the template or other data you want to transfer, and then click **Transfer**.
- Multiple items and folders can be selected and transferred in one operation.

8. Click **OK**.

The selected items are transferred to the printer.



### Related Information

- [About Transferring Templates from the Computer to the Printer \(Windows\)](#)

## Back up Templates or Other Data Saved in the Printer (Windows)



- Backed up templates or other data cannot be edited on the computer.
- Depending on the printer model, backed up templates or data may not be transferable between different models.

1. Connect your computer to the Label Printer and turn the Label Printer on.

The printer model name appears next to a printer icon in the folder view. If you select the printer in the folder view, the current templates and other data stored in the printer appear.

2. Select the printer to back up from, and then click **Backup**.

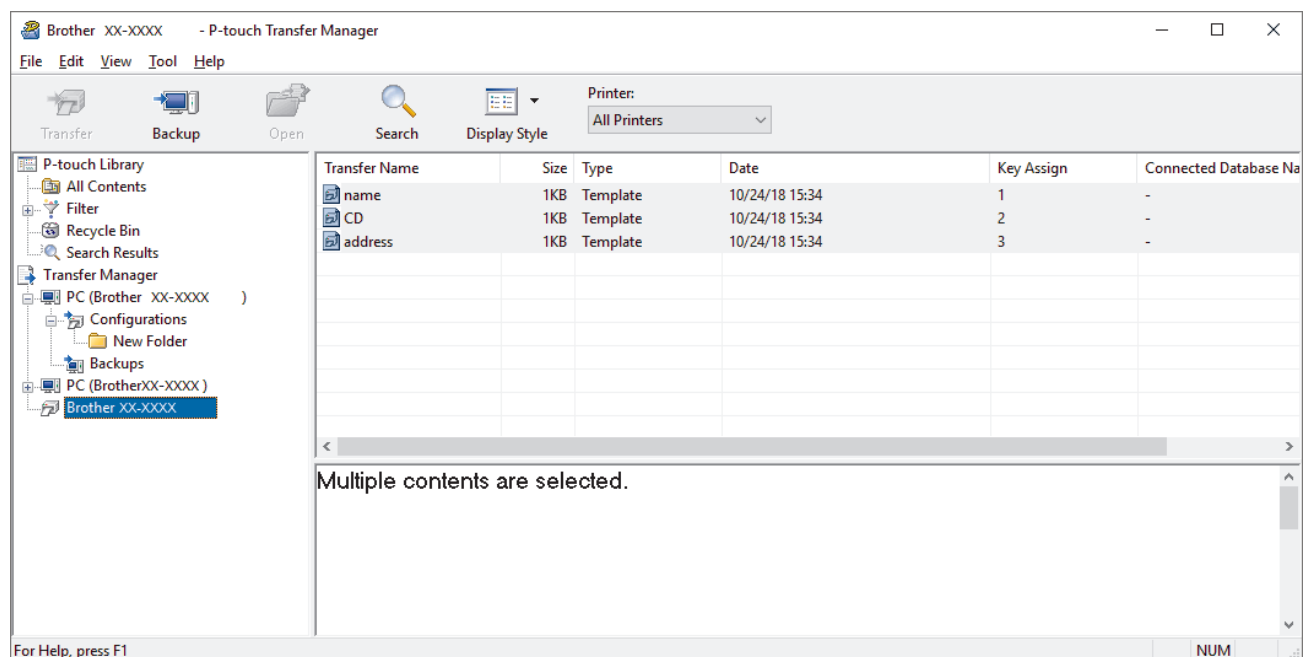

A confirmation message appears.

3. Click **OK**.

A new folder is created under the printer in the folder view. The folder name is based on the date and time of the backup. All of the printer's templates and other data are transferred to the new folder and saved on the computer.



### Related Information

- [Transfer Templates to the Printer Using P-touch Transfer Manager \(Windows\)](#)

## Delete Printer Data (Windows)

To delete all templates and other data saved on the printer, do the following:

1. Connect the computer to the Label Printer and turn the Label Printer on.  
The printer model name appears next to a printer icon in the folder view.
2. Right-click the printer, and then select the **Delete All** menu.

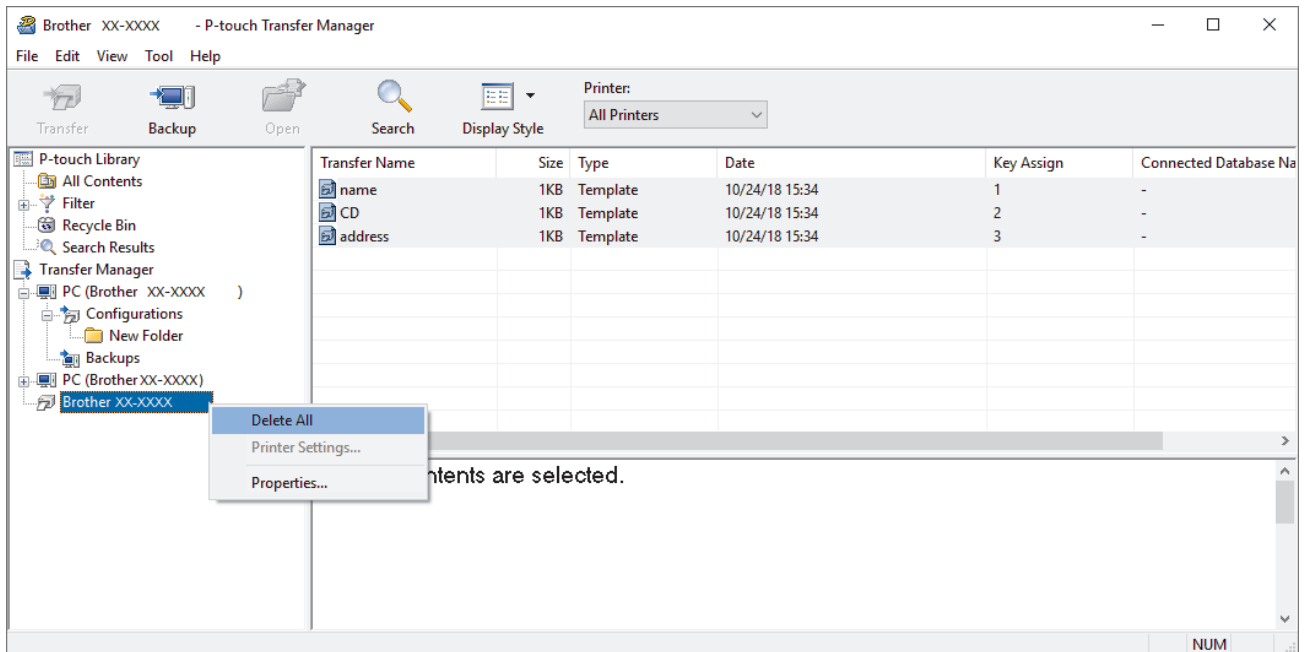

A confirmation message appears.

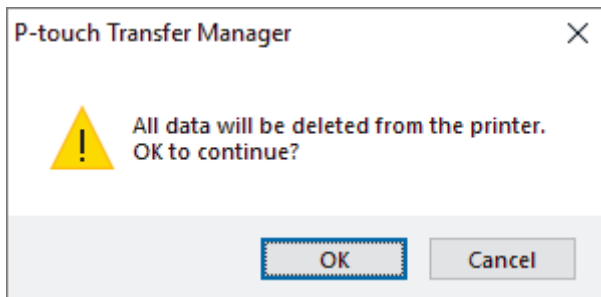

3. Click **OK**.  
All templates and other data saved on the printer are deleted.

### ✓ Related Information

- [Transfer Templates to the Printer Using P-touch Transfer Manager \(Windows\)](#)

## Create Transfer Files and Transfer Package Files (Windows)

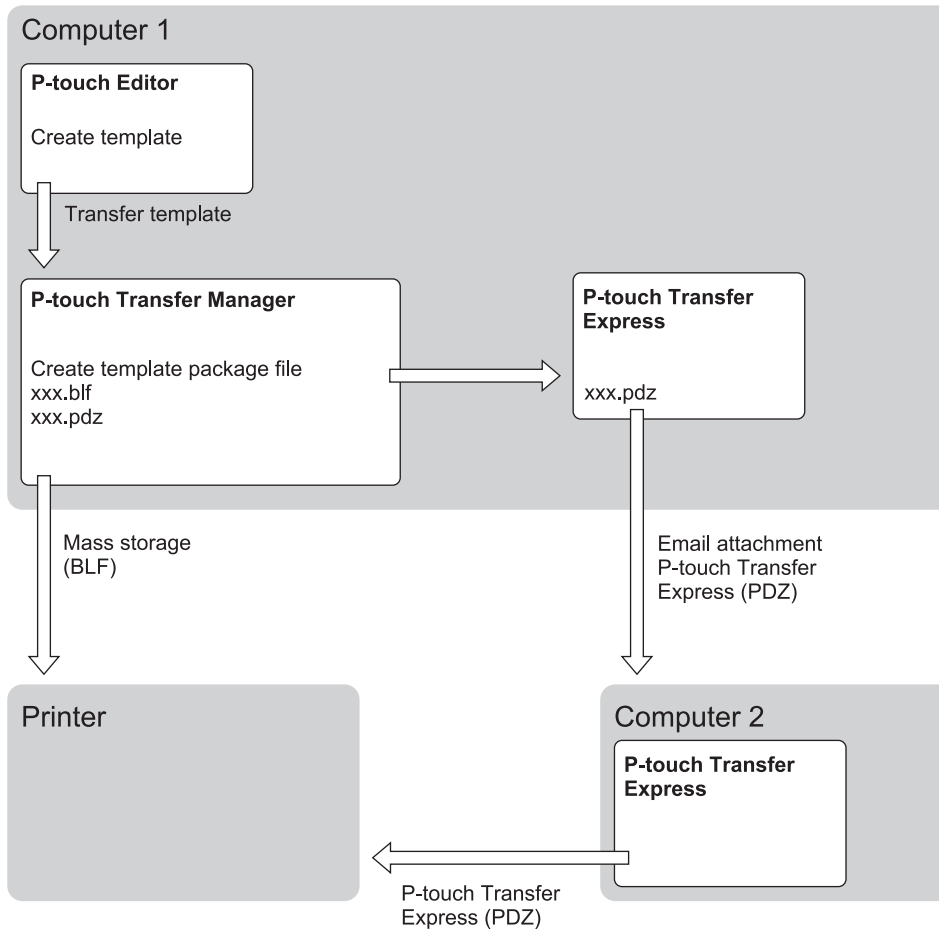

Template Transfer Method		File Format
From a computer	P-touch Transfer Express	PDZ

1. Create the template using P-touch Editor, and then transfer it to P-touch Transfer Manager.



- For more information, see *Related Information*.
- When transferring a new template, make sure you specify a Key Assign number (in P-touch Transfer Manager) that is not currently used. If the specified Key Assign number is already being used, the existing template will be overwritten with the new one.

2. Without connecting the Label Printer to the computer, select the **Configurations** folder in the P-touch Transfer Manager window, and then select the template to save.



You can select multiple templates at the same time.

3. Click **File > Save Transfer File**.

### NOTE

The **Save Transfer File** button appears when the Label Printer is disconnected from the computer or offline.





- If you click the **Save Transfer File** button after selecting **Configurations**, all templates in the folder are saved as the Transfer file (BLF) or Transfer Package file (PDZ).
- You can combine multiple templates into a single Transfer file (BLF) or Transfer Package file (PDZ).

4. In the **Save as type** field, select the template format you want, and then type in the name and save the template.



### Related Information

- [Transfer Templates to the Printer Using P-touch Transfer Manager \(Windows\)](#)
-

## Distribute Templates to be Transferred to Users Without Using P-touch Transfer Manager (Windows)

Transfer templates to the printer using P-touch Transfer Express.

To download the latest version of P-touch Transfer Express, go to your model's **Downloads** page on the Brother support website at [support.brother.com](http://support.brother.com).



- When transferring a new template, make sure you specify a Key Assign number (in P-touch Transfer Manager) that is not currently used. If the specified Key Assign number is already being used, the existing template will be overwritten with the new one.
- This function requires a USB connection.

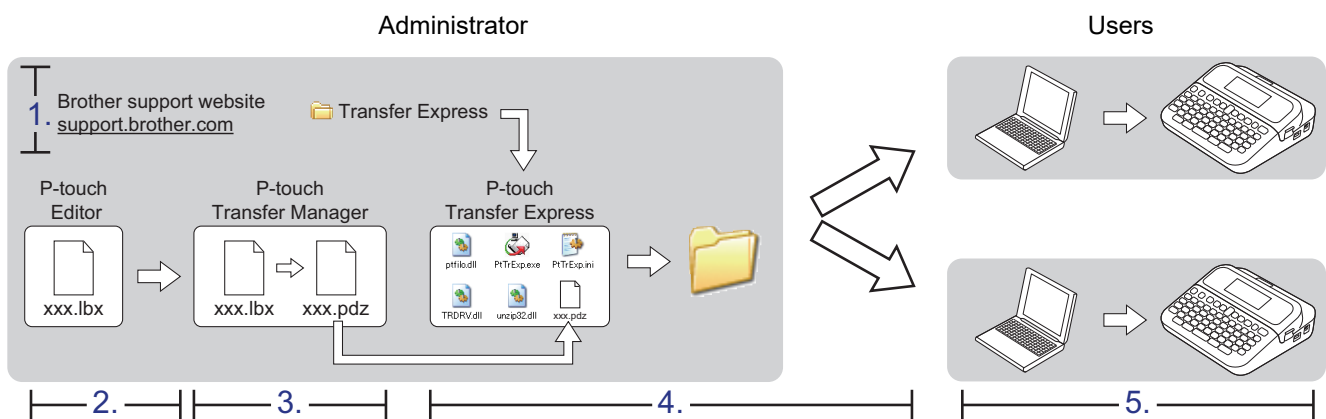

- >> [Administrator Tasks](#)
- >> [User Tasks](#)

### Administrator Tasks

- >> [Preparing P-touch Transfer Express](#)
- >> [Transfer a Template to P-touch Transfer Manager](#)
- >> [Save the Template as a Transfer Package File \(PDZ\)](#)
- >> [Distribute the Transfer Package File \(PDZ\) and P-touch Transfer Express to Others](#)

### Preparing P-touch Transfer Express

The printer driver must be installed before using P-touch Transfer Express.



P-touch Transfer Express is available only in English.

1. Download P-touch Transfer Express to any location on the computer.
2. Decompress the downloaded file (ZIP).

### Transfer a Template to P-touch Transfer Manager



To use the template transfer function, use P-touch Editor 5.4. P-touch Editor 6.0 will be updated in the future.

1. Start P-touch Editor 
  - **Windows 11:**  
Click **Start > Brother P-touch > P-touch Editor**, or double-click the **P-touch Editor** icon on the desktop.

\*Depending on your computer's operating system, the Brother P-touch folder may or may not be created.

- **Windows 10:**

Click **Start > Brother P-touch > P-touch Editor**, or double-click the **P-touch Editor** icon on the desktop.

- **Windows 8.1:**

Click the **P-touch Editor** icon on the **Apps** screen, or double-click the **P-touch Editor** icon on the desktop.

2. Open the template you want.
3. Click **File > Transfer Template > Transfer**.

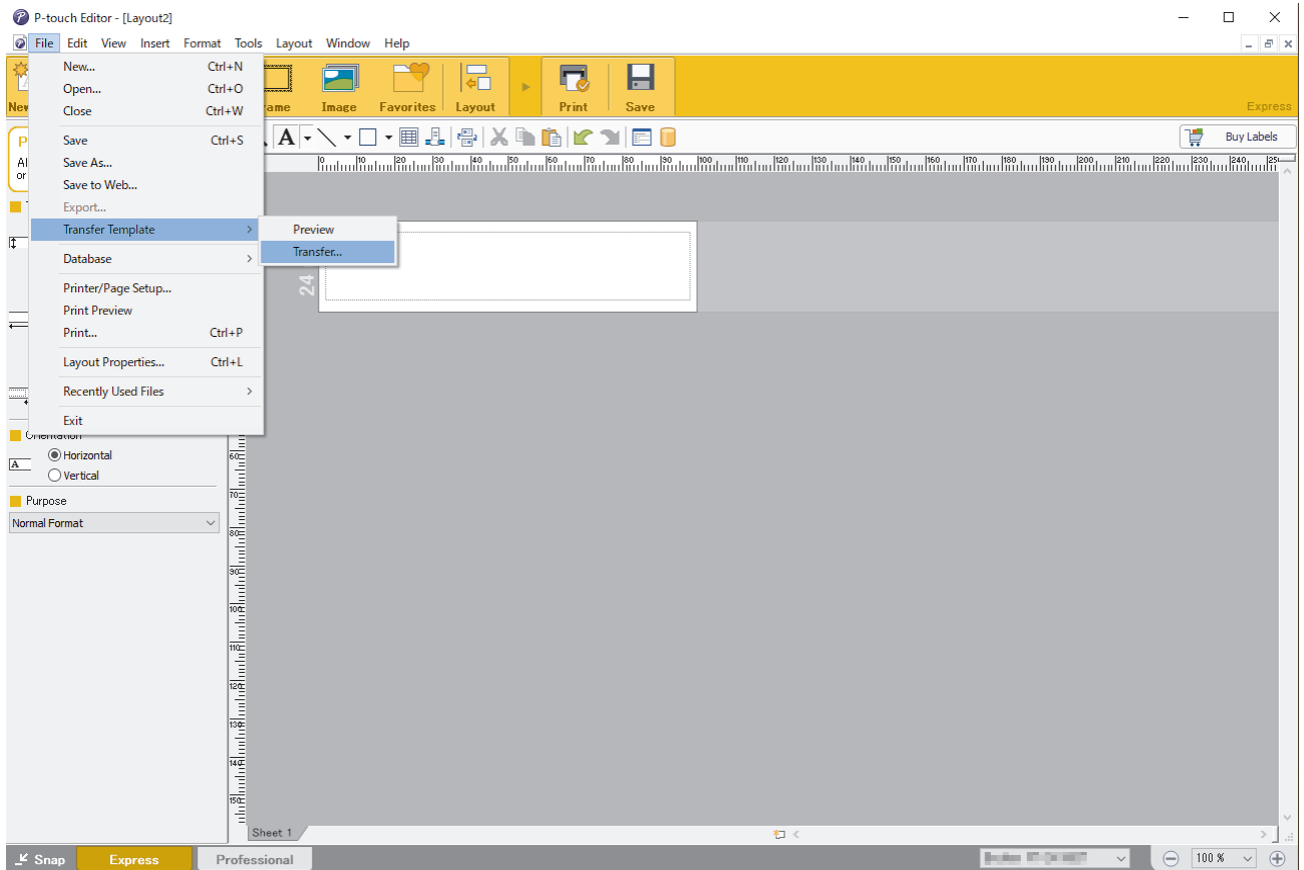

The template is transferred to P-touch Transfer Manager. P-touch Transfer Manager starts.

## Save the Template as a Transfer Package File (PDZ)

To create a file in a format that can be used by P-touch Transfer Express, save the template as a Transfer Package file (PDZ).

1. Select the **Configurations** folder in the P-touch Transfer Manager window.
2. Select the templates you want to distribute.
3. Click **File > Save Transfer File**.



- The **Save Transfer File** option appears only if the printer is disconnected from the computer or offline.
- If you click the **Save Transfer File** option after selecting the **Configurations** folder or a created folder, all templates in the folder are saved as the Transfer Package file (PDZ).
- You can combine multiple templates into a single Transfer Package file (PDZ).

4. Type the name, and then click **Save**.

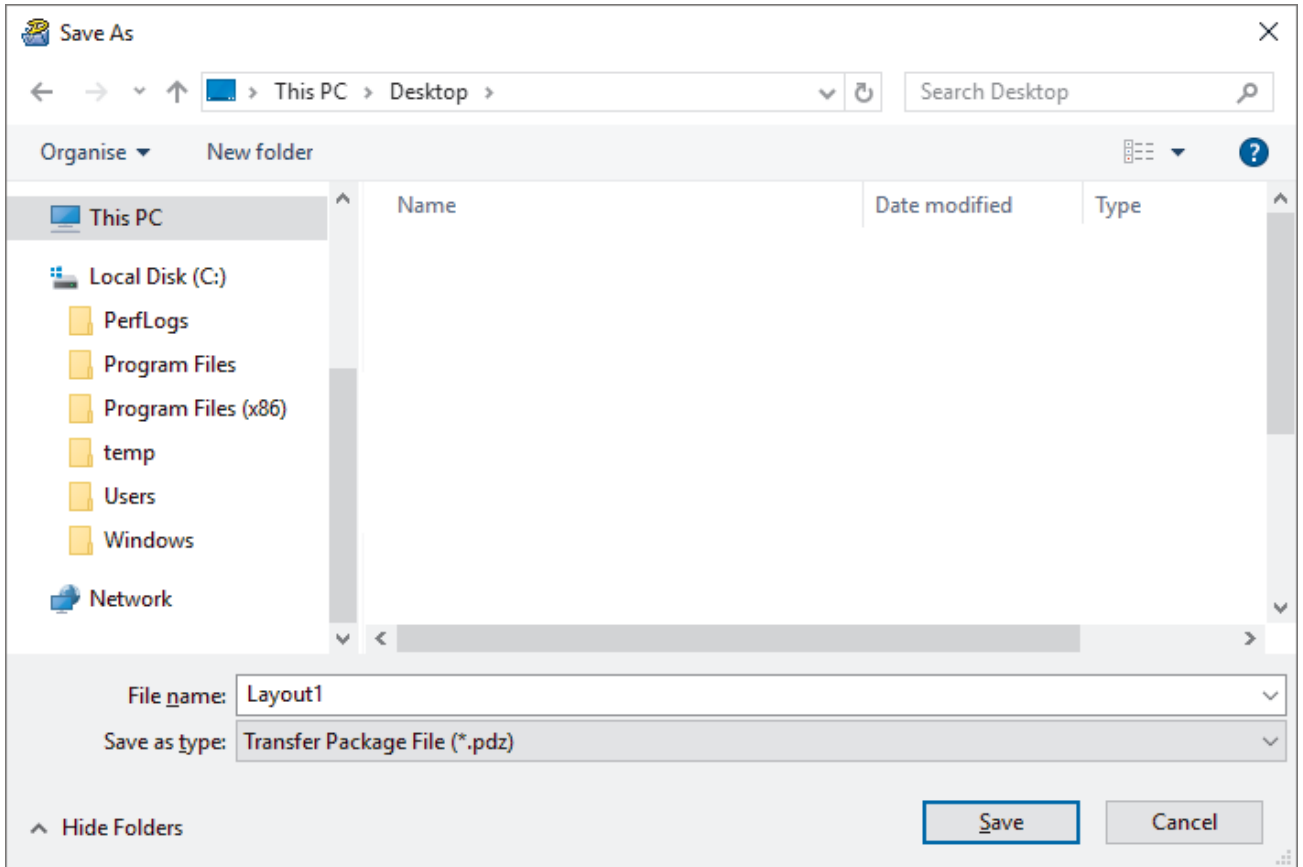

The template is saved as a Transfer Package file (PDZ).

## Distribute the Transfer Package File (PDZ) and P-touch Transfer Express to Others



If you already downloaded P-touch Transfer Express, it is not necessary for the administrator to send the Transfer Express folder. In this case, you can simply move the distributed Transfer Package file to the downloaded folder, and then double-click the **PtTrExp.exe** file.

1. Move the Transfer Package file (PDZ) to the downloads folder.

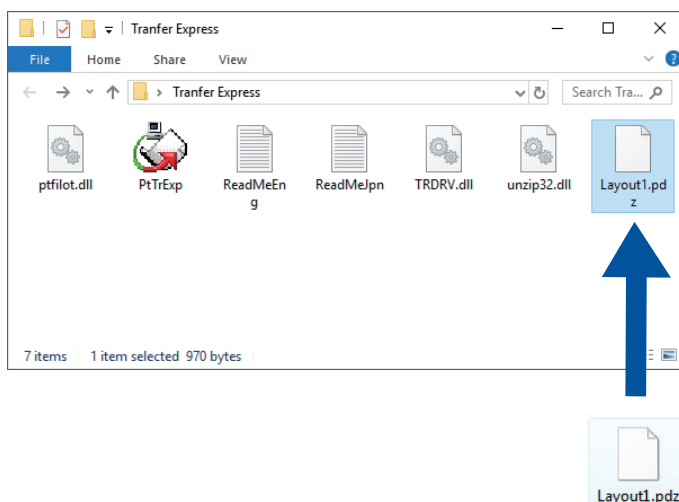

2. Distribute all the files in the downloads folder to others.

## User Tasks

### Transfer the Transfer Package File (PDZ) to Your Printer



Do not turn the power off when transferring templates.

1. Turn the Label Printer on.
2. Connect the printer to the computer using a USB cable.
3. Double-click the **PtTrExp.exe** file received from the administrator.
4. Do one of the following:
  - To transfer a single Transfer Package file (PDZ) within the folder containing the **PtTrExp.exe** file, click **Transfer**.
  - To transfer multiple Transfer Package files (PDZ) within the folder containing the **PtTrExp.exe** file, do the following:

- a. Click **Browse**.

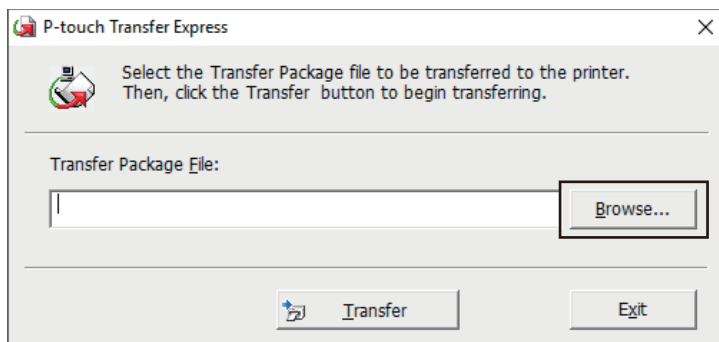

- b. Select the Transfer Package file you want to transfer, and then click **Open**.
  - c. Click **Transfer**.
  - d. Click **Yes**.
5. When completed, click **OK**.



### Related Information

- [Transfer Templates to the Printer \(P-touch Transfer Manager\) \(Windows\)](#)

## Store and Manage Templates (P-touch Library)

- [Edit Templates Using P-touch Library \(Windows\)](#)
- [Print Templates Using P-touch Library \(Windows\)](#)
- [Search Templates Using P-touch Library \(Windows\)](#)

## Edit Templates Using P-touch Library (Windows)

1. Start the P-touch Library.

- **Windows 11:**

Click **Start > Brother P-touch > P-touch Library**.

\*Depending on your computer's operating system, the Brother P-touch folder may or may not be created.

- **Windows 10:**

Click **Start > Brother P-touch > P-touch Library**.

- **Windows 8.1:**

Click the **P-touch Library** icon on the **Apps** screen.

The main window appears.

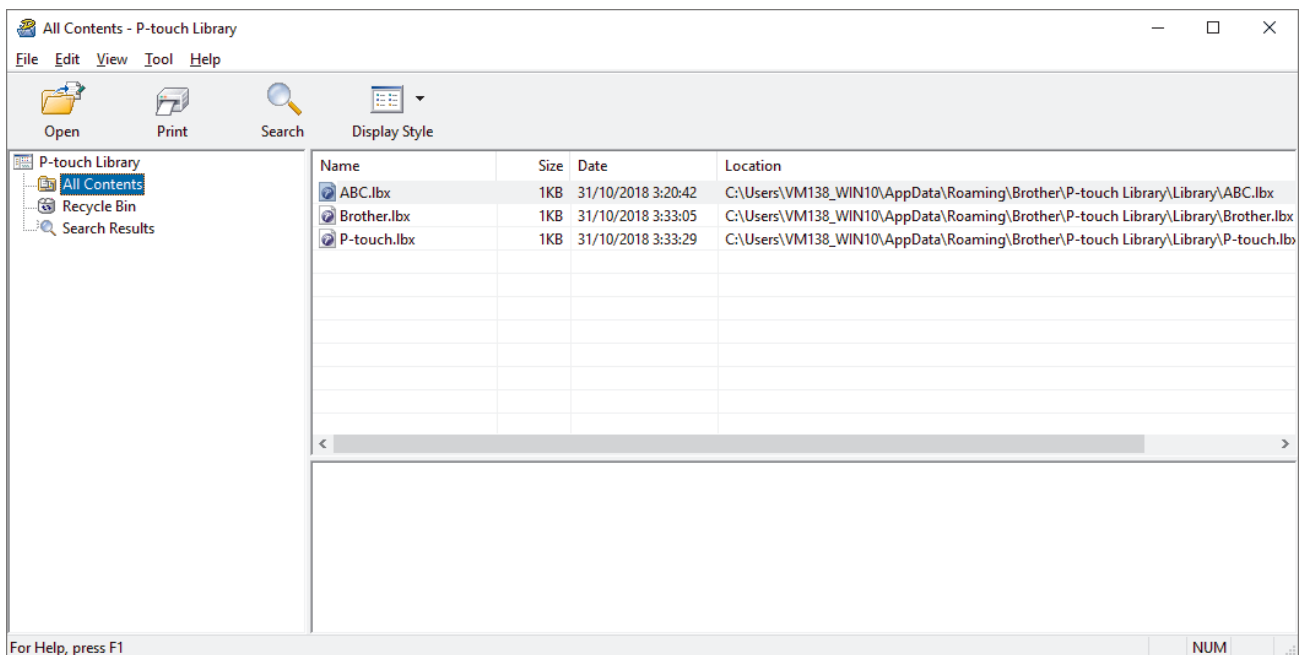

### Overview of the Toolbar Icons

Icon	Button name	Function
	<b>Open</b>	Click to open the selected template.
	<b>Print</b>	Click to print the selected template.
	<b>Search</b>	Click to search for templates registered to P-touch Library.
	<b>Display Style</b>	Click to change the file display style.

2. Select the template you want to edit, and then click **Open**.

You can now edit the template.



### Related Information

- [Store and Manage Templates \(P-touch Library\)](#)

## Print Templates Using P-touch Library (Windows)

1. Start the P-touch Library.

- **Windows 11:**

Click **Start > Brother P-touch > P-touch Library**.

\*Depending on your computer's operating system, the Brother P-touch folder may or may not be created.

- **Windows 10:**

Click **Start > Brother P-touch > P-touch Library**.

- **Windows 8.1:**

Click the **P-touch Library** icon on the **Apps** screen.

The main window appears.

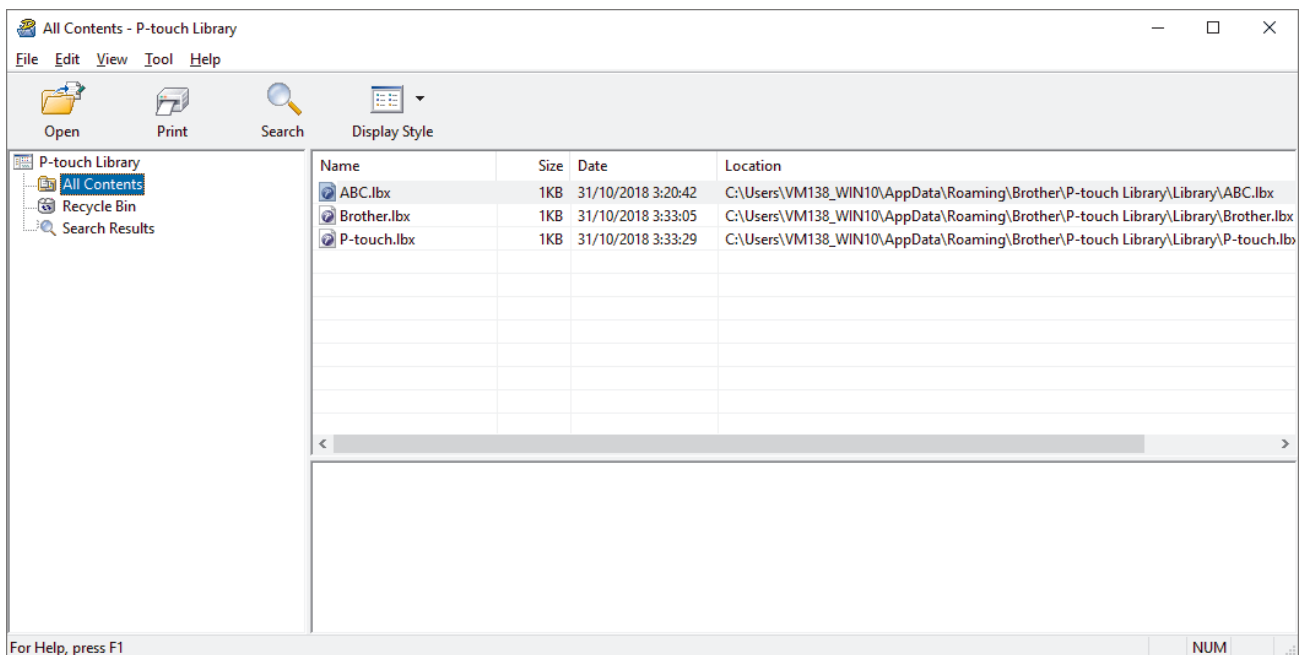

2. Select the template you want to print, and then click **Print**.

The connected Label Printer prints the template.

### ✓ Related Information

- [Store and Manage Templates \(P-touch Library\)](#)



## Search Templates Using P-touch Library (Windows)

1. Start the P-touch Library.

- **Windows 11:**

Click **Start > Brother P-touch > P-touch Library**.

\*Depending on your computer's operating system, the Brother P-touch folder may or may not be created.

- **Windows 10:**

Click **Start > Brother P-touch > P-touch Library**.

- **Windows 8.1:**

Click the **P-touch Library** icon on the **Apps** screen.

The main window appears.

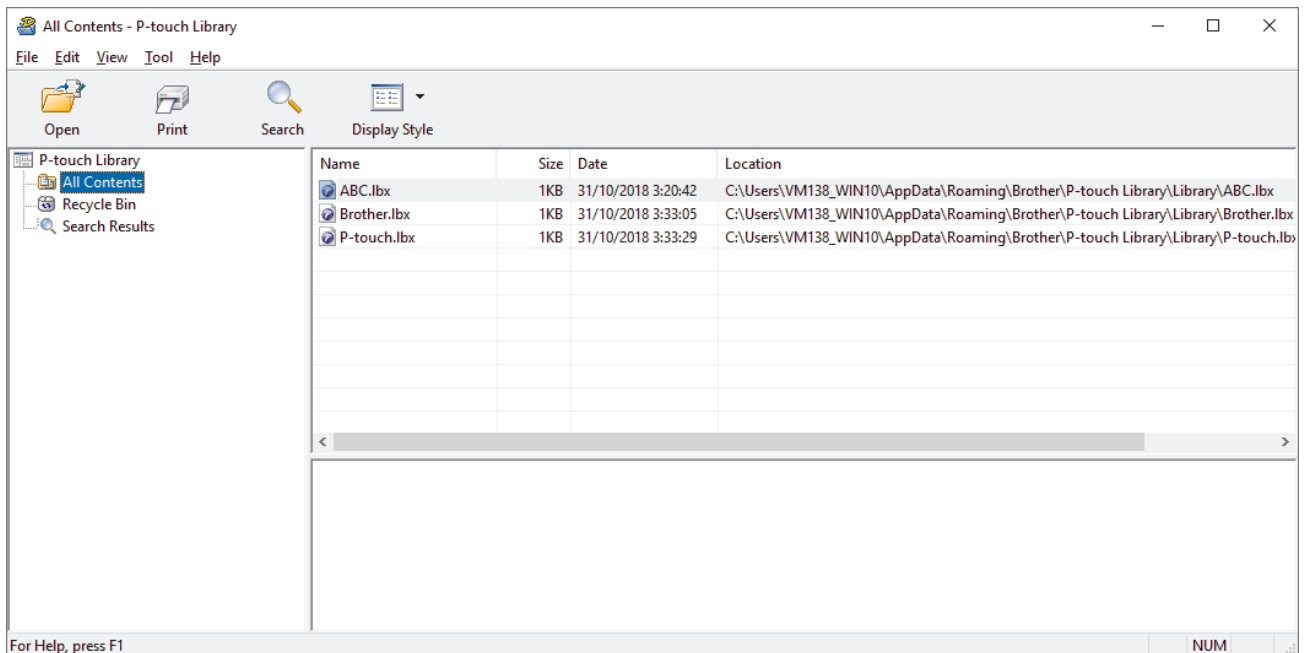

2. Click **Search**.

The **Search** dialog box appears.

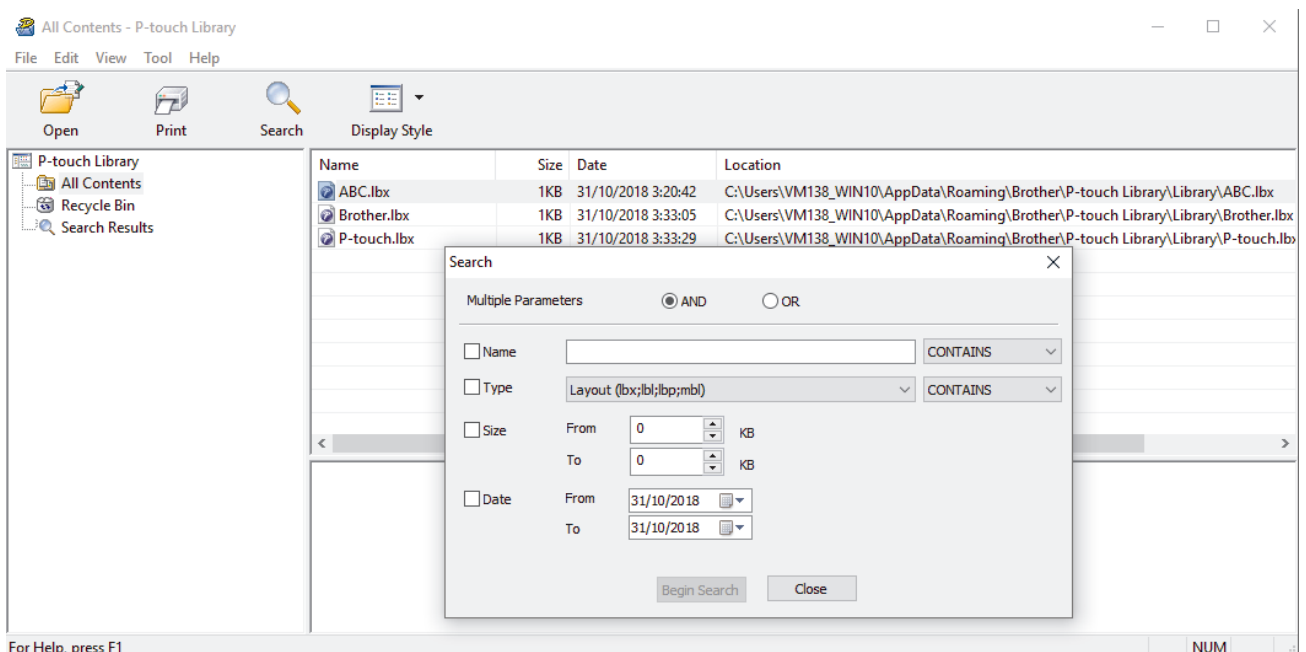

3. Specify the search criteria.

---

The following search criteria are available:

Settings	Details
<b>Multiple Parameters</b>	Determines how the program searches when multiple criteria are specified. If you select <b>AND</b> , the program searches for files meeting all of the criteria. If you select <b>OR</b> , the program searches for files meeting any of the criteria.
<b>Name</b>	Search for a template by specifying the file name.
<b>Type</b>	Search for a template by specifying the file type.
<b>Size</b>	Search for a template by specifying the file size.
<b>Date</b>	Search for a template by specifying the file date.

4. Click **Begin Search**.

The search begins and the search results are displayed.

5. Close the **Search** dialog box.

To confirm the search results, click **Search Results** in the folder view.



---

You can register templates to P-touch Library by dragging and dropping them into the **All Contents** folder or to the folder list.

---



### Related Information

- [Store and Manage Templates \(P-touch Library\)](#)
-

## Routine Maintenance

- [Maintenance](#)

## Maintenance

Always remove the batteries and disconnect the AC Adapter before cleaning the Label Printer.

- >> [Clean the Unit](#)
- >> [Clean the Print Head](#)
- >> [Clean the Tape Cutter](#)

### Clean the Unit

1. Wipe any dust and marks from the Label Printer using a soft, dry cloth.
2. Use a slightly dampened cloth on difficult to remove marks.



Do not use paint thinner, benzene, alcohol or any other organic solvent. These may deform or damage the case of your Label Printer.

### Clean the Print Head

Streaks or poor quality characters on printed labels generally indicate that the Print Head is dirty. Clean the Print Head using a cotton swab or the optional Print Head Cleaning Cassette (TZe-CL4).

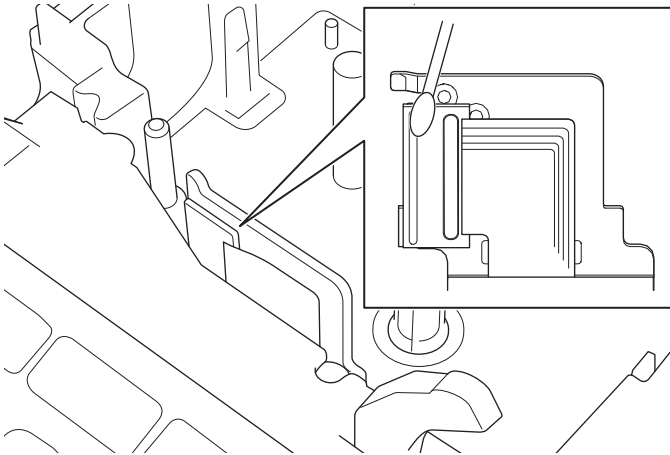

- Do not touch the Print Head directly with your bare hands.
- Read and follow the instructions provided with the Print Head Cleaning Cassette.

### Clean the Tape Cutter

Tape adhesive can build up on the cutter blade after repeated use, taking the edge off the blade, which may result in the tape jamming in the cutter.

---

About once a year, wipe the cutter blade using a cotton swab moistened with Isopropyl alcohol (rubbing alcohol).

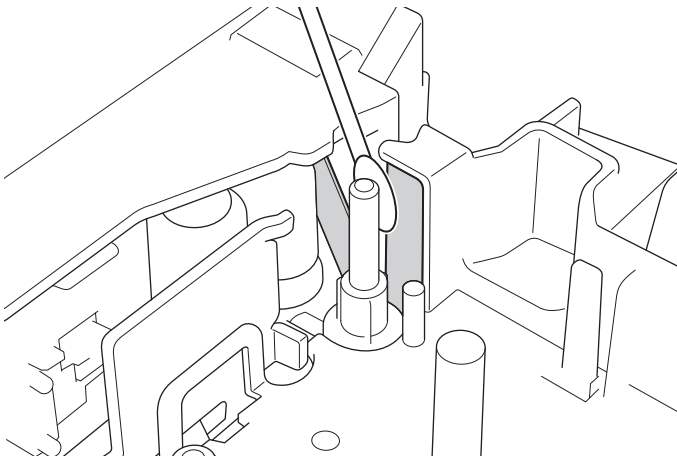

- Do not touch the cutter blade directly with your bare hands.
  - Use isopropyl alcohol according to the manufacturer's guidelines.
- 



### Related Information

- [Routine Maintenance](#)
-

## Troubleshooting



- [If You Are Having Difficulty with Your Label Printer](#)
- [Error and Maintenance Messages](#)
- [Check the Version Information](#)
- [Reset the Label Printer](#)

## If You Are Having Difficulty with Your Label Printer

This chapter explains how to resolve typical problems you may encounter when using the Label Printer.

If you still have problems, see *Related Information*. If after reading the topics you are unable to resolve the problem, visit the Brother support website at [support.brother.com](http://support.brother.com).

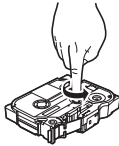
Problem	Solution
The Label Printer does not print.	<ul style="list-style-type: none"> <li>• Check that the Tape Cassette is inserted correctly.</li> <li>• If the Tape Cassette is empty, replace it. To order supplies and accessories, visit <a href="http://www.brother.com">www.brother.com</a>.</li> <li>• Check that the Tape Cassette Compartment Cover is securely closed.</li> <li>• Check that the Label Printer is on.</li> <li>• Check that the computer's or mobile device's Bluetooth setting is on.</li> <li>• Check that the Label Printer is connected to the computer or your mobile device via Bluetooth.</li> <li>• Check that the Label Printer is selected in the Brother iPrint&amp;Label app.</li> <li>• Check that the Label Printer is not paired with another device.</li> <li>• Make sure the Label Printer and your mobile device or computer are close enough to communicate.</li> <li>• Check that the automatic Bluetooth reconnection setting of another computer or mobile device is not enabled.</li> <li>• Make sure no devices that emit radio waves (for example, a microwave oven) are located nearby.</li> <li>• Check that the correct printer driver is installed when printing from a computer.</li> <li>• Connect the Label Printer to your computer using the USB Cable (included) when printing from a computer.</li> <li>• If the Print Head is dirty, clean it with a cotton swab or optional Print Head Cleaning Cassette (TZe-CL4).</li> </ul>
<ul style="list-style-type: none"> <li>• The tape does not feed correctly.</li> <li>• The tape gets stuck inside the Label Printer.</li> </ul>	<ul style="list-style-type: none"> <li>• If the tape is bent, cut off the bent section.</li> <li>• If the tape is jammed, remove the Tape Cassette, remove the jammed tape, and then cut off any damaged tape.</li> <li>• Check that the end of the tape exits through the Tape Guide.</li> <li>• Confirm that the tape is pointed at the Tape Exit Slot.</li> <li>• Remove the Tape Cassette and insert it again.</li> </ul>
An error occurred when using a mobile app.	Go to your mobile application's settings menu and select <b>Support &gt; FAQs &amp; Troubleshooting</b> .
The screen has locked.	<ul style="list-style-type: none"> <li>• Reset the internal memory to the factory settings. For more information, see <i>Related Topics</i>.</li> <li>• Disconnect the AC Adapter and remove the batteries for at least 10 minutes.</li> </ul>
The LCD remains blank after turning the power on.	Check that the batteries are correctly installed or that the AC Adapter included with your Label Printer is correctly connected.
The LCD messages are displayed in a foreign language.	Set the LCD language you want. For more information, see <i>Related Topics</i> .
The Label Printer stops while printing a label.	<ul style="list-style-type: none"> <li>• Replace the Tape Cassette if striped tape is visible, as this indicates that you have reached the end of the tape.</li> <li>• Replace all batteries or connect the AC Adapter directly to the Label Printer.</li> </ul>
Previously saved label files are not available.	All files saved in the internal memory are deleted when the batteries are weak or the AC Adapter is disconnected.
<ul style="list-style-type: none"> <li>• I cannot install the Printer Driver even if I</li> </ul>	<p>If you cannot use your Label Printer even though you have installed the Printer Driver:</p> <ol style="list-style-type: none"> <li>1. Download the Printer Driver Uninstaller from your model's page at <a href="http://support.brother.com">support.brother.com</a>.</li> </ol>

Problem	Solution
<p>follow the correct procedure. (Windows)</p> <ul style="list-style-type: none"> <li>I cannot see my printer listed in P-touch Editor even though I have installed the Printer Driver. (Windows)</li> </ul>	<ol style="list-style-type: none"> <li>Use the Printer Driver Uninstaller to remove the printer information.</li> <li>Run the Printer Driver Installer again and follow the on-screen instructions to proceed with the installation.</li> </ol>
<p>The ink ribbon is separated from the ink roller.</p>	<p>If the ink ribbon is damaged, replace the Tape Cassette. If it is not, leave the tape uncut and carefully remove the Tape Cassette, and then wind the loose ink ribbon back onto the spool.</p> 
<p>Printed barcodes or QR codes cannot be read.</p>	<ul style="list-style-type: none"> <li>Change the tape. (Recommended: Black on white tape)</li> <li>Enlarge the barcodes or QR codes using your barcode application, if possible.</li> </ul>
<p>I do not know the version number of the firmware for the Label Printer.</p>	<p>You can confirm the firmware version number and other information on the LCD. For more information, see <i>Related Topics</i>.</p>
<p>When the label is printed, there is too much margin (space) on both sides of the text.</p>	<ul style="list-style-type: none"> <li>Select <b>Small Margin</b>, <b>Chain</b>, or <b>No Cut</b> options for smaller margins. For more information, see <i>Related Topics</i>.</li> <li>After the last label prints, press  and  simultaneously to feed the tape, and then eject and cut the last label. Note that the Label Printer will feed approximately 23 mm of tape before the next new label when you use this method.</li> </ul>
<p>The font size cannot be increased.</p>	<p>The font is already the maximum size for the width of the label, or the label length has been set, so there is a limit on the font size to prevent exceeding the set length.</p>
<p>When multiple labels are printed, the last label is cut incorrectly.</p>	<p>When <b>Chain</b> is enabled, feed the tape to eject the last printed label.</p>
<p>I cannot update the printer's firmware using the P-touch Update Software, Transfer Update Software, Mac Update Express, or Mac Update Tool.</p>	<p>Restart the printer and then try to update the firmware again. Do not press any buttons during the firmware update until the Home Screen is displayed automatically.</p>
<p>The Label Printer does not operate normally.</p>	<ul style="list-style-type: none"> <li>Reset the internal memory to the factory settings. For more information, see <i>Related Topics</i>.</li> <li>Disconnect the AC Adapter and remove the batteries for at least 10 minutes.</li> </ul>

## Related Information

- [Troubleshooting](#)

### Related Topics:

- [Reset the Label Printer](#)
- [Set Language](#)
- [Check the Version Information](#)
- [Tape Cutting Options](#)



## Error and Maintenance Messages

Message	Cause/Remedy
Barcode error Record: XXXXX Field: XXXXX	There was an attempt to print barcode labels from a database. The Label Printer displays this message when the selected range of the database includes invalid characters or numbers not supported by the barcode protocol.
Check no. of digits entered	The number of digits entered in the barcode data does not match the number of digits set in the barcode parameters. Enter the correct number of digits.
Cutter malfunction	If the tape is jammed in the Cutter unit, remove the tape. Turn the Label Printer off and then on again before continuing.
Label too long	The printed label length using the text entered is longer than 999 mm. Edit the text so that the label length is less than 999 mm.
System error XX	Contact Brother customer service.
Text too long	The printed label length using the text entered is longer than the length setting. Edit the text to fit within the set length or change the length setting.



### Related Information

- [Troubleshooting](#)

## Check the Version Information

You can confirm the firmware version number and other information on the LCD. You may need this information if you call Brother regarding a question or a warranty.

1. Press .
2. Press ◀ or ▶ to display [Settings], and then press **OK**.
3. Press ▲ or ▼ to display [Version Information], and then press **OK**.



### Related Information

- [Troubleshooting](#)
-

## Reset the Label Printer

Reset the internal memory of your Label Printer to clear all saved label files, or if the Label Printer is not operating correctly.

- [Reset Using the LCD](#)

## Reset Using the LCD

1. Press .
2. Press **◀** or **▶** to display [Settings], and then press **OK**.
3. Press **▲** or **▼** to display [Reset], and then press **OK**.
4. Press **▲** or **▼** to display the reset method, and then press **OK**.  
A message appears asking you to confirm your reset option.
5. Press **OK**.



If using the [Reset All Settings] or [Factory Settings] reset options, you will need to set your preferred default language again after the reset.

Reset Options	Details
Reset All Settings	File memory is NOT cleared. Settings data is cleared and all settings are reset to the factory settings.
Erase All Content	File memory is cleared. Settings data is NOT cleared and settings remain as currently configured.
Factory Settings	File memory, labels, and customised settings are reset to the factory settings.



### Related Information

- [Reset the Label Printer](#)

## Appendix

- [Specifications](#)
- [Brother Help and Customer Support](#)

## Specifications

- >> [Printing](#)
- >> [Size](#)
- >> [Interface](#)
- >> [Environment](#)
- >> [Power Supply](#)
- >> [Media](#)
- >> [Memory](#)
- >> [Compatible Operating Systems](#)

### Printing

<b>Print Speed</b> (Depending on the media used)	Maximum 30 mm/s
<b>Maximum Print Height</b>	18.0 mm (when using 24 mm tape) <sup>1</sup>

<sup>1</sup> The actual character size may be smaller than the maximum print height.

### Size

<b>Weight</b>	Approximately 990 g (without batteries and Tape Cassette)
<b>Dimensions</b>	Approximately 202 mm (W) x 87 mm (H) x 199 mm (D)
<b>LCD</b>	320 dpi x 120 dpi

### Interface

<b>USB</b>	USB Ver.2.0 (Full Speed) (Micro B)
<b>Bluetooth</b>	Bluetooth Ver.5.0 SPP: iAP2

### Environment

<b>Operating Temperature</b>	Between 10°C and 35°C
<b>Operating Humidity</b>	Between 20% and 80% Maximum wet bulb temperature: 27°C

### Power Supply

<b>Battery</b>	Six AA alkaline batteries (LR6) AC Adapter (AD-E001A)
----------------	--

### Media

<b>Tape Width</b>	Standard TZe Tape Cassette: 3.5 mm, 6 mm, 9 mm, 12 mm, 18 mm, 24 mm
<b>No. of Lines</b>	24 mm tape: 1 - 7 lines 18 mm tape: 1 - 5 lines 12 mm tape: 1 - 3 lines 9 mm tape: 1 - 2 lines 6 mm tape: 1 - 2 lines 3.5 mm tape: 1 line

---

## Memory

Text Buffer	Maximum 280 characters
File Storage	Maximum 99 files

## Compatible Operating Systems

For the latest list of compatible software, visit [support.brother.com](http://support.brother.com).

## Related Information

- [Appendix](#)
-

## Brother Help and Customer Support

If you need help with using your Brother product, visit [support.brother.com](http://support.brother.com) for FAQs and troubleshooting tips. You can also download the latest software, drivers and firmware, to improve the performance of your machine, and user documentation, to learn how to get the most from your Brother product.

Further product and support information is available from your local Brother office website. Visit [www.brother.com](http://www.brother.com) to find the contact details for your local Brother office and to register your new product.



### Related Information

- [Appendix](#)
-



brother



UK  
Version A