



User's Guide

RJ-3235B

RJ-3255WB

RJ-4235B

RJ-4255WB

Table of Contents

Before You Use Your Printer	1
Definitions of Notes	2
Safety Precautions	3
General Precautions	4
Trademarks and Licences	6
Open Source Licensing Remarks	7
Important Note	8
Set Up Your Printer	9
Parts Description	10
Control Panel Overview	12
LCD Overview	14
LED Patterns and Indications.....	16
Install the Rechargeable Li-ion Battery	18
Charge the Rechargeable Li-ion Battery.....	20
Turn Power On/Off	23
Set the Language	24
Restrict Access to Administration Menu Items	25
Set the Menu Security.....	26
Load the Roll	27
Attach the Belt Clip.....	32
Install Software	33
Install Printer Drivers and Software on a Computer.....	34
Available Applications.....	35
Connect the Printer to a Computer or Mobile Device.....	36
Connect Using a USB Cable	37
Connect Using Wi-Fi	38
Connect Using Bluetooth Connection	41
Connect the Printer to a Mobile Device Using NFC (Android)	42
Create and Print Labels Using Your Computer	43
Create and Print Labels Using P-touch Editor (Windows)	44
Tips for Better Printing Results When Using P-touch Editor	45
Create Labels and Print without Installing Software and Drivers	46
Print Using the USB Interface (Mass Storage Mode).....	47
Notes on Printing Images without Using the Printer Driver	48
Print Labels Using the Printer Driver (Windows).....	49
Print Labels Using Mobile Devices	50
Compatible Printing Apps.....	51
AirPrint Overview	52
Transfer Templates Created on a Computer to the Printer Using a Mobile Device	53
Print Labels Using Barcode Scanner or Other Devices (P-touch Template)	54
P-touch Template Operations Overview.....	55
Create and Print Labels Using P-touch Editor (Windows)	56
Transfer a Template or Other Data from the Computer to the Printer (Windows).....	57
Transfer Multiple Items from the Computer to the Printer (Windows).....	59

Specify the Barcode Scanner Settings (Windows).....	60
Connect the Printer to a Barcode Scanner Using Bluetooth	61
Try the P-touch Template Function Using the Barcode List.....	62
Recall and Print the Template Transferred to the Printer (Recall Printing)	63
Insert Information into a Template Transferred to the Printer and Print It (Merge Printing)	67
Print the Template Linked to the Database (Database Lookup Printing).....	71
Print Transferred Templates in Serialised (Numerical) Order (Numbered (Serialised Number) Printing)	75
Barcodes Used for Specifying Settings	77
Transfer Templates to the Printer Using Your Computer (Windows)	80
Create Transfer Files and Transfer Package Files (Windows).....	81
Network	83
Important Information for Security	84
Wireless Network Settings	85
Use the Wireless Network	86
Enable/Disable Wi-Fi.....	88
Network Features.....	89
Synchronise Time with the SNTP Server Using Web Based Management	90
Brother Management Tools	94
Security	95
Before You Use Security Features	96
Configure Certificates for Device Security	97
Security Certificate Features Overview	98
How to Create and Install a Certificate	99
Create a Self-signed Certificate	100
Create a Certificate Signing Request (CSR) and Install a Certificate from a Certificate Authority (CA)	101
Import and Export the Certificate and Private Key	105
Import and Export a CA Certificate.....	108
Manage Multiple Certificates	111
Use SSL/TLS	112
Introduction to SSL/TLS	113
Manage Your Network Machine Securely Using SSL/TLS.....	116
Print Documents Securely Using SSL/TLS	120
Use SNMPv3.....	122
Manage Your Network Machine Securely Using SNMPv3	123
Use IEEE 802.1x Authentication for Your Network	124
What Is IEEE 802.1x Authentication?	125
Configure IEEE 802.1x Authentication Using Web Based Management (Web Browser)	126
IEEE 802.1x Authentication Methods.....	128
Update	129
Update P-touch Editor.....	130
Update the Firmware.....	131
Printer Settings	132
Change Printer Settings Using the BRConfiguration Tool (Windows).....	133
The Paper Size Setup (For Windows).....	134
Change Printer Settings Using Web Based Management	139





Set or Change a Login Password for Web Based Management	140
Confirm Printer Settings	141
Change Printer Settings Using the Printer	142
Settings Tables	143
Routine Maintenance	146
Maintenance	147
Troubleshooting	150
If You Are Having Difficulty with Your Machine	151
Error and Maintenance Messages	152
Printing Problems	154
Network Problems	157
Version Information	159
Reset the Printer	160
Battery Charger (Optional) Problems	161
Charging Cradle (Optional) Problems	162
Linerless Platen Kit (Optional) Problems	163
Appendix	164
Specifications	165
Software Development Kit	169
LabelCLT	170
LabelCLT Overview	171
Transfer the Template Data File with LabelCLT	172
Transferring a PDZ Firmware File via USB: Example	173
Optional Accessories	179
Battery Charger (Optional: PA-BC-003)	180
Label Peeler (Optional: PA-LP-007)	186
Linerless Platen Kit (Optional: PA-LPR-004/PA-LPR-001)	191
Charging Cradle (Optional: PA-CR-005)	194
4-bay Charging Cradle (Optional: PA-4CR-003)	202
Charging Cradle (Optional: PA-CR-002A)	210
Product Dimensions	216
Brother Help and Customer Support	227
Compatible Operating Systems	228

Before You Use Your Printer

- [Definitions of Notes](#)
- [Safety Precautions](#)
- [General Precautions](#)
- [Trademarks and Licences](#)
- [Open Source Licensing Remarks](#)
- [Important Note](#)

Definitions of Notes

We use the following symbols and conventions throughout this User's Guide:

 DANGER	DANGER indicates an imminently hazardous situation which, if not avoided, will result in death or serious injuries.
 WARNING	WARNING indicates a potentially hazardous situation which, if not avoided, could result in death or serious injuries.
 CAUTION	CAUTION indicates a potentially hazardous situation which, if not avoided, may result in minor or moderate injuries.
IMPORTANT	IMPORTANT indicates a potentially hazardous situation which, if not avoided, may result in damage to property or loss of product functionality.
NOTE	NOTE specifies the operating environment, conditions for installation, or special conditions of use.
	The tips icon indicates helpful hints and supplementary information.
Bold	Bold style identifies buttons on the machine's control panel or computer screen.
<i>Italics</i>	Italicised style emphasises an important point or refers you to a related topic.
Courier New	Courier New font identifies messages shown on the machine's LCD.



Related Information

- [Before You Use Your Printer](#)

Safety Precautions

IMPORTANT

- DO NOT remove the labels affixed to the printer. These labels provide operational information and indicate the printer's model number.
- DO NOT push the power button or LED indicator with an object that has a sharp point, such as a pen. This could damage the button or LED.
- DO NOT transport the printer while cables are connected to the printer's DC connector or USB port. The connector and ports could be damaged.
- DO NOT store the printer in an area exposed to high temperatures, high humidity, direct sunlight, or dust. These could cause discolouration or a malfunction.



Related Information

- [Before You Use Your Printer](#)
-

General Precautions

Printer

- Depending on the area, material, and environmental conditions, the label may unpeel or become permanently affixed, and the colour of the label may change or be transferred to other objects. Before affixing the label, check the environmental conditions and the material. Test the label by affixing a small piece of it to an inconspicuous area of the intended surface.
- When not in use for a period of time, remove the Label Roll from the printer.
- This printer uses thermal paper. If the printed paper is marked with ink, for example written on or stamped, the ink may cause the printed text to fade or become discoloured. In addition, the applied ink may take some time to dry.

Printed text may fade or become discoloured if the label comes into contact with any of the following: vinyl chloride products, leather goods such as wallets and purses, organic compounds such as alcohol, ketones, or esters, adhesive tape, erasers, rubber mats, magic marker ink, permanent marker ink, correction fluid, carbon, glue, diazo sensitised paper, hand lotion, hair care products, cosmetics, water, or sweat.

- DO NOT touch the printer with wet hands.
- DO NOT use folded, wet, or damp paper, otherwise a paper misfeed or malfunction may occur.
- DO NOT touch paper or labels with wet hands, otherwise a malfunction may occur.
- The LCD screens are for illustration purpose only and may differ from the actual screen.

Printer, AC Adapter (Optional), Car Adapter (Optional), or Accessories

Observe all applicable regulations when disposing of these products.

Media Rolls

- Use Brother accessories and supplies.
- Some Media Rolls cannot be used with this printer due to their width or diameter. Be sure to check the types of compatible rolls before purchasing them.
- If the label is affixed to a wet, dirty, or oily surface, it may peel off easily. Before affixing the label, clean the surface to which the label is affixed.
- Store the Media Roll in a cool and dark place and use it soon after opening the package.
- DO NOT expose the Media Roll to direct sunlight, high temperature, high humidity, wind, or dust as it may cause labels to peel off or discolour.
- Scratching the printed surface of the label with your fingernails or metal objects, or touching the printed surface with wet hands, can cause the colour to change or fade.
- The displayed label length may differ from the actual length of the printed label.
- Depending on the location, material, and environmental conditions, labels may unpeel or become irremovable, or the colour may change or be transferred to other objects. Before applying labels, check the environmental conditions and the material.
- Small text may not be printed as clearly as it is displayed on your device's or computer's screen.
- Printed characters may differ from the ones displayed on your device's or computer's screen as it may support a resolution higher than that of the label printer.
- DO NOT use folded, wet or damp paper, otherwise a paper misfeed or a malfunction may result.
- DO NOT affix labels to people, animals, or plants. Never affix labels to public or private property without permission.
- When a label is removed after being affixed to a surface, a portion of the label may remain.
- When a label is affixed, it may be difficult to remove the label.
- DO NOT leave a Media Roll in the printer for long periods of time. When printer is left unused for a long period of time, remove the roll before storing the printer.
- Store Media Rolls in a cool, dark place, away from direct sunlight and any liquids. Keep it free from dust and dirt, as dust and dirt may increase friction during printing and shorten the life of the Print Head.

-
- Store Media Rolls with the roll core vertically. Storing them horizontally, with the label surface down, may cause quality deterioration.
 - For warnings and safety precautions, see the *Product Safety Guide*.



Related Information

- [Before You Use Your Printer](#)
-

Trademarks and Licences

- Apple, App Store, AirPrint, iPadOS, iPad, iPhone, iPod touch, and Safari are trademarks of Apple Inc., registered in the U.S. and other countries.
- Android and Google Chrome are trademarks of Google LLC.
- Google Play and the Google Play logo are trademarks of Google LLC.
- The Bluetooth® word mark and logos are registered trademarks owned by Bluetooth SIG, Inc. and any use of such marks by Brother Industries, Ltd. is under license. Other trademarks and trade names are those of their respective owners.
- QR Code is a registered trademark of DENSO WAVE INCORPORATED.
- Epson ESC/P is a registered trademark of Seiko Epson Corporation.
- Wi-Fi® is a registered trademark of Wi-Fi Alliance®.
- WPA, WPA2, WPA3, Wi-Fi Protected Setup and Wi-Fi Protected Setup logo are trademarks of Wi-Fi Alliance®.
- Mozilla and Firefox are registered trademarks of the Mozilla Foundation.
- QR Code Generating Program Copyright © 2008 DENSO WAVE INCORPORATED.
- BarStar Pro Encode Library (PDF417, Micro PDF417, DataMatrix, MaxiCode, AztecCode, GS1 Composite, GS1 Databar, Code93, MSI/Plessey, POSTNET, Intelligent Mail Barcode)
Copyright © 2007 AINIX Corporation. All rights reserved.
- Blue SDK
Copyright © OpenSynergy GmbH, 2000 - 2024.
All rights reserved. All unpublished rights reserved.
- Portions of this software are copyright © 2014 The FreeType Project (www.freetype.org). All rights reserved.
- USB Type-C® is a registered trademark of USB Implementers Forum.

Any trade names and product names of companies appearing on Brother products, related documents and any other materials are all trademarks or registered trademarks of those respective companies.



Related Information

- [Before You Use Your Printer](#)

Open Source Licensing Remarks

This product includes open source software.

To see the Open Source Licensing Remarks, go to your model's **Manuals** page on the Brother support website at support.brother.com/manuals.



Related Information

- [Before You Use Your Printer](#)
-

Important Note

- The contents of this document and the specifications of this product are subject to change without notice.
- Brother reserves the right to make changes without notice in the specifications and materials contained herein and shall not be responsible for any damages (including consequential) caused by the reliance on the materials presented, including, but not limited to, typographical and other errors relating to the publications.
- Screen images in this document may differ depending on your computer's operating system, your product model, and software version.
- Before using the printer, make sure you read all the documents included with it for information about safety and operation.
- The printer shown in the illustrations may be different from your printer.
- The available supplies may vary depending on your country or region.
- We recommend using the latest version of P-touch Editor. For the latest version, go to your model's **Downloads** page at support.brother.com/downloads.
- To keep your printer's performance up to date, visit support.brother.com/downloads to check for the latest firmware updates. Otherwise, some of your printer's functions may not be available.
- Before giving your machine to anyone else, replacing it, or disposing of it, we strongly recommend resetting it to its factory settings to remove all personal information.



Related Information

- [Before You Use Your Printer](#)
-

Set Up Your Printer

- [Parts Description](#)
- [Control Panel Overview](#)
- [LCD Overview](#)
- [LED Patterns and Indications](#)
- [Install the Rechargeable Li-ion Battery](#)
- [Charge the Rechargeable Li-ion Battery](#)
- [Turn Power On/Off](#)
- [Set the Language](#)
- [Restrict Access to Administration Menu Items](#)
- [Set the Menu Security](#)
- [Load the Roll](#)
- [Attach the Belt Clip](#)

Parts Description

>> [RJ-3235B/RJ-3255WB](#)

>> [RJ-4235B/RJ-4255WB](#)

RJ-3235B/RJ-3255WB

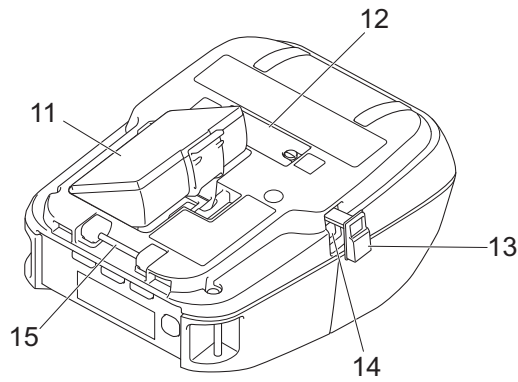
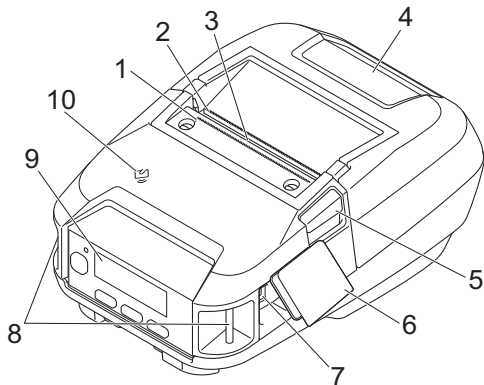

1. Upper Tear Bar
2. Lower Tear Bar
3. Paper Exit Slot
4. Roll Compartment Cover
5. Roll Cover Release Lever
6. Interface Cover
7. USB Type-C® Port
8. Shoulder Strap Slots
9. Control Panel
10. Near-Field Communication (NFC) Sensor
11. Rechargeable Li-ion Battery Compartment
12. Charging Cradle Terminal Cover
13. DC Connector Cover
14. DC Connector
15. Belt Clip Hook

RJ-4235B/RJ-4255WB

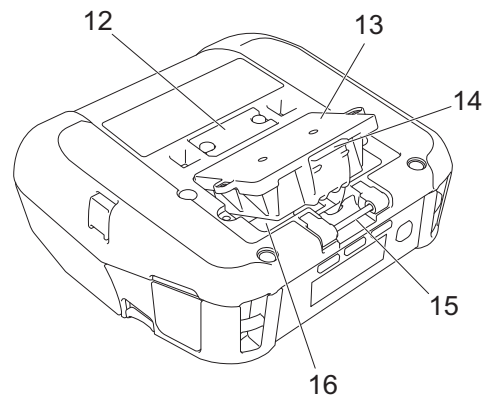
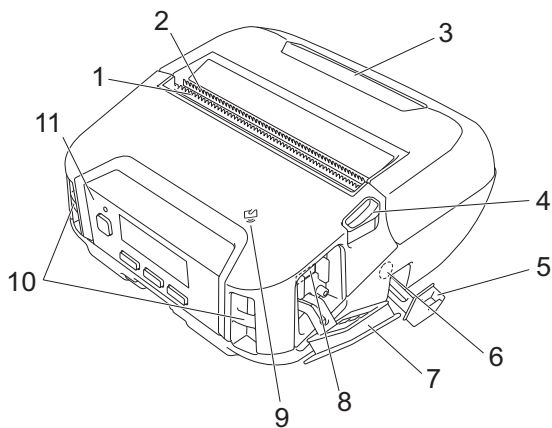

1. Upper Tear Bar
2. Lower Tear Bar
3. Roll Compartment Cover

-
4. Roll Cover Release Lever
 5. DC Connector Cover
 6. DC Connector
 7. Interface Cover
 8. USB Type-C Port
 9. Near-Field Communication (NFC) Sensor
 10. Shoulder Strap Slots
 11. Control Panel
 12. Charging Cradle Terminal Cover
 13. Rechargeable Li-ion Battery Cover ¹
 14. Rechargeable Li-ion Battery Cover Latch
 15. Belt Clip Hook
 16. Rechargeable Li-ion Battery Compartment



Related Information

- [Set Up Your Printer](#)

Related Topics:



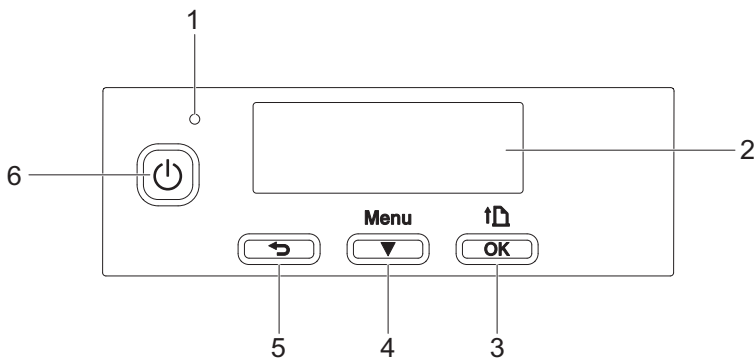

- [Control Panel Overview](#)
-

¹ For the model not include the battery

Control Panel Overview





1. LED Indicator
2. LCD
3.  (Feed) / **OK** Button

Function	Operation
Feed the paper	When the paper type is set to <i>Die-cut</i> or <i>Mark</i> : Press  to automatically feed the paper to the print position. When the paper type is set to <i>Continuous</i> : Press  to feed the paper.
Print the printer information	Make sure that a roll is set, and then press and hold  to print the printer information.
Activate the selected menu option	Press  to activate the selected menu option.

4. **Menu / ▼** (Select) Button



Function	Operation
Enter the menu selection mode	While the printer is turned on, press the Menu / ▼ (Select) button.
Select the menu option	When the menu is displayed, press the Menu / ▼ (Select) button to select the next option.
Execute a file stored in the mass storage area	If you press this button while the printer is running in mass storage mode, you can execute a command file stored in the mass storage area. For more information, see <i>Related Topics</i> .

5.  (Back) Button

Function	Operation
Clear the selected menu item and return to the previous screen.	Press the  (Back) button to return to the previous setting category.
Cancel the current print job.	Press the  (Back) button to cancel the current print job.

6.  (Power) Button

Function	Operation
Turn the printer on	While the printer is turned off, press the  (Power) button.

Function	Operation
Turn the printer off	While the printer is turned on, press the  (Power) button until the message <i>System Off</i> appears on the LCD. (If the Auto Power Off feature is enabled in the Device Settings, the printer will turn itself off automatically after the selected period of inactivity.)
Start the printer in mass storage mode	If you press and hold the  (Power) button while also pressing the Menu / ▼ (Select) button, the printer starts in mass storage mode. For more information, see <i>Related Topics</i> .



Related Information

- [Set Up Your Printer](#)

Related Topics:

- [LCD Overview](#)
 - [LED Patterns and Indications](#)
 - [Print Using the USB Interface \(Mass Storage Mode\)](#)
-

LCD Overview

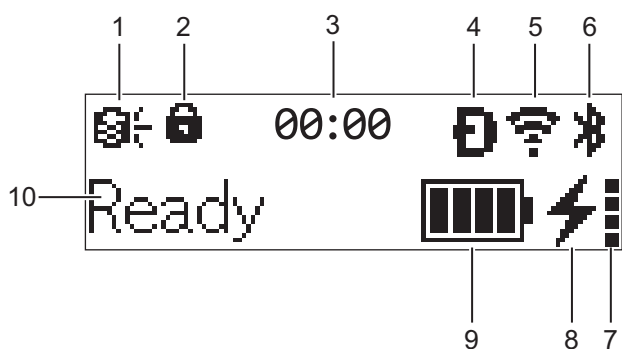

- Update (RJ-3235B/RJ-3255WB/RJ-4255WB)**
Indicates the FTP connectivity and update status.

	There is new data.
 (flashing)	Data update is unsuccessful.
 (flashing)	Cannot connect to the server.

Remote Update(RJ-3235B/RJ-3255WB/RJ-4255WB)

The Remote Update feature allows semi-automatic updating of printer settings by connecting to a network folder that contains the necessary update files.

Prepare for a remote update:

Open the BRConfiguration Tool on your computer and configure the settings in the **Communication settings** menu.

Perform a remote update from your printer:

- Press the **Menu / ▼** (Select) button to select the [Update] menu, and then press the (Feed) / **OK** button.
- Select [Start], and then press the (Feed) / **OK** button again.

During the update, the LCD will display the message [Receiving] or [Downloading].

For more information on how to update data, visit the Brother support website at support.brother.com.





- Menu Key Lock**
Displays when the **Menu Key Function** in BRConfiguration Tool is set to **Disable**.
- Clock**
Displays when [Clock] is set to [On].
- Wireless Direct (RJ-3255WB/RJ-4255WB)**
Indicates if Wireless Direct is available.
- WLAN (RJ-3255WB/RJ-4255WB)**

	Your printer is connected to the wireless network.
	Your printer is searching for a wireless network.

- Bluetooth®/MD**
Indicates if Bluetooth is on. When the icon is flashing, the printer is automatically re-pairing. For more information, see *Related Topics*.



7. Battery health level

The Battery health level icon does not appear when charging is not possible.

Message	Icon	Condition
BatteryHealth Excellent		No problems. The rechargeable Li-ion battery may be used.
BatteryHealth Good		Still healthy. The rechargeable Li-ion battery can be used.
Battery Poor Replace soon		The rechargeable Li-ion battery health is deteriorating.
Batt.VeryPoor Replace battery		The rechargeable Li-ion battery is badly deteriorated.





8. Charge status

Displays the charge status of the rechargeable Li-ion battery.

	Charging
	Not Charging (The rechargeable Li-ion battery cannot be charged if its temperature is above 40°C or below 0°C.)
No icon	Charging is finished or paused

9. Battery level

Indicates the remaining battery level.

	Full
	High
	Half
	Low

10. Printer status

Displays the printer status.

















Related Information





- [Set Up Your Printer](#)

LED Patterns and Indications

The indicator lights and flashes to indicate the printer's status. The symbols used in this section explain the meaning of the different indicator colours and patterns:

 or  or 	Indicator is lit in the colour shown.
 or  or 	Indicator is flashing in the colour shown.
	Indicator is off.

LED Indicator	Status
	Power off
	Charging complete (when power is turned off)
	Not charging (when power is turned off)
	Battery level: Half or more
	Charging complete (when power is turned on)
	Power on
	Not charging (when power is turned on)
	Charging
	Boot mode
	 If the indicator is lit in red (Boot mode), contact Brother customer service.
 (Flashing rapidly every two seconds)	Battery level: low
	Sleep mode
	Roll end error
	Feed error
	Cover open error
	Communication error
	WPS connection error
	BLF file error
	No template error
	Memory full error
	ESC/P Memory full error
	JPEG file error
	Battery deterioration error
	Mass storage error
	Battery level: empty
	System error
	Database search error
Battery error (if the rechargeable Li-ion battery is not fully charged after the specified amount of time)	

LED Indicator	Status
	Set clock error
	Remaining battery error
 →  →  (RJ-3235B/RJ-3255WB)	The peeler function cannot be used due to strong ambient light.



Related Information

- [Set Up Your Printer](#)
-

Install the Rechargeable Li-ion Battery

Make sure you charge the Rechargeable Li-ion battery (PA-BT-006) either in the printer or on the battery charger before initial use.

>> [RJ-3235B/RJ-3255WB/RJ-4235B-L \(with battery\)/RJ-4255WB-L \(with battery\)](#)

>> [RJ-4235B/RJ-4255WB](#)

RJ-3235B/RJ-3255WB/RJ-4235B-L (with battery)/RJ-4255WB-L (with battery)

1. Unlock the rechargeable Li-ion battery, and then remove it.

RJ-3235B/RJ-3255WB

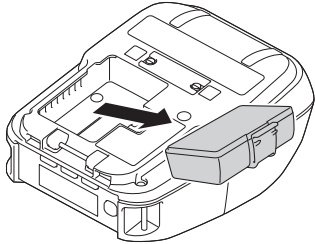

RJ-4235B-L/RJ-4255WB-L

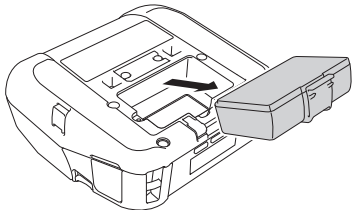

2. Remove the insulating sheet.

RJ-3235B/RJ-3255WB

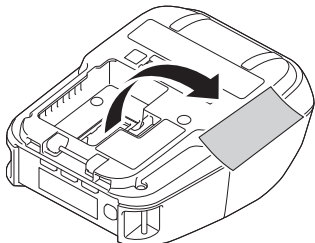

RJ-4235B-L/RJ-4255WB-L

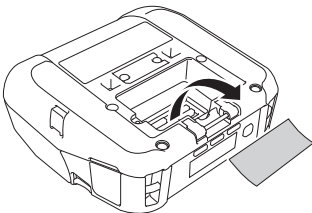

3. Insert the rechargeable Li-ion battery until it locks into place.

RJ-3235B/RJ-3255WB

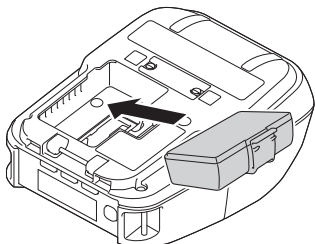

RJ-4235B-L/RJ-4255WB-L

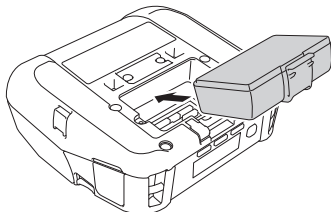

RJ-4235B/RJ-4255WB

1. Unlock and remove the rechargeable Li-ion battery cover.

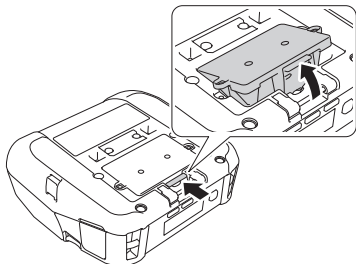

2. Insert the rechargeable Li-ion battery until it locks into place.

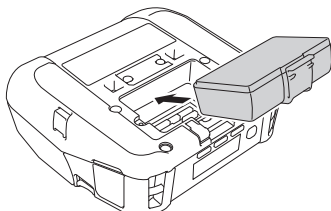

- To remove the rechargeable Li-ion battery, reverse the installation procedure.
- Do not lose the rechargeable Li-ion battery cover as you will need to reattach it later.

✓ Related Information

- [Set Up Your Printer](#)

Charge the Rechargeable Li-ion Battery

- >> [Tips on Using the Rechargeable Li-ion Battery](#)
- >> [Charge the Rechargeable Li-ion Battery Using a USB Cable](#)
- >> [Charge the Rechargeable Li-ion Battery Using an AC Adapter \(Optional\)](#)
- >> [Charge the Rechargeable Li-ion Battery Using a Car Adapter \(Optional\)](#)
- >> [Charge the Rechargeable Li-ion Battery Using the Battery Charger \(Optional\) or the Charging Cradle \(Optional\)](#)
- >> [When not Using the Rechargeable Li-ion Battery \(RJ-4235B/RJ-4255WB\)](#)
- >> [Stop Charging the Rechargeable Li-ion Battery](#)

Tips on Using the Rechargeable Li-ion Battery

Fully charge the rechargeable Li-ion battery before using the printer.



- High-density (dark) printing discharges the rechargeable Li-ion battery faster than low-density printing. Adjust the print density setting in the Device Settings. For more information, see *Related Topics*.
- The rechargeable Li-ion battery charging must take place in an environment with a temperature between 0°C and 40°C, otherwise the rechargeable Li-ion battery will not be charged. If the charging stops because the environment temperature is too low or too high, place the printer in an environment with a temperature between 0°C and 40°C and try charging again.
- The recommended charging temperature range for the rechargeable Li-ion battery is from 5°C to 35°C.
- If you use the printer when both the rechargeable Li-ion battery is installed and the AC Adapter or Car Adapter is connected, charging may stop even if the rechargeable Li-ion battery is not fully charged.

Rechargeable Li-ion Battery Characteristics

To ensure the highest performance and longest life from the rechargeable Li-ion battery:

- Do not use or store the rechargeable Li-ion battery in a location exposed to extreme high or low temperatures as it may deteriorate more quickly.
- Remove the rechargeable Li-ion battery when storing the printer for long periods of time.
- Store rechargeable Li-ion batteries with less than a 50% charge in a cool dry place and out of direct sunlight.
- Recharge the rechargeable Li-ion battery every six months if it is stored for long periods of time.
- It is normal and safe for the printer to become warm while charging. Disconnect the charger and stop using the printer if it becomes hot to the touch.
- When the printer is turned on, the rechargeable Li-ion battery health status appears on the LCD.
For the battery health level indication, see *Related Topics*.

Charge the Rechargeable Li-ion Battery Using a USB Cable



- The USB Type-C cable is not included.
 - Compatible USB cable: USB Type-C to USB Type-C (5 V, 1.5 A or more)
 - Compatible USB charger: USB Type-C (5 V, 1.5 A or more)

1. Make sure that the rechargeable Li-ion battery is installed in the printer.
2. Open the USB Port Cover.
3. Connect the USB cable to the USB port on the printer, and then either to your computer or to a compatible USB charger.

Charge the Rechargeable Li-ion Battery Using an AC Adapter (Optional)

When purchasing the printer, purchase the correct AC Adapter and AC power cord for the region where the printer will be used.



The AC Adapter and AC power cord are optional accessories.

1. Make sure that the rechargeable Li-ion battery is installed in the printer.
2. Open the DC Connector Cover and connect the AC Adapter (PA-AD-600A) to the printer.
3. Connect the AC power cord to the AC Adapter.
4. Connect the AC power cord to a nearby electrical socket (100 V AC - 240 V AC, 50/60 Hz).

RJ-3235B/RJ-3255WB

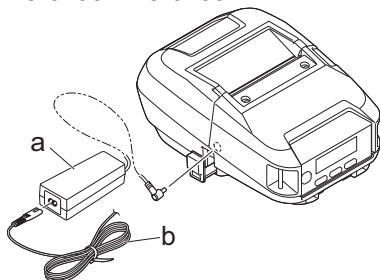

- a. AC Adapter
- b. AC power cord

RJ-4235B/RJ-4255WB

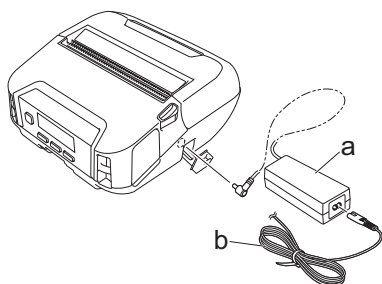

- a. AC Adapter
- b. AC power cord

Charge the Rechargeable Li-ion Battery Using a Car Adapter (Optional)

Connect the printer to your vehicle's 12 V DC power socket (cigarette lighter or similar) to charge the rechargeable Li-ion battery.



The Car Adapter is an optional accessory.

1. Make sure that the rechargeable Li-ion battery is installed in the printer.
2. RJ-3235B/RJ-3255WB: Connect the Car Adapter (PA-CD-600CG) to the vehicle's 12 V DC power socket.
3. RJ-4235B/RJ-4255WB: Connect the Car Adapter (PA-CD-600CG, PA-CD-600WR) to the vehicle's 12 V DC power socket.

4. Open the DC Connector Cover and connect the Car Adapter to the printer.

RJ-3235B/RJ-3255WB

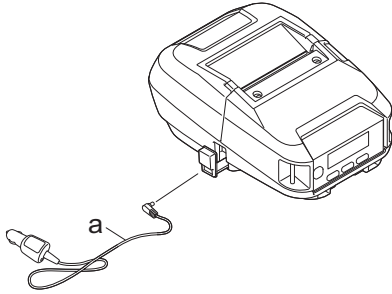

a. Car Adapter

RJ-4235B/RJ-4255WB

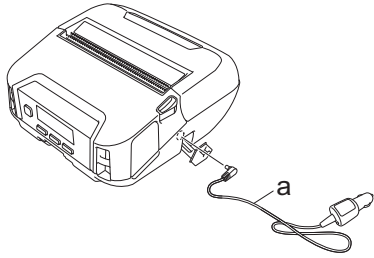

a. Car Adapter

Charge the Rechargeable Li-ion Battery Using the Battery Charger (Optional) or the Charging Cradle (Optional)

The rechargeable Li-ion battery can be charged using the Battery Charger (Optional) or the Charging Cradle (Optional). For more information, see *Related Topics*.

When not Using the Rechargeable Li-ion Battery (RJ-4235B/RJ-4255WB)

The printer may be operated without the rechargeable Li-ion battery in the following ways:

- When an AC Adapter (PA-AD-600A) or Car Adapter (PA-CD-600CG) is connected to the printer.
- When the printer is installed in the Charging Cradle (PA-CR-002A).



When the rechargeable Li-ion battery is not installed, securely fasten the rechargeable Li-ion battery cover with self-tapping screws (M2.6 x 6mm) (not included).

Stop Charging the Rechargeable Li-ion Battery

To stop the rechargeable Li-ion battery charging, disconnect the printer from the computer or power source.



✓ Related Information

- [Set Up Your Printer](#)

Related Topics:

- [LCD Overview](#)
- [Charging Cradle \(Optional: PA-CR-005\)](#)
- [4-bay Charging Cradle \(Optional: PA-4CR-003\)](#)
- [Battery Charger \(Optional: PA-BC-003\)](#)

Turn Power On/Off

- To turn the printer on, press .
The Power LED lights in green.
- To turn the printer off, press  until the message [System Off] appears on the LCD.

NOTE





- When the printer is connected to the AC Adapter, it turns on automatically by default.
- Do not remove the rechargeable Li-ion battery until the LCD turns off when the AC Adapter is not connected to the printer and the electrical socket.



Related Information

- [Set Up Your Printer](#)
-

Set the Language

1. Press the **Menu / ▼** (Select) button to select the [Settings] menu, and then press the  (Feed) / **OK** button.
2. Select  [Language], and then press the  (Feed) / **OK** button.
3. Select a language, and then press the  (Feed) / **OK** button.



Related Information

- [Set Up Your Printer](#)
-

Restrict Access to Administration Menu Items

Access restrictions can be set for every item in the Administration Menu.

1. Press **Menu**.
2. Press **▲** or **▼** to select the following:
 - a. Select [Admin Menu]. Press **OK**.
 - b. Select [Menu Lock]. Press **OK**.
3. Press **▲**, **▼**, or **OK** to select the menu items you want.
4. Press **▲** or **▼** to select [Finish], and then press **OK** to complete the settings.



Related Information

- [Set Up Your Printer](#)
-

Set the Menu Security

When setting the menu security, access to the Administration mode can be restricted by setting a passcode.

1. Press **Menu**.
 2. Press **▲** or **▼** to select the following:
 - a. Select [Admin Menu]. Press **OK**.
 - b. Select [Menu Security]. Press **OK**.
 3. Press **▲** or **▼** to select [On]. Press **OK**.
 4. Press **▲** or **▼** to specify the first number, and then press **OK** to proceed to the next number.
Repeat this step to specify the remaining three numbers.
- If a passcode has been set, the passcode input screen appears whenever the [Admin Menu] menu is selected. Press **▲** or **▼** to enter the specified four-digit passcode, and then press **OK**.
 - To cancel the passcode settings, select the [Admin Menu] menu and enter the passcode. Then, select [Menu Security] > [Off].
 - If you do not remember the passcode, use the BRConfiguration Tool to return all settings to their factory values or set the passcode again.



Related Information

- [Set Up Your Printer](#)

Load the Roll

- >> Load the Roll
- >> Paper with a Black Mark from the Left End to the Right End (Recommended)
- >> Paper with a Black Mark on the Detection Range of the Reflective/Black Mark Sensor
- >> Change the Media Roll Holders to Use Custom-Size Media
- >> Tear-Off Media

Load the Roll

1. Push the Roll Cover Release Lever to open the Roll Compartment Cover.

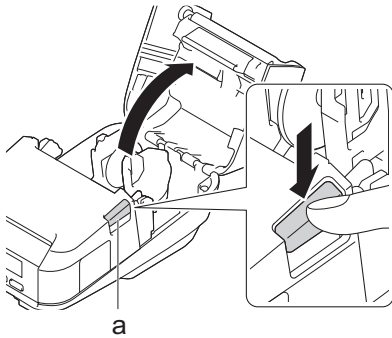

a. Roll Cover Release Lever

2. Slide both Roll Guides outwards.

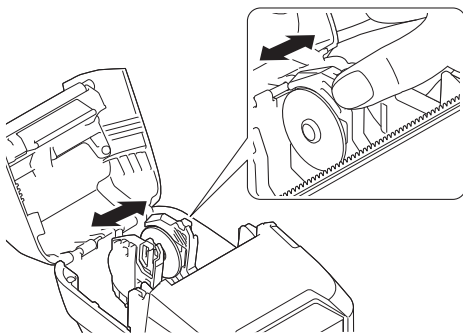

3. Make sure that the roll is correctly aligned, and then insert it into the Roll Compartment.

NOTE

If the core of the roll is protruding, flatten the edges before setting, as illustrated.

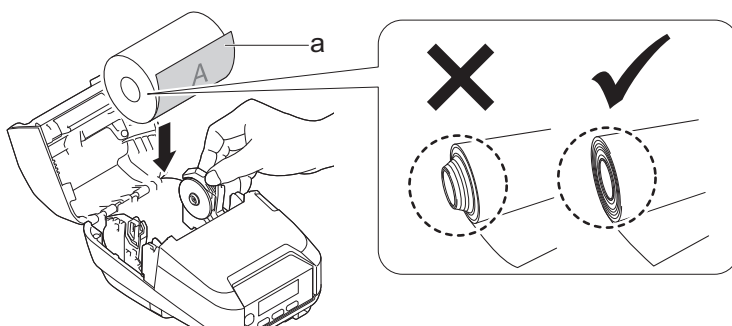

a. Print surface (faces outwards on the roll)

4. Close the Roll Compartment Cover until it locks into place.

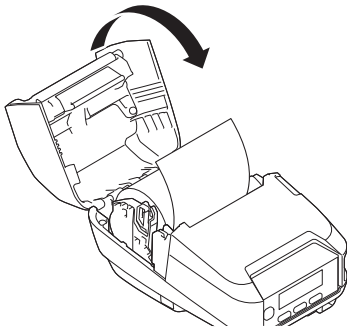

5. If the LCD shows [Select Media] or [Auto Detect], select the option you want. To configure these settings later, go to the [Media].

NOTE

- For best performance, use genuine Brother media.
- To allow the reflective/black mark sensor to detect the mark and feed the media to the correct position, use paper with a black mark on the detection range of the sensor.
- Use paper that meets any of the following conditions so that the reflective/black mark sensor can detect the mark correctly.



- When using die-cut labels, set the paper type to **Die-cut Label**, and press the  (Feed) / **OK** button after inserting the roll. The printer will feed the label to the top of form position.
- To remove the roll, reverse the loading procedure.
- Make sure the inserted roll turns freely between the Roll Guides.

Paper with a Black Mark from the Left End to the Right End (Recommended)

Use paper that meets the conditions described in the illustration below.

Although the detection range of the reflective/black mark sensor differs depending on the printer model being used, the black mark described in the illustration is long enough to cover the detection range of the sensor regardless of models.

- **Media without any fold lines like perforations**

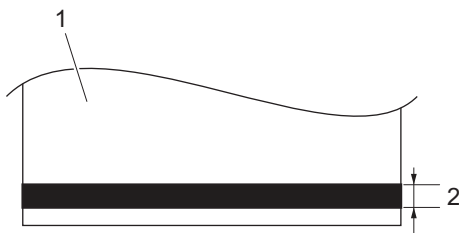

1. Back of media
2. 3 mm or more

- **Media with fold lines like perforations**

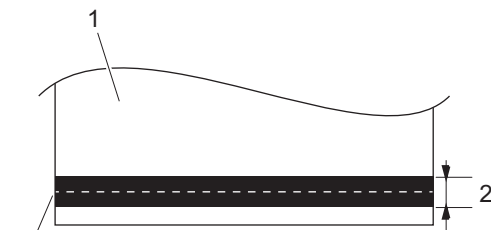

1. Back of media

2. 4 mm or more
3. Flod lines like perforations

Paper with a Black Mark on the Detection Range of the Reflective/Black Mark Sensor

Use paper that meets the conditions described in the illustration below.

Since the detection range of the reflective/black mark sensor differs depending on the printer model being used, the appropriate length of the black mark also differs by models.

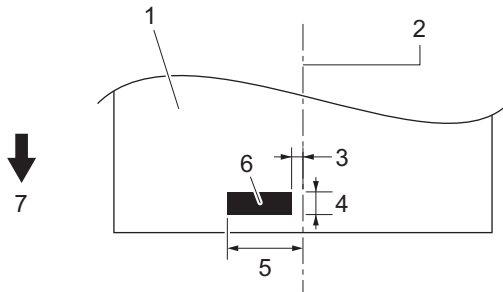

1. Back of media
2. Centreline of media
3. 1.5 mm or below
4. 3 mm or more
(Media with fold lines like perforations: 4 mm or more)
5. 10 mm or more
6. Black mark
7. Feed direction

Change the Media Roll Holders to Use Custom-Size Media

Your product is pre-installed with two Media Roll Holders and the core diameter is as follows:

- RJ-3235B/RJ-3255WB: 25.4 mm
- RJ-4235B/RJ-4255WB: 25.4 mm

To use custom-size media, attach the Media Roll Holders that match your media's core size to the Roll Guides.

NOTE

- A set of two Media Roll Holders is included with your machine. The core diameters of two Media Roll Holders as follows:
 - RJ-3235B/RJ-3255WB: 12.7 mm-13.0 mm/19.0 mm
 - RJ-4235B/RJ-4255WB: 12.7 mm-13.0 mm/19.0 mm
- Not all types of Media Roll Holders may be supplied with your printer. To purchase additional Media Roll Holders, contact your local Brother dealer.
- To check which media core sizes each Media Roll Holder supports, check the information on the centre of the Media Roll Holder.
- If using multi-size Media Roll Holders, make sure the same-size sides face each other when attached to the Roll Guides.

1. Push the Roll Cover Release Lever to open the Roll Compartment Cover.

2. Hold the left Roll Guide so that it does not rotate, and then remove the currently installed Media Roll Holder using a Phillips screwdriver.

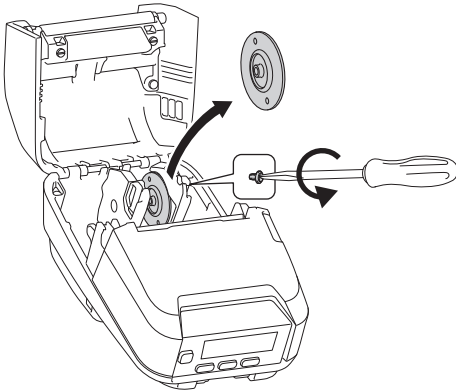

3. Hold the right Roll Guide so that it does not rotate, and then remove the currently installed Media Roll Holder using a Phillips screwdriver.
4. Attach the Media Roll Holders that match your media's core size to the Roll Guides using a Phillips screwdriver. Make sure you use the same size Media Roll Holders.

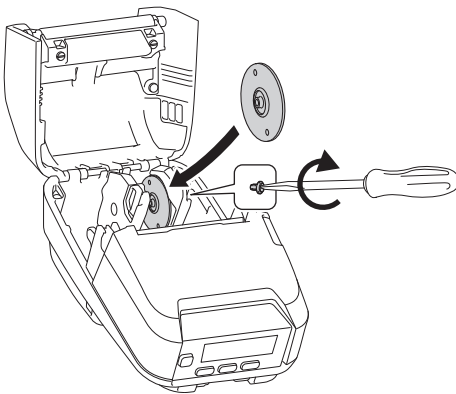

5. Insert the roll. For more information, , see *Related Topics*..
6. Close the Roll Compartment Cover and press until it locks into place.
7. If the LCD automatically shows [Select Media] or [Auto Detect], select the option you want. To configure these settings later, go to the [Media] menu

Tear-Off Media

Receipt paper, labels, and tags can be torn off by swiftly pulling up or down on the media according to the set cutting position. Linerless media can only be torn upwards.

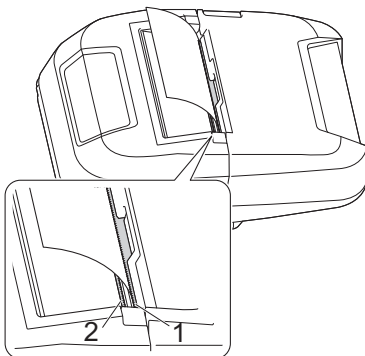

1. Upper Tear Bar
2. Lower Tear Bar

CAUTION

Do not touch the Tear Bar blade.



- The default [Tear Bar] setting is set to [Upward]. (When **Linerless** is set to **On** in the **Advanced** tab of the BRConfiguration Tool, the [Tear Bar] setting is not available.)
 - To adjust the cutting position, open the BRConfiguration Tool, go to **Print Position / Sensors** in the **Device Settings**, and then enter the setting you want in the **Tear Adjust** field. For more information, see *Related Topics*.
-



Related Information

- [Set Up Your Printer](#)
-

Attach the Belt Clip

1. Attach the Belt Clip to the Belt Clip Hook on the printer, as shown:

RJ-3235B/RJ-3255WB

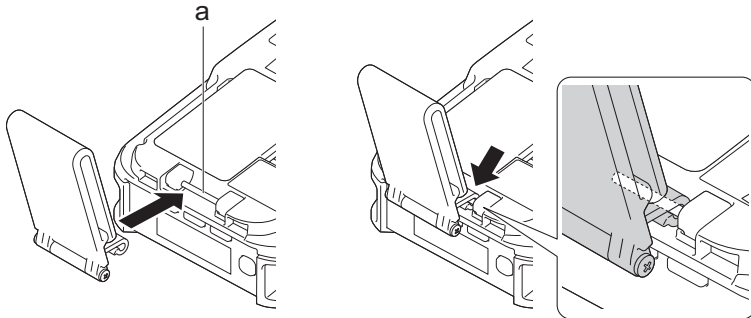

a. Belt Clip Hook

RJ-4235B/RJ-4255WB

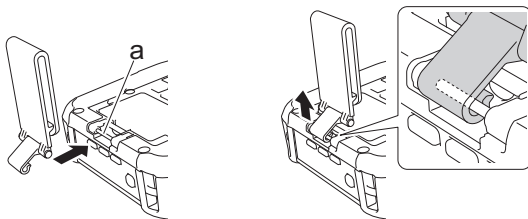

a. Belt Clip Hook

2. Attach the Belt Clip to your belt, as illustrated.

RJ-3235B/RJ-3255WB

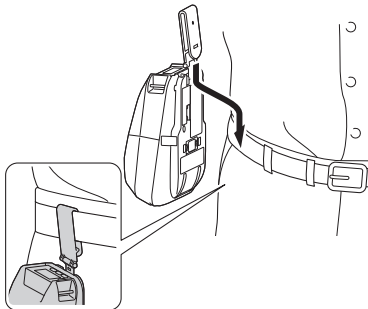

RJ-4235B/RJ-4255WB

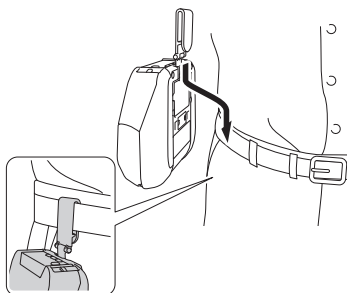

- Make sure you attach the Belt Clip securely to the printer.
- To detach the Belt Clip, reverse the installation procedure.
- We recommend using a belt that is less than 5 mm thick and less than 47.63 mm wide.



Related Information

- [Set Up Your Printer](#)

Install Software

- [Install Printer Drivers and Software on a Computer](#)
- [Connect the Printer to a Computer or Mobile Device](#)

Install Printer Drivers and Software on a Computer

To print from your computer, install the printer driver and any additional software on your computer. See *Related Information: Available Applications*.

1. In the address bar, type install.brother and download the Software/Documentation installer.

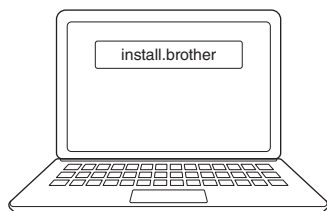

2. Double-click the downloaded installer, and follow the on-screen instructions.

NOTE

To use your printer's advanced features, select the additional software you want during installation.



- RJ-3255WB/RJ-4255WB:

To connect the printer to a computer using a wireless connection, we recommend the following:

- Write down your wireless network's SSID (Network Name) and Password (Network Key) before you begin. If you cannot find this information, contact your network administrator or wireless router/access point manufacturer.
- To connect the printer to a computer using Wireless Direct, select "USB connection" during installation. When installation finishes, click the Wireless Direct link.
- To use the printer with a different connection method than the one you selected during installation, run the installer again, reinstall the software and printer drivers, and select a different connection method.



Related Information

- [Install Software](#)
 - [Available Applications](#)

Available Applications



These applications are available only for Windows.

Application	Features
P-touch Editor	Allows you to design and print custom labels using built-in drawing tools to create various font and text styles, and to import images and insert barcodes.
P-touch Update Software	Confirm and update software and firmware to the latest version.
BRConfiguration Tool	Allows you to configure the printer's settings from a computer.
BRAdmin Professional (RJ-3235B/ RJ-3255WB/ RJ-4255WB)	Finds the printer on your network and allows you to configure basic settings and updates from your computer.
Font Manager	<p>Allows you to transfer fonts to the printer and delete fonts from the printer. Transferred fonts can be accessed and printed using various print commands.</p> <p>To download the installer, go to your model's Downloads page on the Brother support website at support.brother.com.</p> <hr/> <p> Font Permissions</p> <p>When using fonts, you must abide by all the terms and conditions set forth by each rightful font owner. Before downloading fonts, you must confirm that you have legitimate licences to use the fonts and comply with their terms and conditions; otherwise you may not download fonts.</p> <hr/>
Web Based Management	Allows you to use a standard web browser to manage a printer on your network using HTTPS.
LabelCLT (Command Line Tool)	<p>Allows you to transfer firmware to a USB-connected or networked printer. Templates and configuration files saved by each tool can be transferred to the printer.</p> <p>To download LabelCLT, go to your model's Downloads page on the Brother support website at support.brother.com.</p>



Related Information

- [Install Printer Drivers and Software on a Computer](#)

Related Topics:

- [Compatible Printing Apps](#)

Connect the Printer to a Computer or Mobile Device

- [Connect Using a USB Cable](#)
- [Connect Using Wi-Fi](#)
- [Connect Using Bluetooth Connection](#)
- [Connect the Printer to a Mobile Device Using NFC \(Android\)](#)

Connect Using a USB Cable

The USB Type-C cable is not included.

1. Turn the printer off.
2. Connect the USB cable to the USB port (USB Type-C) on the printer, and then to your computer.

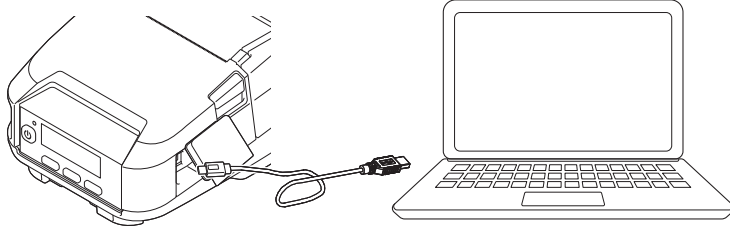

3. Turn the printer on.



Related Information

- [Connect the Printer to a Computer or Mobile Device](#)

Connect Using Wi-Fi

Related Models: RJ-3255WB/RJ-4255WB

The following Wi-Fi connection methods are available:





- >> [Using a Wi-Fi Router/Access Point \(Infrastructure Mode\)](#)
- >> [Without Using a Wi-Fi Router/Access Point \(Wireless Direct\)](#)
- >> [Using Infrastructure Mode and Wireless Direct Simultaneously](#)
- >> [Using WPS \(Wi-Fi Protected Setup™\)](#)

Using a Wi-Fi Router/Access Point (Infrastructure Mode)





Infrastructure Mode allows you to connect the printer to a computer or mobile device via Wi-Fi router/access point.

• Before You Begin

First you must configure the printer's Wi-Fi settings to communicate with your Wi-Fi router/access point. After the printer is configured, the computers and mobile devices on your network will have access to the printer.

- Before connecting the printer to your network, contact your system administrator to confirm your Wi-Fi network settings.
- To reconfigure the Wi-Fi settings, or if the status of the printer's Wi-Fi connection is unknown, reset the printer's Wi-Fi settings.
 1. Press and hold the  (Feed) / **OK** button and the  (Power) button for about five seconds. The LED indicator starts flashing green.
 2. While pressing the  (Power) button, press the  (Feed) / **OK** button twice.
 3. Release the  (Power) button.
- To achieve the best results with normal everyday printing, use the printer as close to the Wi-Fi router/access point as possible with minimal obstructions. Large objects and walls between the two devices as well as interference from other electronic devices can affect the transfer speed of print data.

• Connect the printer to your Wi-Fi router/access point

1. First, write down your Wi-Fi router/access point's SSID (Network Name) and Password (Network Key).
2. Connect the printer and computer using a USB cable.
3. On the printer, press the **Menu / ▼** (Select) button to select the [WLAN] menu, and then press the  (Feed) / **OK** button again to set [On/Off] to [On].
4. You can configure the printer's Infrastructure Mode using one of the methods below.
 - Using the printer's LCD and a Windows computer:
 - a. Press the **Menu / ▼** (Select) button to select the [WLAN] menu, and then press the  (Feed) / **OK** button.
 - b. Press the **Menu / ▼** (Select) button to select the [Mode] menu, and then press the  (Feed) / **OK** button.
 - c. Select the [Infrastructure] option, and then press the  (Feed) / **OK** button.
 - d. Start the BRConfiguration Tool on your computer and click the **Edit device settings** option.
 - e. Select the **Communication settings** menu, and then go to the **Wireless LAN** tab.
 - f. Enter the SSID that you wrote down, or click **Search** and select the SSID from the displayed list.
 - Using a Windows computer:
 - a. Start the BRConfiguration Tool on your computer, and click the **Edit device settings** option.

- b. Select the **Communication settings** menu, go to the **Wireless LAN** tab, and select the **Infrastructure** option from the **Selected Interface** drop-down list.
 - c. Enter the SSID that you wrote down, or click **Search** and select the SSID from the displayed list.
5. Enter the password as **Passphrase**.

NOTE

The information required during this process depends on the authentication method and encryption mode.

6. Click **Apply**.





When the connection between the printer and your Wi-Fi router/access point is established, the  (Wi-Fi) icon appears on the printer's LCD. Computers and mobile devices that are on the same network as the printer will have access to the printer.



To change any other network settings, use the BRConfiguration Tool.

Without Using a Wi-Fi Router/Access Point (Wireless Direct)



Wireless Direct allows you to connect the printer to your computer or mobile device directly, without a Wi-Fi router/access point. The printer serves as a Wi-Fi access point.

1. Confirm the Wireless Direct settings of the printer.
 - From the LCD menu:
 - a. Press the **Menu / ▼** (Select) button to select the [WLAN] menu, and then press the  (Feed) / **OK** button.
 - b. Press the **Menu / ▼** (Select) button to select the [Mode] menu, and then press the  (Feed) / **OK** button.
 - c. Select [Direct], and then press the  (Feed) / **OK** button.
 - Using a Windows computer:
 - a. Connect the printer and computer using a USB cable.
 - b. Start the BRConfiguration Tool on your computer, and click the **Edit device settings** option and go to **Communication settings** menu.
 - c. Confirm that **Wireless Direct** is selected for **Network mode** in the **Wireless LAN** tab.
2. On the printer, press the **Menu / ▼** (Select) button to select the [WLAN] menu, and then press the  (Feed) / **OK** button. Set [On/Off] to [On]. The Wireless Direct icon appears on the LCD.
3. Use your computer or mobile device to select the SSID of the printer ("DIRECT*****_RJ-3255WB" or "DIRECT*****_RJ-4255WB"). If required, enter the Password (The password is located on the base of the machine and marked "WDP").

NOTE

- "DIRECT*****_RJ-", where ***** is the last five digits of the printer's serial number.
- WDP (Wired Direct Password) and the serial number are located on the base of the printer. For more information, see *Related Topics*.
- Use the BRConfiguration Tool to change the printer's network settings.
- The BRConfiguration Tool also allows you to apply the network settings to multiple printers.
- You cannot connect to the Internet via Wi-Fi while using Wireless Direct. To use the Internet, connect using a Wi-Fi router/access point (Infrastructure Mode).
- We recommend setting a new Wireless Direct password using the BRConfiguration Tool to protect your printer from unauthorised access.

Using Infrastructure Mode and Wireless Direct Simultaneously



1. Set the printer to Infrastructure Mode and Wireless Direct.
 - From the LCD menu:
 - a. Press the **Menu / ▼** (Select) button to select the [WLAN] menu, and then press the  (Feed) / **OK** button.
 - b. Press the **Menu / ▼** (Select) button to select the [Mode] menu, and then press the  (Feed) / **OK** button.
 - c. Select [Direct/Infra], and then press the  (Feed) / **OK** button.
 - Using a Windows computer:
 - a. Start the BRConfiguration Tool on your computer, and click the **Edit device settings** option.
 - b. Select **Communication settings** menu and go to **Wireless LAN** tab.
 - c. Confirm that the **Infrastructure/Wireless Direct** option is selected for the **Network mode** setting.

Using WPS (Wi-Fi Protected Setup™)

1. First, confirm that your Wi-Fi router/access point has the WPS symbol.



2. Place the printer within the range of your Wi-Fi router/access point.

The range may differ depending on your environment. See the instructions provided with your Wi-Fi router/access point.
3. Press the WPS button on your Wi-Fi router/access point.
4. On the printer, press the **Menu / ▼** (Select) button to select the [WLAN] menu, and then press the  (Feed) / **OK** button.
5. Press the **Menu / ▼** (Select) button to select the [WPS] menu, and then press the  (Feed) / **OK** button.
6. Select [Button Push] or [PIN Code] menu, and then press the  (Feed) / **OK** button.

For more information, see the instructions provided with your Wi-Fi router/access point. When the connection is established, the WLAN icon appears on the printer's LCD. Computers and mobile devices that are on the same network as the printer will have access to the printer.



- The printer will try to connect using WPS for two minutes. If the **Menu / ▼** (Select) button is pressed during that time, the printer will continue trying to connect for an additional two minutes.
- If your computer or mobile device supports the PIN authentication method, select [PIN Code] for better security.

✓ Related Information

- [Connect the Printer to a Computer or Mobile Device](#)

Related Topics:



- [Change Printer Settings Using the BRConfiguration Tool \(Windows\)](#)
- [Confirm Printer Settings](#)

Connect Using Bluetooth Connection

Follow the manufacturer's recommendations for your Bluetooth-equipped devices (computers and mobile devices) or Bluetooth adapter, and install any necessary hardware and software.

NOTE

- You can also change the printer's communication settings using the BRConfiguration Tool. For more information, see *Related Information*.
- We recommend setting a new Bluetooth PIN code using the BRConfiguration Tool to protect your printer from unauthorised access.

1. Press the **Menu / ▼** (Select) button to select the [Bluetooth] menu, and then press the  (Feed) / **OK** button.
2. Select the [On/Off] menu, and then press the  (Feed) / **OK** button. Select [On].
3. Use your Bluetooth management software to discover the printer.
Select the printer name (where XXXX is the last four digits of the printer's serial number). You can find the serial number label on the base of the printer.
When the passcode appears on the LCD while connecting, check that it is the same as that of the computer or mobile device, and then press the **OK** button.
Bluetooth communication is now available.

NOTE

By default, Bluetooth mode is set to [Classic & LE], so two identical Bluetooth names (for Classic and Low Energy) may appear in your Android device's Bluetooth menu.



Related Information

- [Connect the Printer to a Computer or Mobile Device](#)

Connect the Printer to a Mobile Device Using NFC (Android)

The default pairing settings will vary depending on your model and region.

1. Confirm that the printer's Bluetooth settings and the mobile device's Bluetooth and NFC settings are enabled.
2. Touch your mobile device to the NFC symbol on printer.

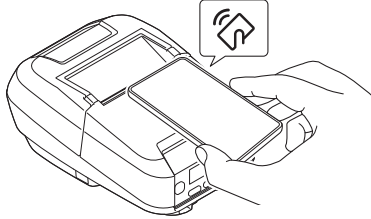

- The printer's Bluetooth mode must be set to [Classic & LE], [Classic], or [Low Energy].
- Not all Android devices may connect to your printer successfully. Check with your mobile device's User's Guide for more information.



Related Information

- [Connect the Printer to a Computer or Mobile Device](#)

Create and Print Labels Using Your Computer

- [Create and Print Labels Using P-touch Editor \(Windows\)](#)
- [Tips for Better Printing Results When Using P-touch Editor](#)
- [Create Labels and Print without Installing Software and Drivers](#)
- [Print Labels Using the Printer Driver \(Windows\)](#)

Create and Print Labels Using P-touch Editor (Windows)

To use your printer with your Windows computer, install your model's printer driver and P-touch Editor on your computer.

For the latest drivers and software, go to your model's **Downloads** page at support.brother.com/downloads.

1. Start P-touch Editor .

Click **Start > Brother P-touch > P-touch Editor**, or double-click the **P-touch Editor** icon on the desktop.

NOTE

Depending on your computer's operating system, the Brother P-touch folder may or may not be created.

2. Make sure your model's name is selected on the Home screen.
3. Do one of the following:
 - To create a new layout, click the **New Label** tab, and then click the **New Label** button (1).
 - To create a new layout using a preset layout, click the **New Label** tab, and then click a category button (2), select a template, and then click **Create** (3).
 - To open an existing layout, click **Open** (4).

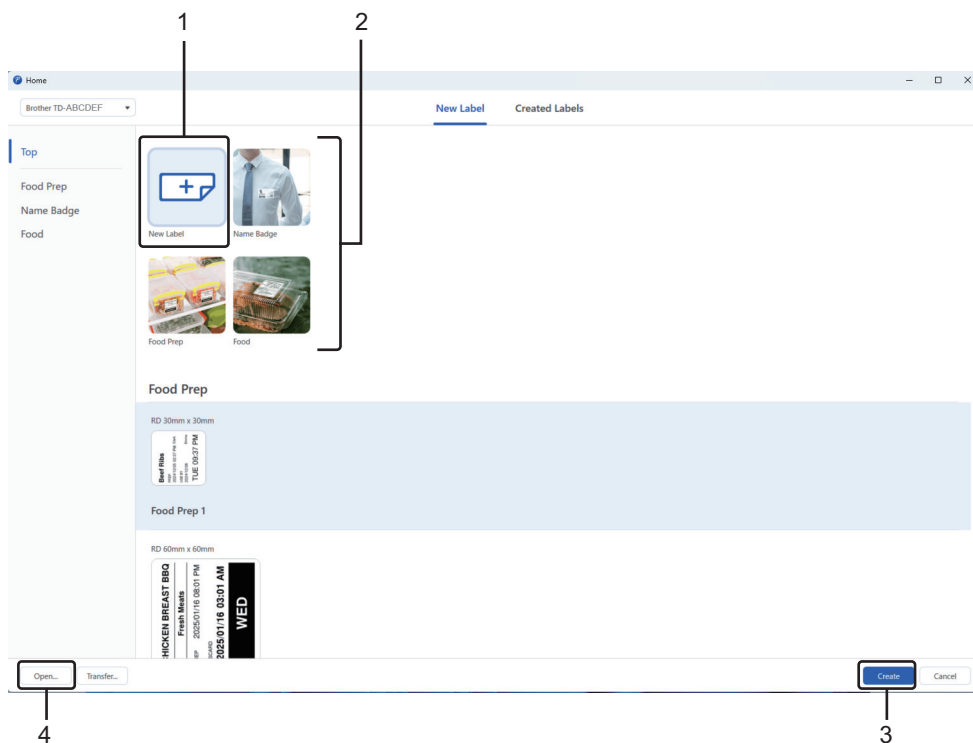

4. Click the **Print** icon.
5. Select the print settings you want, and then click **Print**.



Related Information

- [Create and Print Labels Using Your Computer](#)

Tips for Better Printing Results When Using P-touch Editor

1. Font Substitution

When creating a label template in P-touch Editor, if you use a font that the printer does not support, the printer will substitute one of its built-in fonts, and the print result will be different from the label image shown in P-touch Editor.

To prevent font substitution, select a font already installed in the printer, or transfer the font you want to use to the printer.

For information on how to transfer fonts, visit your model's **FAQs & Troubleshooting** page at support.brother.com.

2. Other Factors

There are other factors that may cause printing results to differ from the label image displayed in P-touch Editor. For more information, visit your model's **FAQs & Troubleshooting** page on support.brother.com.



Related Information

- [Create and Print Labels Using Your Computer](#)
-

Create Labels and Print without Installing Software and Drivers

- [Print Using the USB Interface \(Mass Storage Mode\)](#)
- [Notes on Printing Images without Using the Printer Driver](#)

Print Using the USB Interface (Mass Storage Mode)

The mass storage feature allows you to send a file to the printer using the USB interface, without installing the printer driver.

This feature is useful for:

- Applying printer settings saved in a command file (BIN file format) and adding templates (BLF file format) into your printer without using any software tools. Both types of files must be distributed by an administrator.
- Executing commands without installing the printer driver.
- Using a device with an operating system (including non-Windows operating systems) supporting a USB host feature to print and transmit data.

1. Confirm that the printer is turned off.
2. While pressing the **Menu / ▼** (Select) button, press and hold and the  (Power) button.

The printer starts up in mass storage mode. The message [Mass Storage] appears on the LCD.

3. Connect the computer or mobile device to the printer using a USB cable.

The printer's mass storage area appears as a folder on the computer's or device's screen.



If the mass storage area does not appear automatically, see the instructions for the operating system of your computer or mobile device for information about accessing the mass storage area.

4. Drag and drop the file you want to copy to the mass storage area.
5. Press the **Menu / ▼** (Select) button.

The command file is executed. The message [Receiving] appears on the LCD.
6. After the file has been executed, the message [Mass Storage] appears on the LCD.
7. To turn mass storage mode off, turn the printer off.

The printer will start up in its normal operating mode.

NOTE

- When the printer is turned off, mass storage mode is deactivated and any files in the mass storage area are deleted.
- This feature supports only BIN, BLF, and JPG files.
- Do not create folders in the mass storage area. If a folder is created, the files in the folder cannot be accessed.
- The capacity of the mass storage area is 15.8 MB.
- If multiple files are copied, the commands may not be executed.
- Only the USB connection is available while the printer is in mass storage mode.
- Do not access other files in the mass storage area when executing a copied file.



Related Information

- [Create Labels and Print without Installing Software and Drivers](#)

Notes on Printing Images without Using the Printer Driver

Mass Storage mode supports JPEG image printing. The printer converts colour JPEG files to monochrome using the dithering process, which could result in fuzzy images. To improve image quality, avoid or turn off any functions that preprocess images.



Your printer supports an Object Push Profile (OPP) when printing via Bluetooth.

- Only JPEG images can be printed, that is, this function is limited to files with the .jpg extension.
- The maximum file size is 16 MB.
- The maximum resolutions are as follows:
 - RJ-3235B/RJ-3255WB
Height × Width = 24000 dots × 576 dots
 - RJ-4235B/RJ-4255WB
Height × Width = 24000 dots × 832 dots

If these limits are exceeded, the data received by the printer is discarded and not printed.

- Print is at 1 pixel = 1 dot.
- The printer performs binary processing (simple binary) to print the image.
- The image is printed with the height-to-width proportions of the received data.



Related Information

- [Create Labels and Print without Installing Software and Drivers](#)

Print Labels Using the Printer Driver (Windows)

Make sure you have installed the printer driver.

For the latest drivers and software, go to your model's **Downloads** page at support.brother.com/downloads.

1. Connect the printer to a computer.
2. Open the document you want to print.
3. Select the print command in your application.
4. Select your printer, and then click the printer's properties or preferences button.
The printer driver window appears.
5. Change the printer driver settings, if needed.
6. Click **OK**.
7. Complete your print operation.



Related Information

- [Create and Print Labels Using Your Computer](#)

Print Labels Using Mobile Devices

- [Compatible Printing Apps](#)
- [AirPrint Overview](#)
- [Transfer Templates Created on a Computer to the Printer Using a Mobile Device](#)

Compatible Printing Apps

- RJ-3255WB/RJ-4255WB:
Brother offers various free apps for use with your printer, including apps to print directly from your iPhone, iPad, iPod touch, and Android™ mobile devices, and apps to wirelessly transfer data, such as templates, symbols, and databases created using a computer, to your stand-alone printer.
- RJ-3235B/RJ-4235B:
Brother offers various free apps for use with your printer, including apps to print directly from your iPhone, iPad, iPod touch, and Android™ mobile devices.

For more information about the mobile apps available for your printer, visit support.brother.com/g/d/f5f9/.

iOS Devices

Software	Features
Print SDK	Download the Software Development Kit (SDK) from the Brother Developer Center (https://support.brother.com/g/s/es/dev/en/index.html).
Mobile Transfer Express	This application allows you to use a mobile device to download databases and layout, which were created on a computer using P-touch Editor and saved to a cloud service, and send them to your printer. Download this Brother app from the App Store.
AirPrint (RJ-3255WB/RJ-4255WB)	Allows you to print from an Apple device (iPad, iPhone, or iPod touch) without installing additional software.
Mobile Deploy	Allows you to perform updates for the settings and firmware of printers using a mobile device. This software will send printer update files uploaded to DropBox or an HTTP(S) server to target printers. Download this Brother app from the App Store.

Android Devices

Software	Features
Print SDK	Download the Software Development Kit (SDK) from Brother Developer Center (https://support.brother.com/g/s/es/dev/en/index.html).
Mobile Transfer Express	This app allows you to use a mobile device to download databases and layouts, which were created on a computer using P-touch Editor and saved to a cloud service, and send them to your printer. Download this Brother app from Google Play™.
Print Service Plugin	Allows you to print from an Android device.
Mobile Deploy	Allows you to perform updates for the settings and firmware of printers using a mobile device. This software will send printer update files uploaded to DropBox or an HTTP(S) server to target printers. Download this Brother app from Google Play™.



Related Information

- [Print Labels Using Mobile Devices](#)

AirPrint Overview

Related Models: RJ-3255WB/RJ-4255WB

AirPrint is a printing solution for Apple operating systems that allows you to wirelessly print photos, email, web pages and documents from your iPad, iPhone and iPod touch without the need to install a driver.

For more information, visit Apple's website.

Use of the Works with Apple badge means that an accessory has been designed to work specifically with the technology identified in the badge and has been certified by the developer to meet Apple performance standards.



Related Information

- [Print Labels Using Mobile Devices](#)

Transfer Templates Created on a Computer to the Printer Using a Mobile Device

Save template data created using P-touch Editor in either BLF or PDZ format. Use Mobile Transfer Express to send the saved file from your mobile device to the printer and print it.

Make sure Mobile Transfer Express is installed on your mobile device.

1. Save the template data using P-touch Editor.



For more information, see *Related Topics: Create Transfer Files or Transfer Package Files (Windows)*

2. Do one of the following:
 - Save the file to a cloud storage service, and then share it using the Mobile Transfer Express app on your mobile device.
 - Send the file as an email attachment from your computer to a mobile device, and then save the file to the mobile device.
3. Connect the printer to your mobile device, and then start Mobile Transfer Express.
The template data appears.
4. Select the template you want to print, and then tap **Transfer** to transfer the template to the printer.



(RJ-3255WB/RJ-4255WB)

To download a file from a cloud storage service to your mobile device, connect your mobile device to the printer using Infrastructure Mode. This allows you to transfer downloaded files (BLF files only) faster.



Related Information

- [Print Labels Using Mobile Devices](#)

Related Topics:

- [Create Transfer Files and Transfer Package Files \(Windows\)](#)
- [Connect Using Wi-Fi](#)

Print Labels Using Barcode Scanner or Other Devices (P-touch Template)

- [P-touch Template Operations Overview](#)
- [Create and Print Labels Using P-touch Editor \(Windows\)](#)
- [Transfer a Template or Other Data from the Computer to the Printer \(Windows\)](#)
- [Transfer Multiple Items from the Computer to the Printer \(Windows\)](#)
- [Specify the Barcode Scanner Settings \(Windows\)](#)
- [Connect the Printer to a Barcode Scanner Using Bluetooth](#)
- [Try the P-touch Template Function Using the Barcode List](#)

P-touch Template Operations Overview

P-touch Template Mode allows you to insert data into text and barcode objects on templates transferred to the printer using other devices connected to the printer.



- P-touch Template Mode is also compatible with other input devices like scales, testing machines, controllers, or a programmable logic devices.
- For more information, see the *P-touch Template Manual/Command Reference* (English only). You can download the latest version from the Brother support website at support.brother.com/manuals.

Basic Operations

Recall Printing

Transfer frequently used templates and images to the printer in advance. Prepare a barcode containing numbers for template selection and information to start printing. Read the barcode with a barcode scanner connected to the printer to select the template and start printing.

Merge Printing

Download a template and scan a barcode to print a copy or to insert the scanned data into a different template.

Database Lookup Printing

Download a database linked to a template and scan a barcode to find a record to insert into the template and print.

See *Related Information*.

Advanced Operations

Numbered (Serialised Number) Printing

Increment printed text or barcodes in any downloaded template.

See *Related Information*.



Related Information

- [Print Labels Using Barcode Scanner or Other Devices \(P-touch Template\)](#)

Related Topics:

- [Recall and Print the Template Transferred to the Printer \(Recall Printing\)](#)
- [Insert Information into a Template Transferred to the Printer and Print It \(Merge Printing\)](#)
- [Print the Template Linked to the Database \(Database Lookup Printing\)](#)
- [Print Transferred Templates in Serialised \(Numerical\) Order \(Numbered \(Serialised Number\) Printing\)](#)

Create and Print Labels Using P-touch Editor (Windows)

To use your printer with your Windows computer, install your model's printer driver and P-touch Editor on your computer.

For the latest drivers and software, go to your model's **Downloads** page at support.brother.com/downloads.

1. Start P-touch Editor .

Click **Start > Brother P-touch > P-touch Editor**, or double-click the **P-touch Editor** icon on the desktop.

NOTE

Depending on your computer's operating system, the Brother P-touch folder may or may not be created.

2. Make sure your model's name is selected on the Home screen.
3. Do one of the following:
 - To create a new layout, click the **New Label** tab, and then click the **New Label** button (1).
 - To create a new layout using a preset layout, click the **New Label** tab, and then click a category button (2), select a template, and then click **Create** (3).
 - To open an existing layout, click **Open** (4).

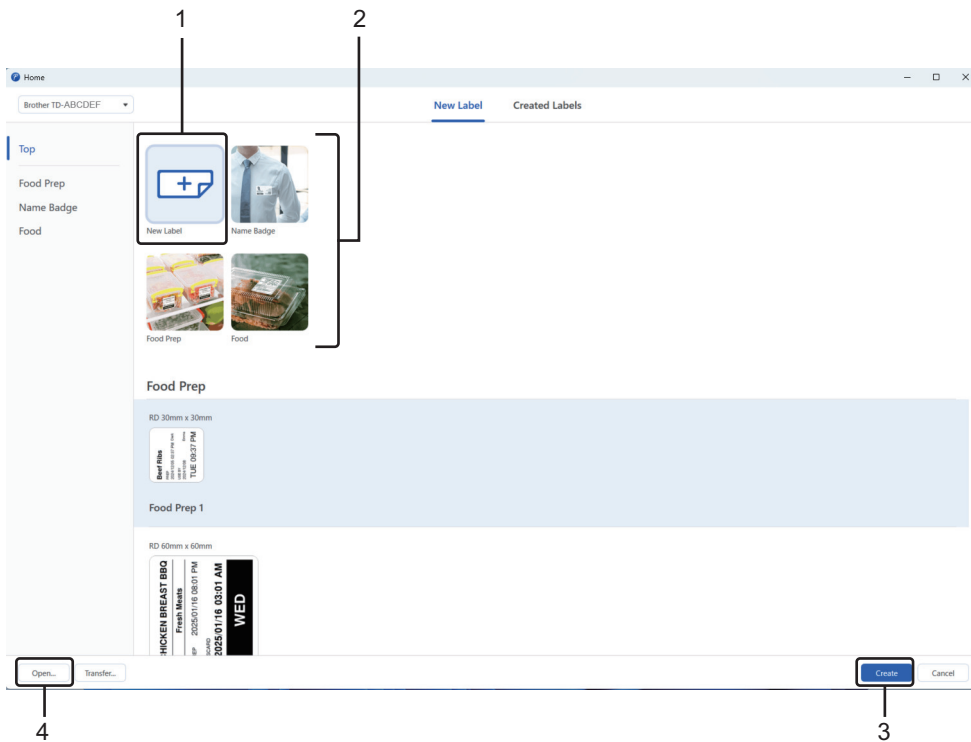

4. Click the **Print** icon.
5. Select the print settings you want, and then click **Print**.

Related Information

- [Print Labels Using Barcode Scanner or Other Devices \(P-touch Template\)](#)

Transfer a Template or Other Data from the Computer to the Printer (Windows)

1. Connect the printer to the computer using a USB cable/Network, and then turn the printer on.
2. Start P-touch Editor .

Click **Start > Brother P-touch > P-touch Editor**, or double-click the **P-touch Editor** icon on the desktop.

NOTE

Depending on your computer's operating system, the Brother P-touch folder may or may not be created.

3. Make sure your model's name is selected on the Home screen.
4. Open the template you want or create a new layout.
5. Click **File > Transfer Template**.

The Transfer window appears. The template or other data is listed in the window under **Transfer Name**.

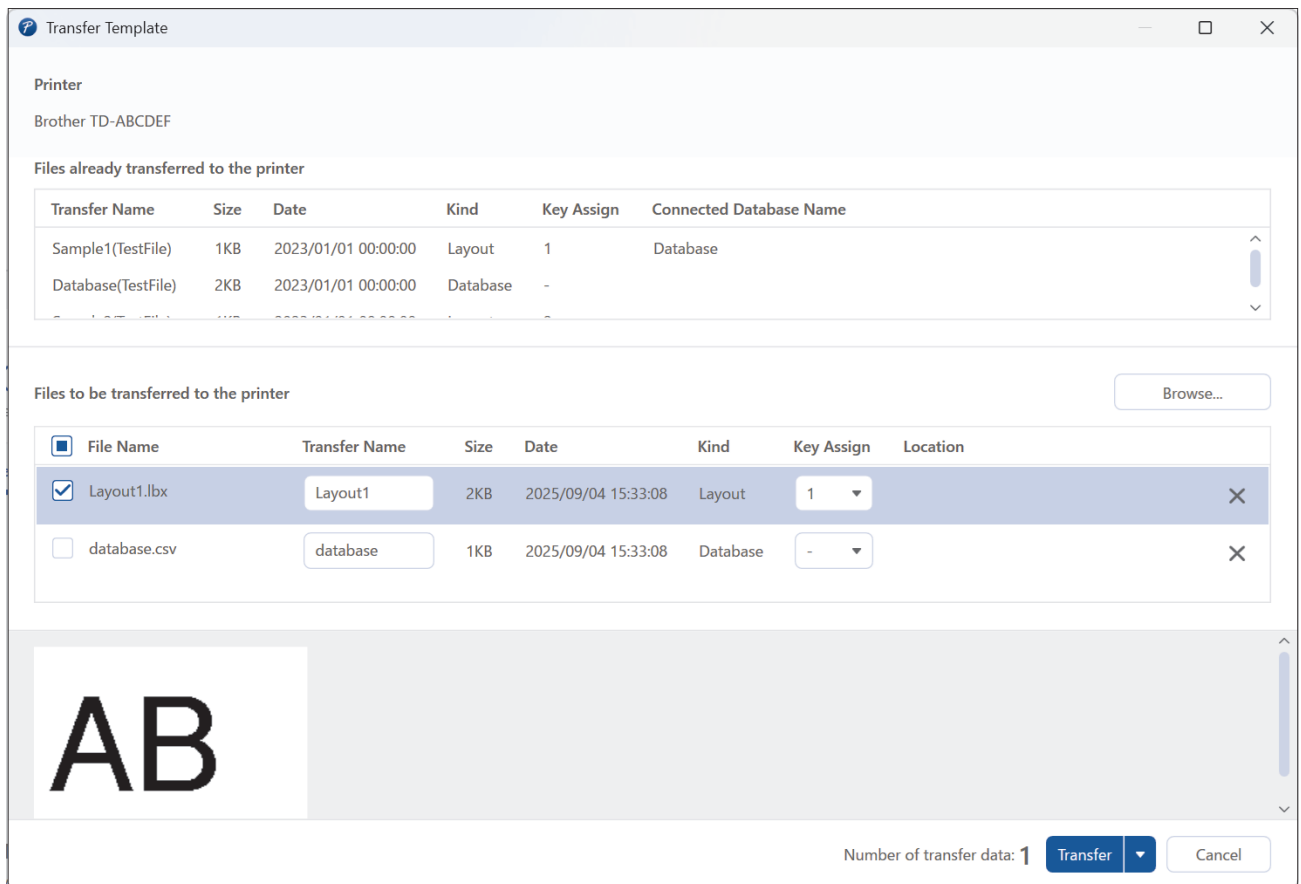

6. To change the **Key Assign** number, that is, the file location in the printer, assigned to a template, click the template file you want, and then select the **Key Assign** number.



Use Key Assign numbers to search for template files on your printer.

NOTE

- The database is not assigned a Key Assign number.
- The printer will overwrite any previously saved template that has the same Key Assign number as a new template being transferred to it.

-
- To change the transfer name of the template or other data, click the item you want, and then type the new name.

The number of characters allowed for the file name differs depending on the printer model.

- From the file list, select the template or other data you want to transfer, and then click **Transfer**.
- Click **OK**.

The selected items are transferred to the printer.



You can transfer multiple templates or other data at the same time. For more information, see *Related Topics: Transfer Multiple Items from the Computer to the Printer (Windows)*.



Related Information

- [Print Labels Using Barcode Scanner or Other Devices \(P-touch Template\)](#)

Related Topics:

- [Transfer Templates Created on a Computer to the Printer Using a Mobile Device](#)
 - [Confirm Printer Settings](#)
 - [Transfer Multiple Items from the Computer to the Printer \(Windows\)](#)
-

Transfer Multiple Items from the Computer to the Printer (Windows)

When you transfer multiple items using P-touch Editor, follow these guidelines.

Data Type	Maximum Number of Transferable Items	Restriction Details
Template	255	Each template can contain up to 255 objects (text and barcodes).
Database	255	<ul style="list-style-type: none">Only CSV files can be transferred.Each CSV file can contain a maximum of 100 columns and 10,000 records.
Image (transferred symbols)	255	<ul style="list-style-type: none">Only *.bmp files can be transferred.Monochrome *.bmp files are recommended.The size limit is 1296 x 1296 pixels.Wide images may be cropped.

1. Connect the printer to the computer using a USB cable/Network, and then turn the printer on.
2. Start P-touch Editor .

Click **Start > Brother P-touch > P-touch Editor**, or double-click the **P-touch Editor** icon on the desktop.

NOTE

Depending on your computer's operating system, the Brother P-touch folder may or may not be created.

3. Make sure your model's name is selected on the Home screen, and then click **Transfer**.
4. In the **Transfer** window, click **Browse** and specify the items you want to transfer.
The specified items appear in the file list.
5. Make sure the items you want to transfer are selected in the file list, and then click **Transfer**.
6. Click **OK**.
The selected items are transferred to the printer.



Related Information

- [Print Labels Using Barcode Scanner or Other Devices \(P-touch Template\)](#)

Related Topics:

- [Transfer a Template or Other Data from the Computer to the Printer \(Windows\)](#)

Specify the Barcode Scanner Settings (Windows)

Before connecting the barcode scanner to the printer, specify the barcode scanner settings using the P-touch Template Settings (in the BRConfiguration Tool).

For more information about the BRConfiguration Tool, go to the *BRConfiguration Tool Guide* at support.brother.com/g/s/es/html/doc/brconfiguration/eng/index.html.



Related Information

- [Print Labels Using Barcode Scanner or Other Devices \(P-touch Template\)](#)
-

Connect the Printer to a Barcode Scanner Using Bluetooth

We recommend using a reliable high-quality barcode scanner and checking the barcode scanner specifications before selecting a model.

We recommend using models that support Serial Port Profile (SPP) when scanning via Bluetooth.



- For P-touch Template mode, templates must first be downloaded from a computer to the printer using P-touch Editor.
- Contact the manufacturer for more information on how to use and program a specific barcode scanner model.
- Follow the recommendations of the manufacturer of your Bluetooth-equipped devices, such as barcode scanners, and install any necessary hardware and software.
- The Bluetooth connection settings are saved even after the printer is turned off.

1. Press the **Menu / ▼** (Select) button to select the [Bluetooth] menu, and then press the  (Feed) / **OK** button.

2. Select the [On/Off] menu, and then press the  (Feed) / **OK** button. Select [On].

 appears on the LCD.

3. Pair the printer with the barcode scanner via Bluetooth.

Press the **Menu / ▼** (Select) button, and then select [Bluetooth] > [Print Barcode] to print the Bluetooth address for connecting to a Bluetooth barcode scanner.

If the printer's PIN is required: the default PIN is the last four digits of the product serial number. The serial number is located on the bottom. You can change the PIN in the BRConfiguration Tool.

- During pairing, the Bluetooth passkey may appear on the screen. If you selected the **Pairing requires user confirmation on printer** checkbox in the Bluetooth tab of the Communication Settings dialog box, press the  (Feed) / **OK** button on the printer.
- Depending on the specifications of the barcode scanner, the pairing may not be successful if the setting requires key operation of the printer during pairing. In this case, deselect the **Pairing requires user confirmation on printer** checkbox in the Bluetooth tab of the Communication Settings dialog box.

When a connection has been established, the printer remains connected until it is turned off, preventing it from connecting to another device.



Related Information

- [Print Labels Using Barcode Scanner or Other Devices \(P-touch Template\)](#)

Try the P-touch Template Function Using the Barcode List

- [Recall and Print the Template Transferred to the Printer \(Recall Printing\)](#)
- [Insert Information into a Template Transferred to the Printer and Print It \(Merge Printing\)](#)
- [Print the Template Linked to the Database \(Database Lookup Printing\)](#)
- [Print Transferred Templates in Serialised \(Numerical\) Order \(Numbered \(Serialised Number\) Printing\)](#)
- [Barcodes Used for Specifying Settings](#)

Recall and Print the Template Transferred to the Printer (Recall Printing)

Transfer frequently used templates and images to the printer in advance. Prepare a barcode containing numbers for template selection and information to start printing. Read the barcode with a barcode scanner connected to the printer to select the template and start printing.

Example:



- For more information on the barcodes scanned using various settings, see *Related Information*.
- Grouped objects are converted and sent as an image.
- The following these barcodes may not be available depending on the model.

1. Use P-touch Editor to transfer a template or label layout from the computer to the printer.

For more detailed information, see *Related Information*.

2. Scan the following barcode:

P-touch template command (initialise + begin specifying settings)



3. From the following barcode list, scan each barcode to send a command or setting to the printer:

Basic settings

<p>Auto cut on (Cut every one label) + Cut at end on</p> <p>^C01011</p>	<p>Auto cut on (Cut every two labels) + Cut at end on</p> <p>^C01021</p>
<p>Auto cut off + Cut at end on</p> <p>^C00001</p>	<p>Auto cut off + Cut at end off</p> <p>^C00000</p>



- Settings can be made with multiple commands.
- If no settings have been made by scanning the barcode commands, a template is printed using the P-touch Template settings. The default P-touch Template settings are to print a single copy with Auto Cut turned on.

For more information on P-touch Template Settings, see the *P-touch Template Manual/Command Reference* (English only). You can download the latest version from the Brother support website at support.brother.com/manuals.

4. Specify the number of copies you want.

a. Scan the following barcode:

Number of copies













b. Scan the following barcodes to specify a three-digit number:

Example:

Specify numbers by scanning the following barcodes: when printing 7 sheets; [0][0][7], when printing 15 sheets; [0][1][5]

For entering numbers









1  1	2  2
3  3	4  4
5  5	6  6
7  7	8  8
9  9	0  0
00  00	



To change the setting for the number of copies, repeat these steps.

- Scan one of the following barcodes with the same number as the Key Assign number for the label layout you want:

Preset template number

Preset template 1  ^TS001^FF	Preset template 2  ^TS002^FF
Preset template 3  ^TS003^FF	Preset template 4  ^TS004^FF
Preset template 5  ^TS005^FF	Preset template 6  ^TS006^FF
Preset template 7  ^TS007^FF	Preset template 8  ^TS008^FF

Preset template 9



^TS009^FF

Preset template 10



^TS010^FF

The specified label is printed.



Related Information

- [Try the P-touch Template Function Using the Barcode List](#)
 - [Lock Labels for Editing](#)

Related Topics:

- [Barcodes Used for Specifying Settings](#)
-

Lock Labels for Editing

To protect frequently used templates from unwanted edits, convert a text object in the label layout to an image. After converting the label layout to an image, the text cannot be changed.

1. When you insert a text object in the P-touch Editor Layout window, the **Expanded** tab will appear in the properties on the right.
2. Click the **More** tab, and then select the **Disable text editing** checkbox.



Related Information

- [Recall and Print the Template Transferred to the Printer \(Recall Printing\)](#)
-

Insert Information into a Template Transferred to the Printer and Print It (Merge Printing)

Transfer a template to the printer. Print the transferred template by inserting the information read from the barcode scanner connected to the printer.



- For more information on the barcodes scanned using various settings, see *Related Information*.
- If a barcode has a different protocol than the barcode template already registered with the printer, you may be unable to create or print the barcode.
- Depending on the barcode scanner model, some barcode standards and protocols may not be supported by this printer.

1. Use P-touch Editor to transfer a template or label layout from the computer to the printer.

For more detailed information, see *Related Information*.

NOTE

It is important to design a template to meet the barcode symbology or protocol requirements, especially for the label size and barcode position in the label to fit the maximum number and type of characters being inserted from the barcode scanner. A barcode in the template cannot be created or scanned if the barcode with the inserted data does not fit entirely within the label printable image area.

2. Open the template you want or create a new layout and click **File > Transfer Template**.
 - To change the Key Assign number (memory location in the printer) assigned to an item, click the item you want, and then select the number.
 - To change the transfer name of the template or other data, click the item you want, and then type the new name. The number of characters differs depending on the printer model.

NOTE

- The database is not assigned a Key Assign number.
- The printer will overwrite any previously saved template that has the same key number as a new template being transferred to it.

3. Make sure the template or other data you want to transfer is selected in the file list, and then click **Transfer** and click **OK**.
4. Scan the following barcode:

P-touch template command (initialise + begin specifying settings)



Esq]ia3^11

5. From the following barcode list, scan each barcode to send a command or setting to the printer:

Basic settings

Auto cut on (Cut every one label) + Cut at end on





^c01011

Auto cut on (Cut every two labels) + Cut at end on



^c01021

Auto cut off + Cut at end on  ^c00001	Auto cut off + Cut at end off  ^c00000
Number of copies  ^cN	



- Settings can be made with multiple commands.
- If no settings have been made by scanning the barcode commands, a template is printed using the P-touch Template settings. The default P-touch Template settings are to print a single copy with Auto Cut turned on.

For more information on P-touch Template Settings, see the *P-touch Template Manual/Command Reference* (English only). You can download the latest version from the Brother support website at support.brother.com/manuals.

6. Specify the number of copies you want.

- a. Scan the following barcode:

Number of copies









- b. Scan the following barcodes to specify a three-digit number:

Example:

Specify numbers by scanning the following barcodes: when printing 7 sheets; [0][0][7], when printing 15 sheets; [0][1][5]

For entering numbers

1  1	2  2
3  3	4  4
5  5	6  6
7  7	8  8
9  9	0  0

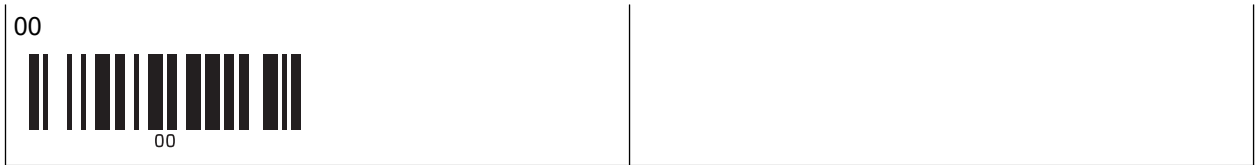

To change the setting for the number of copies, repeat these steps.

7. Scan the following barcode:

Select template



8. Scan the following barcodes with the same number (three digits) as the Key Assign number used for the downloaded template to be printed:

Example:

Specify numbers by scanning the following barcodes: when printing number 7; [0][0][7], when printing number 15; [0][1][5]

For entering numbers

1 	2
3 	4
5 	6
7 	8
9 	0
00 	

The downloaded template is selected after the three digit numbers have been scanned.



You can use P-touch Editor to create and print a label with a single barcode.

Example:



9. Scan a barcode containing the data you want inserted into the barcode object in the selected downloaded template.

Example:



10. Scan the following barcode to send the command to start printing:

Begin printing



The barcode in the printed template contains the data from the barcode scanned.

Example:



Related Information

- [Try the P-touch Template Function Using the Barcode List](#)

Related Topics:

- [Barcodes Used for Specifying Settings](#)
-

Print the Template Linked to the Database (Database Lookup Printing)

Transfers the template and the database linked to the template to the printer. By using the barcode as a keyword, it is possible to search the database for records containing the keyword and to print the template with the search result merged into it.



- For more information on the barcodes scanned using various settings, see *Related Information*.
- The printer has reserved the leftmost column (A) of a downloaded linked database for this operation, therefore the keyword scanned from a barcode must be in this column of the database.
- For the printer to find keywords successfully, the data in the leftmost column (A) must exactly match the keywords scanned from a barcode.
- P-touch Editor and the printer can read only one line of data in each field of a linked database so we do not recommend using databases with two or more lines of data in the leftmost column (A).

1. Use P-touch Editor to create a template and connect to a database file.



- You can link as many columns to a text and barcode objects in the template as needed.
- Make sure the keywords are included in the leftmost column (A) but do not link any text or barcode object in the template with field (A) if you do not need the data on the printed label.



- For more information on specifying the settings, refer to the **P-touch Editor Help** menu.

2. Use P-touch Editor to transfer a template or label layout from the computer to the printer.

For more information, see *Related Information*.

The linked database file will also be transferred.

3. Select the transferred template, and then click **Transfer** to download the template to the Key Assign number in the printer.

4. Scan the following barcode:





P-touch template command (initialise + begin specifying settings)



Esc]ia3^I1

5. From the following barcode list, scan each barcode to send a command or setting to the printer:

Basic settings

<p>Auto cut on (Cut every one label) + Cut at end on</p>  <p>^c01011</p>	<p>Auto cut on (Cut every two labels) + Cut at end on</p>  <p>^c01021</p>
<p>Auto cut off + Cut at end on</p>  <p>^c00001</p>	<p>Auto cut off + Cut at end off</p>  <p>^c00000</p>

Number of copies



- Settings can be made with multiple commands.
- If no settings have been made by scanning the barcode commands, a template is printed using the P-touch Template settings. The default P-touch Template settings are to print a single copy with Auto Cut turned on.

For more information on P-touch Template Settings, see the *P-touch Template Manual/Command Reference* (English only). You can download the latest version from the Brother support website at support.brother.com/manuals.

6. Specify the number of copies you want.

- a. Scan the following barcode:

Number of copies













- b. Scan the following barcodes to specify a three-digit number:

Example:

Specify numbers by scanning the following barcodes: when printing 7 sheets; [0][0][7], when printing 15 sheets; [0][1][5]

For entering numbers

1  1	2  2
3  3	4  4
5  5	6  6
7  7	8  8
9  9	0  0
00  00	



To change the setting for the number of copies, repeat these steps.

7. Scan the following barcode:

Select template













8. Scan the following barcodes with the same number (three digits) as the Key Assign number used for the downloaded template to be printed:

Example:

Specify numbers by scanning the following barcodes: when printing number 7; [0][0][7], when printing number 15; [0][1][5]

For entering numbers

1  1	2  2
3  3	4  4
5  5	6  6
7  7	8  8
9  9	0  0
00  00	

The downloaded template is selected after the three digit numbers have been scanned.



You can use P-touch Editor to create and print a label with a single barcode.

Example:



9. Scan a barcode containing the keyword to look up in the downloaded database.

Example:



10. Scan the following barcode to send the command to start searching the downloaded database for the scanned keyword:

Delimiter



11. Scan the following barcode to send the command to start printing:

Begin printing



You can use P-touch Editor to create and print a label with a single barcode.

Example:



The printer prints the template with the data inserted from the database record, found with the scanned keyword.

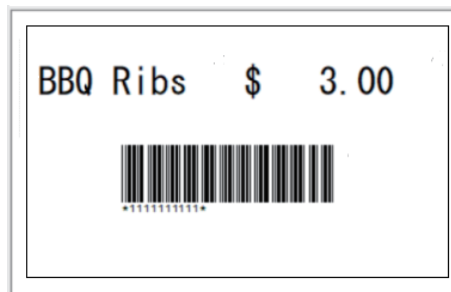

Related Information

- [Try the P-touch Template Function Using the Barcode List](#)

Related Topics:

- [Barcodes Used for Specifying Settings](#)
-

Print Transferred Templates in Serialised (Numerical) Order (Numbered (Serialised Number) Printing)

You can increase text numbers or barcodes up to 999 when printing downloaded templates. Select text or barcode objects to increment while printing.

- >> [Text Numbering \(Serialising\)](#)
- >> [Barcode Numbering \(Serialising\)](#)
- >> [Use the Numbering \(Serialising\) Advanced Operation](#)

Text Numbering (Serialising)

1. Use P-touch Editor to create or open a template and select a text object you want to increment while printing.

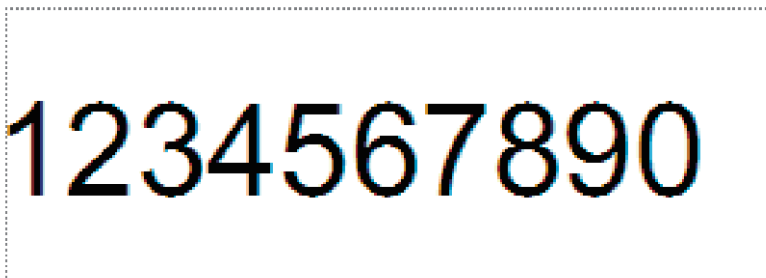

2. Highlight or drag the cursor over a group of numbers and letters within the text object you want to increment. The selected group is called the Numbering field.



3. When you insert a text object in the P-touch Editor Layout window, the **Text** tab will appear in the properties on the right. On the **Text** tab, select the **Numbering** menu.

Barcode Numbering (Serialising)

1. Use P-touch Editor to create or open a template and select a barcode object you want to increment while printing.
2. Click the barcode object, and the **Barcode** tab will appear in the properties on the right. On the **Barcode** tab, select the **Numbering** menu.

Use the Numbering (Serialising) Advanced Operation

1. Use P-touch Editor to transfer a template or label layout from the computer to the printer. For more information, see *Related Information*.
2. Scan the following barcode:

Number of serialised copies













^NN

3. Scan the following barcodes with the number of copies you want to print (three digits):

Example:

For five copies, specify the three digit numbers by scanning barcodes for [0][0][5]

For entering numbers

1 	2 
3 	4 
5 	6 
7 	8 
9 	0 
00 	

4. Follow the P-touch Template mode basic operation procedures to start printing.



- The Numbering field increments by one number or letter with each printed label, and the count is permanently saved in the printer.
- To reset a text or barcode object back to the original value, scan the following barcode:

Initialise template data



Related Information

- [Try the P-touch Template Function Using the Barcode List](#)

Related Topics:

- [Barcodes Used for Specifying Settings](#)

Barcodes Used for Specifying Settings



- When using the barcodes in this list, make the following settings.
 - Printer: Set the **Trigger for P-touch Template Printing** and **Command Prefix Character** options to the factory settings in the P-touch Template Settings tool.
 - Barcode Scanner: Remove any prefix and suffix characters.
- Make sure you print the barcodes at a high resolution so that the barcode scanner can read them correctly to print the labels you want.

P-touch template command (initialise + begin specifying settings)







Basic settings

<p>Auto cut on (Cut every one label) + Cut at end on</p> <p>^c01011</p>	<p>Auto cut on (Cut every two labels) + Cut at end on</p> <p>^c01021</p>
<p>Auto cut off + Cut at end on</p> <p>^c00001</p>	<p>Auto cut off + Cut at end off</p> <p>^c00000</p>
<p>Number of copies</p> <p>^CN</p>	











- For entering numbers

These are used when specifying the number of copies printed and when selecting a template number. Scan barcodes to specify a three-digit number, such as [0][0][7] or [0][1][5]. The setting is applied when three digits have been specified. To change settings, scan the “Number of copies” barcode again when changing the number of copies or scan the “Select template” barcode again when changing the template number, and then scan the barcodes for the new three-digit number.

<p>1</p> <p>1</p>	<p>2</p> <p>2</p>
<p>3</p> <p>3</p>	<p>4</p> <p>4</p>
<p>5</p> <p>5</p>	<p>6</p> <p>6</p>

7  7	8  8
9  9	0  0
00  00	

- Preset template number

Preset template 1  ^TS001^FF	Preset template 2  ^TS002^FF
Preset template 3  ^TS003^FF	Preset template 4  ^TS004^FF
Preset template 5  ^TS005^FF	Preset template 6  ^TS006^FF
Preset template 7  ^TS007^FF	Preset template 8  ^TS008^FF
Preset template 9  ^TS009^FF	Preset template 10  ^TS010^FF

- Select template



- Number of serialised copies



- Delimiter



- Initialise template data



^ID

- Begin printing



^FF



Related Information

- [Try the P-touch Template Function Using the Barcode List](#)

Transfer Templates to the Printer Using Your Computer (Windows)

- [Create Transfer Files and Transfer Package Files \(Windows\)](#)

Create Transfer Files and Transfer Package Files (Windows)

Create transfer files (BLF) or transfer package files (PDZ) with templates enclosed, so that these templates can be used on other remote printers.

You can also print files in the BLF format using Mass Storage Mode.

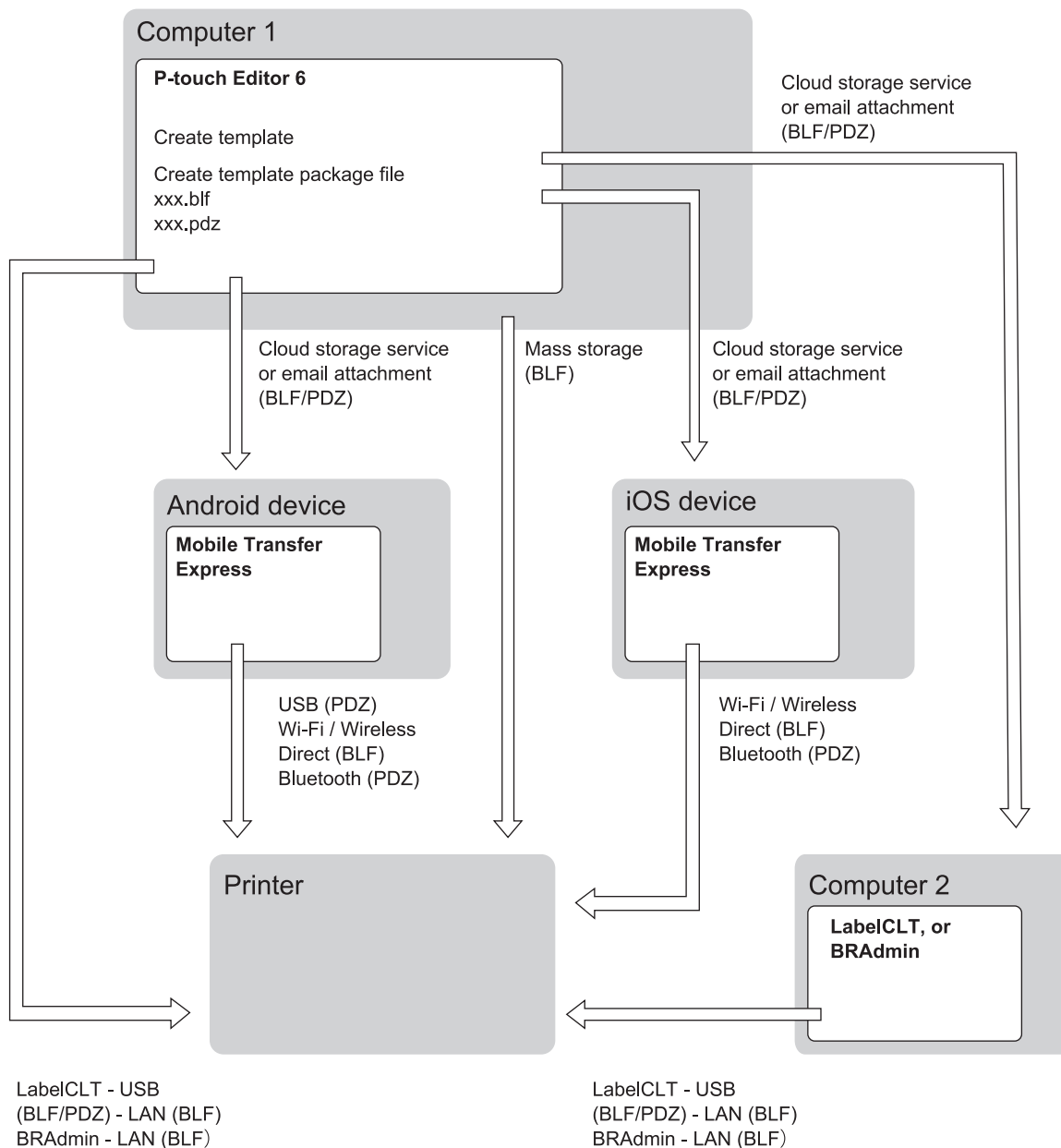

Template Transfer Method		File Format
From a mobile device (Using Mobile Transfer Express)	via USB	PDZ
	via Wi-Fi (RJ-3255WB/RJ-4255WB)	BLF
	via Wireless Direct (RJ-3255WB/RJ-4255WB)	BLF
	via Bluetooth	PDZ
	Mass storage	BLF

Template Transfer Method		File Format
From a computer	Mass storage	BLF

1. Connect the printer to the computer using a USB cable/Network, and then turn the printer on.
2. Start P-touch Editor .

Click **Start > Brother P-touch > P-touch Editor**, or double-click the **P-touch Editor** icon on the desktop.

NOTE

Depending on your computer's operating system, the Brother P-touch folder may or may not be created.

3. Make sure your model's name is selected on the Home screen, and then click **Transfer**.
4. In the **Transfer** window, click **Browse** and specify the items you want to transfer.
The specified items appear in the file list.
5. Make sure the items you want to export are selected in the file list, and then click **Export**.
6. Specify the file path, the file name, and select Transfer files (BLF) or Transfer Package files (PDZ) as the file type.
7. Click **Save**.



Related Information

- [Transfer Templates to the Printer Using Your Computer \(Windows\)](#)

Network

Related Models: RJ-3235B/RJ-3255WB/RJ-4255WB

- [Important Information for Security](#)
- [Wireless Network Settings](#)
- [Network Features](#)
- [Brother Management Tools](#)

Important Information for Security

- The default password to manage this machine's settings is located on the bottom of the machine and marked "**Pwd:**". We recommend immediately changing the default password to protect your machine from unauthorised access.
- When connecting your machine to an outside network such as the Internet, make sure your network environment is protected by a separate firewall or other means in order to prevent information leaks due to inadequate settings or unauthorised access by malicious third parties.
- If there is a signal in the vicinity, wireless LAN allows you to freely make a LAN connection. However, if security settings are not correctly configured, the signal may be intercepted by malicious third-parties, possibly resulting in:
 - Theft of personal or confidential information
 - Improper transmission of information to parties impersonating the specified individuals
 - Dissemination of transcribed communication contents that were intercepted



Related Information

- [Network](#)
-

Wireless Network Settings

Related Models: RJ-3255WB/RJ-4255WB

- [Use the Wireless Network](#)
- [Enable/Disable Wi-Fi](#)

Use the Wireless Network

Related Models: RJ-3255WB/RJ-4255WB

- [Before Configuring Your Machine for a Wireless Network](#)

Before Configuring Your Machine for a Wireless Network

Related Models: RJ-3255WB/RJ-4255WB

Before attempting to configure a wireless network, confirm the following:

- If you are using an enterprise wireless network, you must know the User ID and Password.
- To achieve optimum results with normal everyday document printing, place your machine as close to the wireless LAN access point/router as possible with minimal obstructions. Large objects and walls between the two devices and interference from other electronic devices can affect the data transfer speed of your documents.

Due to these factors, wireless may not be the best method of connection for all types of documents and applications.

- If there is a signal in the vicinity, wireless LAN allows you to freely make a LAN connection. However, if security settings are not correctly configured, the signal may be intercepted by malicious third parties, possibly resulting in:
 - Theft of personal or confidential information
 - Improper transmission of information to parties impersonating the specified individuals
 - Dissemination of transcribed communication contents that were intercepted



Make sure you know your wireless router/access point's Network Name (SSID) and Network Key (Password). If you cannot find this information, consult the manufacturer of your wireless router/access point, your system administrator, or Internet provider. Brother cannot provide this information.





Related Information

- [Use the Wireless Network](#)

Enable/Disable Wi-Fi

Related Models: RJ-3255WB/RJ-4255WB

1. Press the **Menu / ▼** (Select) button to select the [WLAN] menu, and then press the  (Feed) / **OK** button.
2. Do one of the following:
 - To enable Wi-Fi, select [On].
 - To disable Wi-Fi, select [Off].
3. Select [On/Off] and then press the  (Feed) / **OK** button.



Related Information

- [Wireless Network Settings](#)

Network Features

Related Models: RJ-3235B/RJ-3255WB/RJ-4255WB

- [Synchronise Time with the SNTP Server Using Web Based Management](#)

Synchronise Time with the SNTP Server Using Web Based Management

Related Models: RJ-3235B/RJ-3255WB/RJ-4255WB

The Simple Network Time Protocol (SNTP) is used to synchronise the time used by the machine for authentication with the SNTP time server. You can automatically or manually synchronise the machine's time with the Coordinated Universal Time (UTC) provided by the SNTP time server.

- [Configure Date and Time Using Web Based Management](#)
- [Configure the SNTP Protocol Using Web Based Management](#)

Configure Date and Time Using Web Based Management

Related Models: RJ-3235B/RJ-3255WB/RJ-4255WB

Configure the date and time to synchronise the time used by the machine with the SNTP time server.

This feature is not available in some countries.

1. Start your web browser.
2. Type "https://machine's IP address" in your browser's address bar (where "machine's IP address" is your machine's IP address).

For example:

https://192.168.1.2

You will find your machine's IP address in the Network Configuration Report.

3. If required, type the password in the **Login** field, and then click **Login**.



The default password to manage this machine's settings is located on the bottom of the machine and marked "**Pwd**". Change the default password by following the on-screen instructions when you first log in.

4. In the left navigation bar, click **Administrator > Date&Time**.



If the left navigation bar is not visible, start navigating from ☰.

5. Verify the **Time Zone** settings.



Select the time difference between your location and UTC from the **Time Zone** drop-down list. For example, the time zone for Eastern Time in the USA and Canada is UTC-05:00.

6. Click **Submit**.



Related Information

- [Synchronise Time with the SNTP Server Using Web Based Management](#)

Configure the SNTP Protocol Using Web Based Management

Related Models: RJ-3235B/RJ-3255WB/RJ-4255WB

Configure the SNTP protocol to synchronise the time the machine uses for authentication with the time kept by the SNTP time server.

1. Start your web browser.
2. Type "https://machine's IP address" in your browser's address bar (where "machine's IP address" is your machine's IP address).

For example:

https://192.168.1.2

You will find your machine's IP address in the Network Configuration Report.

3. If required, type the password in the **Login** field, and then click **Login**.



The default password to manage this machine's settings is located on the bottom of the machine and marked "**Pwd**". Change the default password by following the on-screen instructions when you first log in.

4. In the left navigation bar, click **Network > Network > Protocol**.



If the left navigation bar is not visible, start navigating from ☰.

5. Select the **SNTP** checkbox to activate the settings.
6. Click **Submit**.
7. Restart your Brother machine to activate the configuration.
8. Next to the SNTP checkbox, click **Advanced Settings**.
9. Configure the settings.

Option	Description
Status	Displays whether the SNTP protocol is enabled or disabled.
Synchronization Status	Confirm the latest synchronisation status.
SNTP Server Method	Select AUTO or STATIC . <ul style="list-style-type: none">• AUTO If you have a DHCP server on your network, the SNTP server will obtain the address from that server automatically.• STATIC Type the address you want to use.
Primary SNTP Server Address Secondary SNTP Server Address	Type the server's address (up to 64 characters). The secondary SNTP server's address is used as a backup to the primary SNTP server's address. If the primary server is unavailable, the machine will contact the secondary SNTP server.
Primary SNTP Server Port Secondary SNTP Server Port	Type the port number (1-65535). The secondary SNTP server port is used as a backup to the primary SNTP server port. If the primary port is unavailable, the machine will contact the secondary SNTP port.
Synchronization Interval	Type the number of hours between server synchronisation attempts (1-168 hours).

10. Click **Submit**.



Related Information

- [Synchronise Time with the SNTP Server Using Web Based Management](#)
-

Brother Management Tools

Related Models: RJ-3235B/RJ-3255WB/RJ-4255WB

Use one of Brother's management tools to configure your Brother machine's network settings. Go to your model's **Downloads** page at support.brother.com/downloads to download the tools.



Related Information

- [Network](#)
-

Security

Related Models: RJ-3235B/RJ-3255WB/RJ-4255WB

- [Before You Use Security Features](#)
- [Configure Certificates for Device Security](#)
- [Use SSL/TLS](#)
- [Use SNMPv3](#)
- [Use IEEE 802.1x Authentication for Your Network](#)

Before You Use Security Features

Related Models: RJ-3235B/RJ-3255WB/RJ-4255WB

Your machine employs some of the latest network security and encryption protocols available today. These network features can be integrated into your overall network security plan to help protect your data and prevent unauthorised access to the machine.



We recommend disabling the FTP and TFTP protocols. Accessing the machine using these protocols is not secure.



Related Information

- [Security](#)

Configure Certificates for Device Security

Related Models: RJ-3235B/RJ-3255WB/RJ-4255WB

You must configure a certificate to manage your networked machine securely using SSL/TLS. You must use Web Based Management to configure a certificate.

- [Security Certificate Features Overview](#)
- [How to Create and Install a Certificate](#)
- [Create a Self-signed Certificate](#)
- [Create a Certificate Signing Request \(CSR\) and Install a Certificate from a Certificate Authority \(CA\)](#)
- [Import and Export the Certificate and Private Key](#)
- [Import and Export a CA Certificate](#)
- [Manage Multiple Certificates](#)

Security Certificate Features Overview

Related Models: RJ-3235B/RJ-3255WB/RJ-4255WB

Your machine supports the use of multiple security certificates, which allows secure management, authentication, and communication with the machine. The following security certificate features can be used with the machine:

- SSL/TLS communication
- IEEE 802.1x authentication

Your machine supports the following:

- Pre-installed certificate

Your machine has a pre-installed self-signed certificate. This certificate enables you to use SSL/TLS communication without creating or installing a different certificate.



The pre-installed self-signed certificate protects your communication up to a certain level. We recommend using a certificate that is issued by a trusted organisation for better security.

- Self-signed certificate

This print server issues its own certificate. Using this certificate, you can easily use the SSL/TLS communication without creating or installing a different certificate from a CA.

- Certificate from a Certificate Authority (CA)

There are two methods for installing a certificate from a CA. If you already have a certificate from a CA or if you want to use a certificate from an external trusted CA:

- When using a Certificate Signing Request (CSR) from this print server.
- When importing a certificate and a private key.

- Certificate Authority (CA) Certificate

To use a CA certificate that identifies the CA and owns its private key, you must import that CA certificate from the CA before configuring the security features of the Network.



- If you are going to use SSL/TLS communication, we recommend contacting your system administrator first.
- When you reset the print server back to its default factory settings, the certificate and the private key that are installed will be deleted. If you want to keep the same certificate and the private key after resetting the print server, export them before resetting, and then reinstall them.



Related Information

- [Configure Certificates for Device Security](#)

How to Create and Install a Certificate

Related Models: RJ-3235B/RJ-3255WB/RJ-4255WB

There are two options when choosing a security certificate: use a self-signed certificate or use a certificate from a Certificate Authority (CA).

Option 1

Self-Signed Certificate

1. Create a self-signed certificate using Web Based Management.
2. Install the self-signed certificate on your computer.

Option 2

Certificate from a CA

1. Create a Certificate Signing Request (CSR) using Web Based Management.
2. Install the certificate issued by the CA on your Brother machine using Web Based Management.
3. Install the certificate on your computer.



Related Information

- [Configure Certificates for Device Security](#)

Create a Self-signed Certificate

Related Models: RJ-3235B/RJ-3255WB/RJ-4255WB

1. Start your web browser.
2. Type "https://machine's IP address" in your browser's address bar (where "machine's IP address" is your machine's IP address).
For example:
https://192.168.1.2
You will find your machine's IP address in the Network Configuration Report.
3. If required, type the password in the **Login** field, and then click **Login**.



The default password to manage this machine's settings is located on the bottom of the machine and marked "**Pwd**". Change the default password by following the on-screen instructions when you first log in.

4. In the left navigation bar, click **Network > Security > Certificate**.



If the left navigation bar is not visible, start navigating from ☰.

5. Click **Create Self-Signed Certificate**.
6. Enter a **Common Name** and a **Valid Date**.
 - The length of the **Common Name** is less than 64 bytes. Enter an identifier, such as an IP address, node name, or domain name to use when accessing this machine through SSL/TLS communication. The node name is displayed by default.
 - A warning will appear if you use the IPPS or HTTPS protocol and enter a different name in the URL than the **Common Name** that was used for the self-signed certificate.
7. Select your setting from the **Public Key Algorithm** drop-down list.
The supported public key algorithm is **RSA(2048bit)** or **RSA(1024bit)**.
8. Select your setting from the **Digest Algorithm** drop-down list.
The supported message digest algorithm is **SHA1** or **SHA256**.
9. Click **Submit**.



Related Information

- [Configure Certificates for Device Security](#)

Create a Certificate Signing Request (CSR) and Install a Certificate from a Certificate Authority (CA)

Related Models: RJ-3235B/RJ-3255WB/RJ-4255WB

If you already have a certificate from an external trusted Certificate Authority (CA), you can store the certificate and private key on the machine and manage them by importing and exporting. If you do not have a certificate from an external trusted CA, create a Certificate Signing Request (CSR), send it to a CA for authentication, and install the returned certificate on your machine.

- [Create a Certificate Signing Request \(CSR\)](#)
- [Install a Certificate on Your Machine](#)

Create a Certificate Signing Request (CSR)

Related Models: RJ-3235B/RJ-3255WB/RJ-4255WB

A Certificate Signing Request (CSR) is a request sent to a Certificate Authority (CA) to authenticate the credentials contained within the certificate.

We recommend installing a Root Certificate from the CA on your computer before creating the CSR.

1. Start your web browser.
2. Type "https://machine's IP address" in your browser's address bar (where "machine's IP address" is your machine's IP address).

For example:

https://192.168.1.2

Your machine's IP address can be found in the Network Configuration Report.



- If you are using a Domain Name System or enable a NetBIOS name, you can type another name, such as "SharedPrinter" instead of the IP address.

For example: https://SharedPrinter

- If you enable a NetBIOS name, you can also use the node name.

For example: https://brn123456abcdef

- The NetBIOS name can be found in the Network Configuration Report.

Web Based Management appears.

3. If required, type the password in the **Login** field, and then click **Login**.



The default password to manage this machine's settings is located on the bottom of the machine and marked "**Pwd**". Change the default password by following the on-screen instructions when you first log in.

4. In the left navigation bar, click **Network > Security > Certificate**.



If the left navigation bar is not visible, start navigating from ☰.

5. Click **Create CSR**.
6. Type a **Common Name** (required) and add other information about your **Organization** (optional).



- Your company details are required so that a CA can confirm your identity and verify it to the outside world.
- The length of the **Common Name** must be less than 64 bytes. Enter an identifier, such as an IP address, node name, or domain name to use when accessing this printer through SSL/TLS communication. The node name is displayed by default. The **Common Name** is required.
- A warning will appear if you type a different name in the URL than the Common Name that was used for the certificate.
- The length of the **Organization**, the **Organization Unit**, the **City/Locality** and the **State/Province** must be less than 64 bytes.
- The **Country/Region** should be a two character ISO 3166 country code.
- If you are configuring an X.509v3 certificate extension, select the **Configure extended partition** checkbox, and then select **Auto (Register IPv4)** or **Manual**.

7. Select your setting from the **Public Key Algorithm** drop-down list. The default setting is **RSA(2048bit)**.
8. Select your setting from the **Digest Algorithm** drop-down list. The default setting is **SHA256**.
9. Click **Submit**.

The CSR appears on your screen. Save the CSR as a file or copy and paste it into an online CSR form offered by a Certificate Authority.

10. Click **Save**.



-
- Follow your CA's policy regarding the method to send a CSR to your CA.
 - If you are using the Enterprise root CA of Windows Server 2012/2012 R2/2016/2019, we recommend using the Web Server for the certificate template to securely create the Client Certificate. If you are creating a Client Certificate for an IEEE 802.1x environment with EAP-TLS authentication, we recommend using User for the certificate template.
-



Related Information

- [Create a Certificate Signing Request \(CSR\) and Install a Certificate from a Certificate Authority \(CA\)](#)
-

Install a Certificate on Your Machine

Related Models: RJ-3235B/RJ-3255WB/RJ-4255WB

When you receive a certificate from a Certificate Authority (CA), follow the steps below to install it on the print server:

Only a certificate issued with your machine's Certificate Signing Request (CSR) can be installed on your machine. When you want to create another CSR, make sure that the certificate is installed before creating the new CSR. Create another CSR only after installing the certificate on the machine, otherwise the CSR created before installing the new CSR will be invalid.

1. Start your web browser.
2. Type "https://machine's IP address" in your browser's address bar (where "machine's IP address" is your machine's IP address).

For example:

https://192.168.1.2

You will find your machine's IP address in the Network Configuration Report.

3. If required, type the password in the **Login** field, and then click **Login**.



The default password to manage this machine's settings is located on the bottom of the machine and marked "**Pwd**". Change the default password by following the on-screen instructions when you first log in.

4. In the left navigation bar, click **Network > Security > Certificate**.



If the left navigation bar is not visible, start navigating from ☰.

5. Click **Install Certificate**.
6. Browse to the file that contains the certificate issued by the CA, and then click **Submit**.

The certificate is created and saved in your machine's memory.

- The certificate issued by the CA is in x.509 format.
- To use SSL/TLS communication, the Root Certificate from the CA must be installed on your computer. Contact your network administrator.



Related Information

- [Create a Certificate Signing Request \(CSR\) and Install a Certificate from a Certificate Authority \(CA\)](#)

Import and Export the Certificate and Private Key

Related Models: RJ-3235B/RJ-3255WB/RJ-4255WB

Store the certificate and private key on your machine and manage them by importing and exporting them.

- [Import a Certificate and Private Key](#)
- [Export the Certificate and Private Key](#)

Import a Certificate and Private Key

Related Models: RJ-3235B/RJ-3255WB/RJ-4255WB

Import the certificate and private key together in PKCS12 format.

1. Start your web browser.
2. Type "https://machine's IP address" in your browser's address bar (where "machine's IP address" is your machine's IP address).

For example:

https://192.168.1.2

You will find your machine's IP address in the Network Configuration Report.

3. If required, type the password in the **Login** field, and then click **Login**.



The default password to manage this machine's settings is located on the bottom of the machine and marked "**Pwd**". Change the default password by following the on-screen instructions when you first log in.

4. In the left navigation bar, click **Network > Security > Certificate**.



If the left navigation bar is not visible, start navigating from ☰.

5. Click **Import Certificate and Private Key**.
6. Browse and select to the file you want to import.
7. Type the password if the file is encrypted, and then click **Submit**.

The certificate and private key are imported to your machine.



Related Information

- [Import and Export the Certificate and Private Key](#)

Export the Certificate and Private Key

Related Models: RJ-3235B/RJ-3255WB/RJ-4255WB

1. Start your web browser.
2. Type "https://machine's IP address" in your browser's address bar (where "machine's IP address" is your machine's IP address).
For example:
https://192.168.1.2
You will find your machine's IP address in the Network Configuration Report.
3. If required, type the password in the **Login** field, and then click **Login**.



The default password to manage this machine's settings is located on the bottom of the machine and marked "**Pwd**". Change the default password by following the on-screen instructions when you first log in.

4. In the left navigation bar, click **Network > Security > Certificate**.



If the left navigation bar is not visible, start navigating from .

5. Click **Export** shown with **Certificate List**.
6. Enter the password if you want to encrypt the file.
If a blank password is used, the output is not encrypted.
7. Enter the password again for confirmation, and then click **Submit**.
8. Click **Save**.

The certificate and private key are exported to your computer.

You can also import the certificate to your computer.



Related Information

- [Import and Export the Certificate and Private Key](#)

Import and Export a CA Certificate

Related Models: RJ-3235B/RJ-3255WB/RJ-4255WB

You can import, export, and store CA certificates on your Brother machine.

- [Import a CA Certificate](#)
- [Export a CA Certificate](#)

Import a CA Certificate

Related Models: RJ-3235B/RJ-3255WB/RJ-4255WB

The CA certificate is in pem format. If the content is in pem format, you can use .crt, .cer, or .pem, whichever you prefer.

1. Start your web browser.
2. Type "https://machine's IP address" in your browser's address bar (where "machine's IP address" is your machine's IP address).

For example:

https://192.168.1.2

You will find your machine's IP address in the Network Configuration Report.

3. If required, type the password in the **Login** field, and then click **Login**.



The default password to manage this machine's settings is located on the bottom of the machine and marked "**Pwd**". Change the default password by following the on-screen instructions when you first log in.

4. In the left navigation bar, click **Network > Security > CA Certificate**.



If the left navigation bar is not visible, start navigating from ☰.

5. Click **Import CA Certificate**.
6. Browse to the file you want to import.
7. Click **Submit**.



Related Information

- [Import and Export a CA Certificate](#)

Export a CA Certificate

Related Models: RJ-3235B/RJ-3255WB/RJ-4255WB

1. Start your web browser.
2. Type "https://machine's IP address" in your browser's address bar (where "machine's IP address" is your machine's IP address).

For example:

https://192.168.1.2

You will find your machine's IP address in the Network Configuration Report.

3. If required, type the password in the **Login** field, and then click **Login**.



The default password to manage this machine's settings is located on the bottom of the machine and marked "**Pwd**". Change the default password by following the on-screen instructions when you first log in.

4. In the left navigation bar, click **Network > Security > CA Certificate**.



If the left navigation bar is not visible, start navigating from ☰.

5. Select the certificate you want to export and click **Export**.
6. Click **Submit**.



Related Information

- [Import and Export a CA Certificate](#)

Manage Multiple Certificates

Related Models: RJ-3235B/RJ-3255WB/RJ-4255WB

The multiple certificate feature allows you to use Web Based Management to manage each certificate installed on your machine. In Web Based Management, navigate to the **Certificate** or **CA Certificate** screen to view certificate content, delete, or export your certificates.

	Maximum Number of Certificates Stored on Brother Machine
Self-signed Certificate or Certificate Issued by a CA	5
CA Certificate	6

We recommend storing fewer certificates than allowed, reserving an empty spot in case of certificate expiration. When a certificate expires, import a new certificate into the reserved spot, and then delete the expired certificate. This ensures that you avoid configuration failure.



- When you use HTTPS/IPPS, or IEEE 802.1x, you must select which certificate you are using.
- When you use SSL for SMTP communications, you do not have to choose the certificate. The necessary certificate will be chosen automatically.



Related Information

- [Configure Certificates for Device Security](#)

Use SSL/TLS

Related Models: RJ-3235B/RJ-3255WB/RJ-4255WB

- [Introduction to SSL/TLS](#)
- [Manage Your Network Machine Securely Using SSL/TLS](#)
- [Print Documents Securely Using SSL/TLS](#)

Introduction to SSL/TLS

Related Models: RJ-3235B/RJ-3255WB/RJ-4255WB

Secure Socket Layer (SSL) or Transport Layer Security (TLS) is an effective method of protecting data sent over a local or wide area network (LAN or WAN). It works by encrypting data, such as a print job, sent over a network, so anyone trying to capture it will not be able to read it.

SSL/TLS can be configured on both wired and wireless networks and will work with other forms of security such as WPA keys and firewalls.



Related Information

- [Use SSL/TLS](#)
 - [Brief History of SSL/TLS](#)
 - [Benefits of Using SSL/TLS](#)

Brief History of SSL/TLS

Related Models: RJ-3235B/RJ-3255WB/RJ-4255WB

SSL/TLS was originally created to secure web traffic information, particularly data sent between web browsers and servers. SSL is now used with additional applications, such as Telnet, printer, and FTP software, in order to become a universal solution for online security. Its original design intentions are still being used today by many online retailers and banks to secure sensitive data, such as credit card numbers, customer records, etc.

SSL/TLS uses extremely high levels of encryption and is trusted by banks all over the world.



Related Information

- [Introduction to SSL/TLS](#)
-

Benefits of Using SSL/TLS

Related Models: RJ-3235B/RJ-3255WB/RJ-4255WB

The primary benefit of using SSL/TLS is to guarantee secure printing over an IP network by restricting unauthorised users from reading data sent to the machine. SSL's most important benefit is that it can be used to print confidential data securely. For example, a Human Resource (HR) Department in a large company may be printing wage slips on a regular basis. Without encryption, the data contained on these wages slips can be read by other network users. However, with SSL/TLS, anyone trying to capture the data will see a page of code and not the actual wage slip.



Related Information

- [Introduction to SSL/TLS](#)
-

Manage Your Network Machine Securely Using SSL/TLS

Related Models: RJ-3235B/RJ-3255WB/RJ-4255WB

- [Configure a Certificate for SSL/TLS and Available Protocols](#)
- [Access Web Based Management Using SSL/TLS](#)
- [Install the Self-signed Certificate for Windows Users as Administrator](#)

Configure a Certificate for SSL/TLS and Available Protocols

Related Models: RJ-3235B/RJ-3255WB/RJ-4255WB

Configure a certificate on your machine using Web Based Management before you use SSL/TLS communication.

1. Start your web browser.
2. Type "https://machine's IP address" in your browser's address bar (where "machine's IP address" is your machine's IP address).

For example:

https://192.168.1.2

You will find your machine's IP address in the Network Configuration Report.

3. If required, type the password in the **Login** field, and then click **Login**.



The default password to manage this machine's settings is located on the bottom of the machine and marked "**Pwd**". Change the default password by following the on-screen instructions when you first log in.

4. In the left navigation bar, click **Network > Network > Protocol**.



If the left navigation bar is not visible, start navigating from ☰.

5. Click **HTTP Server Settings**.
6. Select the certificate you want to configure from the **Select the Certificate** drop-down list.
7. Click **Submit**.
8. Click **Yes** to restart your print server.



Related Information

- [Manage Your Network Machine Securely Using SSL/TLS](#)

Access Web Based Management Using SSL/TLS

Related Models: RJ-3235B/RJ-3255WB/RJ-4255WB

To manage your network machine securely, use Web Based Management with the HTTPS protocol.



- To use HTTPS protocol, HTTPS must be enabled on your machine. The HTTPS protocol is enabled by default.
- You can change the HTTPS protocol settings using Web Based Management.

1. Start your web browser.
2. Type "https://Common Name" in your browser's address bar (where "Common Name" is the Common Name that you assigned to the certificate; this could be your IP address, node name, or domain name).
3. If required, type the password in the **Login** field, and then click **Login**.



The default password to manage this machine's settings is located on the bottom of the machine and marked "**Pwd**". Change the default password by following the on-screen instructions when you first log in.

4. You can now access the machine using HTTPS.



Related Information

- [Manage Your Network Machine Securely Using SSL/TLS](#)

Install the Self-signed Certificate for Windows Users as Administrator

Related Models: RJ-3235B/RJ-3255WB/RJ-4255WB

- The following steps are for Microsoft Edge. If you use another web browser, refer to your web browser's documentation or online help for instructions on how to install certificates.
- Make sure you have created your self-signed certificate using Web Based Management.

1. Right-click the **Microsoft Edge** icon, and then click **Run as administrator**.

If the **User Account Control** screen appears, click **Yes**.

2. Type "https://machine's IP address" in your browser's address bar (where "machine's IP address" is your machine's IP address).

For example:

https://192.168.1.2

You will find your machine's IP address in the Network Configuration Report.

3. If your connection is not private, click the **Advanced** button, and then continue to the web page.
4. If required, type the password in the **Login** field, and then click **Login**.



The default password to manage this machine's settings is located on the bottom of the machine and marked "**Pwd**". Change the default password by following the on-screen instructions when you first log in.

5. In the left navigation bar, click **Network > Security > Certificate**.



If the left navigation bar is not visible, start navigating from ☰.

6. Click **Export**.
7. To encrypt the output file, type a password in the **Enter password** field. If the **Enter password** field is blank, your output file will not be encrypted.
8. Type the password again in the **Retype password** field, and then click **Submit**.
9. Click the downloaded file to open it.
10. When the **Certificate Import Wizard** appears, click **Next**.
11. Click **Next**.
12. If required, type a password, and then click **Next**.
13. Select **Place all certificates in the following store**, and then click **Browse....**
14. Select the **Trusted Root Certification Authorities**, and then click **OK**.
15. Click **Next**.
16. Click **Finish**.
17. Click **Yes**, if the fingerprint (thumbprint) is correct.
18. Click **OK**.



Related Information

- [Manage Your Network Machine Securely Using SSL/TLS](#)

Print Documents Securely Using SSL/TLS

Related Models: RJ-3235B/RJ-3255WB/RJ-4255WB

- [Print Documents Using IPPS](#)

Print Documents Using IPPS

Related Models: RJ-3235B/RJ-3255WB/RJ-4255WB

To print documents securely with IPP protocol, use the IPPS protocol.

1. Start your web browser.
2. Type "https://machine's IP address" in your browser's address bar (where "machine's IP address" is your machine's IP address).

For example:

https://192.168.1.2

You will find your machine's IP address in the Network Configuration Report.

3. If required, type the password in the **Login** field, and then click **Login**.



The default password to manage this machine's settings is located on the bottom of the machine and marked "**Pwd**". Change the default password by following the on-screen instructions when you first log in.

4. In the left navigation bar, click **Network > Network > Protocol**.



If the left navigation bar is not visible, start navigating from ☰.

5. Make sure the **IPP** checkbox is selected.



If the **IPP** checkbox is not selected, select the **IPP** checkbox, and then click **Submit**.

Restart your machine to activate the configuration.

After the machine restarts, return to the machine's web page, type the password, and then in the left navigation bar, click **Network > Network > Protocol**.

6. Click **HTTP Server Settings**.
7. Select the **HTTPS** checkbox in the **IPP** area, and then click **Submit**.
8. Restart your machine to activate the configuration.

Communication using IPPS cannot prevent unauthorised access to the print server.



Related Information

- [Print Documents Securely Using SSL/TLS](#)

Use SNMPv3

Related Models: RJ-3235B/RJ-3255WB/RJ-4255WB

- [Manage Your Network Machine Securely Using SNMPv3](#)

Manage Your Network Machine Securely Using SNMPv3

Related Models: RJ-3235B/RJ-3255WB/RJ-4255WB

The Simple Network Management Protocol version 3 (SNMPv3) provides user authentication and data encryption to manage network devices securely.

1. Start your web browser.
2. Type "https://Common Name" in your browser's address bar (where "Common Name" is the Common Name that you assigned to the certificate; this could be your IP address, node name, or domain name).
3. If required, type the password in the **Login** field, and then click **Login**.



The default password to manage this machine's settings is located on the bottom of the machine and marked "**Pwd**". Change the default password by following the on-screen instructions when you first log in.

4. In the left navigation bar, click **Network > Network > Protocol**.



If the left navigation bar is not visible, start navigating from ☰.

5. Make sure the **SNMP** setting is enabled, and then click **Advanced Settings**.
6. Configure the SNMPv1/v2c mode settings.

Option	Description
SNMP v1/v2c read-write access	The print server uses version 1 and version 2c of the SNMP protocol. You can use all of your machine's applications in this mode. However, it is not secure since it will not authenticate the user and data will not be encrypted.
SNMP v1/v2c read-only access	The print server uses the read-only access of version 1 and version 2c of the SNMP protocol.
Disabled	Disable version 1 and version 2c of the SNMP protocol. All applications that use SNMPv1/v2c will be restricted. To allow the use of SNMPv1/v2c applications, use the SNMP v1/v2c read-only access or SNMP v1/v2c read-write access mode.

7. Configure the SNMPv3 mode settings.

Option	Description
Enabled	The print server uses version 3 of the SNMP protocol. To manage the print server securely, use the SNMPv3 mode, and then configure the settings.
Disabled	Disable version 3 of the SNMP protocol. All applications that use SNMPv3 will be restricted. To allow the use of SNMPv3 applications, use the SNMPv3 mode.

8. Click **Submit**.



If your machine displays the protocol setting options, select the options you want.

9. Restart your machine to activate the configuration.



Related Information

- [Use SNMPv3](#)

Use IEEE 802.1x Authentication for Your Network

Related Models: RJ-3235B/RJ-3255WB/RJ-4255WB

- [What Is IEEE 802.1x Authentication?](#)
- [Configure IEEE 802.1x Authentication Using Web Based Management \(Web Browser\)](#)
- [IEEE 802.1x Authentication Methods](#)

What Is IEEE 802.1x Authentication?

Related Models: RJ-3235B/RJ-3255WB/RJ-4255WB

IEEE 802.1x is an IEEE standard that limits access from unauthorised network devices. Your Brother machine sends an authentication request to a RADIUS server (Authentication server) through your access point or hub. After your request has been verified by the RADIUS server, your machine can access the network.



Related Information

- [Use IEEE 802.1x Authentication for Your Network](#)
-

Configure IEEE 802.1x Authentication Using Web Based Management (Web Browser)

Related Models: RJ-3235B/RJ-3255WB/RJ-4255WB

- If you configure your machine using EAP-TLS authentication, you must install the client certificate issued by a CA before you start configuration. Contact your network administrator about the client certificate. If you have installed more than one certificate, we recommend writing down the certificate name you want to use.
- Before you verify the server certificate, you must import the CA certificate issued by the CA that signed the server certificate. Contact your network administrator or your Internet Service Provider (ISP) to confirm whether a CA certificate import is necessary.

1. Start your web browser.
2. Type "https://machine's IP address" in your browser's address bar (where "machine's IP address" is your machine's IP address).

For example:

https://192.168.1.2

Your machine's IP address can be found in the Network Configuration Report.



- If you are using a Domain Name System or enable a NetBIOS name, you can type another name, such as "SharedPrinter" instead of the IP address.

For example: https://SharedPrinter

- If you enable a NetBIOS name, you can also use the node name.

For example: https://brn123456abcdef

- The NetBIOS name can be found in the Network Configuration Report.

Web Based Management appears.

3. If required, type the password in the **Login** field, and then click **Login**.



The default password to manage this machine's settings is located on the bottom of the machine and marked "**Pwd**". Change the default password by following the on-screen instructions when you first log in.

4. In the left navigation bar, click **Network**.



If the left navigation bar is not visible, start navigating from ☰.

5. Do one of the following:
 - For the wired network
Click **Wired** > **Wired 802.1x Authentication**.
 - For the wireless network
Click **Wireless** > **Wireless (Enterprise)**.
6. Configure the IEEE 802.1x authentication settings.



- To enable IEEE 802.1x authentication for wired networks, select **Enabled** for **Wired 802.1x status** on the **Wired 802.1x Authentication** page.
- If you are using **EAP-TLS** authentication, you must select the client certificate installed (shown with certificate name) for verification from the **Client Certificate** drop-down list.
- If you select **EAP-FAST**, **PEAP**, **EAP-TTLS**, or **EAP-TLS** authentication, select the verification method from the **Server Certificate Verification** drop-down list. Verify the server certificate using the CA certificate, imported to the machine in advance, issued by the CA that signed the server certificate.

Select one of the following verification methods from the **Server Certificate Verification** drop-down list:

Option	Description
No Verification	The server certificate can always be trusted. The verification is not performed.
CA Cert.	The verification method to check the CA reliability of the server certificate, using the CA certificate issued by the CA that signed the server certificate.
CA Cert. + ServerID	The verification method to check the common name ¹ value of the server certificate, in addition to the CA reliability of the server certificate.

7. When finished with configuration, click **Submit**.

For wired networks: After configuring, connect your machine to the IEEE 802.1x supported network. After a few minutes, print the Network Configuration Report to check the **<Wired IEEE 802.1x>** status.

Option	Description
Success	The wired IEEE 802.1x function is enabled and the authentication was successful.
Failed	The wired IEEE 802.1x function is enabled; however, the authentication failed.
Off	The wired IEEE 802.1x function is not available.

Related Information

- [Use IEEE 802.1x Authentication for Your Network](#)

Related Topics:

- [Configure Certificates for Device Security](#)
-

¹ The common name verification compares the common name of the server certificate to the character string configured for the **Server ID**. Before you use this method, contact your system administrator about the server certificate's common name and then configure **Server ID**.

IEEE 802.1x Authentication Methods

Related Models: RJ-3235B/RJ-3255WB/RJ-4255WB

EAP-FAST

Extensible Authentication Protocol-Flexible Authentication via Secured Tunneling (EAP-FAST) has been developed by Cisco Systems, Inc., which uses a user ID and password for authentication, and symmetric key algorithms to achieve a tunnelled authentication process.

Your Brother machine supports the following inner authentication methods:

- EAP-FAST/NONE
- EAP-FAST/MS-CHAPv2
- EAP-FAST/GTC

EAP-MD5 (Wired network)

Extensible Authentication Protocol-Message Digest Algorithm 5 (EAP-MD5) uses a user ID and password for challenge-response authentication.

PEAP

Protected Extensible Authentication Protocol (PEAP) is a version of EAP method developed by Cisco Systems, Inc., Microsoft Corporation and RSA Security. PEAP creates an encrypted Secure Sockets Layer (SSL)/Transport Layer Security (TLS) tunnel between a client and an authentication server, for sending a user ID and password. PEAP provides mutual authentication between the server and the client.

Your Brother machine supports the following inner authentication methods:

- PEAP/MS-CHAPv2
- PEAP/GTC

EAP-TTLS

Extensible Authentication Protocol-Tunneled Transport Layer Security (EAP-TTLS) has been developed by Funk Software and Certicom. EAP-TTLS creates a similar encrypted SSL tunnel to PEAP, between a client and an authentication server, for sending a user ID and password. EAP-TTLS provides mutual authentication between the server and the client.

Your Brother machine supports the following inner authentication methods:

- EAP-TTLS/CHAP
- EAP-TTLS/MS-CHAP
- EAP-TTLS/MS-CHAPv2
- EAP-TTLS/PAP

EAP-TLS

Extensible Authentication Protocol-Transport Layer Security (EAP-TLS) requires digital certificate authentication both at a client and an authentication server.



Related Information

- [Use IEEE 802.1x Authentication for Your Network](#)

Update

- [Update P-touch Editor](#)
- [Update the Firmware](#)

Update P-touch Editor

Before updating P-touch Editor, install the printer driver.

1. Start P-touch Editor .

Click **Start > Brother P-touch > P-touch Editor**, or double-click the **P-touch Editor** icon on the desktop.

NOTE

Depending on your computer's operating system, the Brother P-touch folder may or may not be created.

2. Click the **New Label** button to open the main window.
3. Click **Help > Check for Updates**.
4. If the update is available, a confirmation message will appear. Click **Download**.



Related Information

- [Update](#)

Update the Firmware

- Do not turn the power off or disconnect the cable when transferring data or updating firmware.
- If any other application is running, exit the application.

Before updating the firmware, you must first install the printer driver.

1. Turn the printer on and connect the USB cable.
2. Make sure your computer is connected to the Internet.
3. Start the P-touch Update Software.
Click **Start > Brother P-touch > P-touch Update Software**, or double-click the **P-touch Update Software** icon on the desktop.
4. Click the **Firmware update** icon.
5. Click the **Printer** drop-down list, select your printer, and then click **OK**.
6. Select **Language** from the drop-down list.
7. Select the checkbox next to the firmware you want to update, and then click **Transfer**.
8. Click **Start**.
The firmware update begins.

NOTE

You may need to re-establish Bluetooth connection after firmware updates. Delete the Bluetooth connection information, and perform pairing again.

✓ Related Information

- [Update](#)

Printer Settings

- [Change Printer Settings Using the BRConfiguration Tool \(Windows\)](#)
- [Change Printer Settings Using Web Based Management](#)
- [Confirm Printer Settings](#)
- [Change Printer Settings Using the Printer](#)

Change Printer Settings Using the BRConfiguration Tool (Windows)

To change printer settings including password, power settings including auto sleep and auto power off, and print settings such as print speed and print density, use the BRConfiguration Tool.

For more information about the BRConfiguration Tool, go to the *BRConfiguration Tool Guide* at support.brother.com/g/s/es/htmldoc/brconfiguration/eng/index.html.



Related Information

- [Printer Settings](#)
 - [The Paper Size Setup \(For Windows\)](#)

The Paper Size Setup (For Windows)

Use the Paper Size Setup feature to add paper sizes that are not available in the printer driver's **Paper Size** list. On your Windows PC, click **Start > Settings** and select your printer from the list of devices. Click **Printing Preferences > Paper Size Setup**.

Before printing on a new paper size, register the new size by sending it to your printer, following the instructions in this section.

Printing on a paper size that has not been registered may result in incorrect print output.

Paper Size Setup Dialog Box

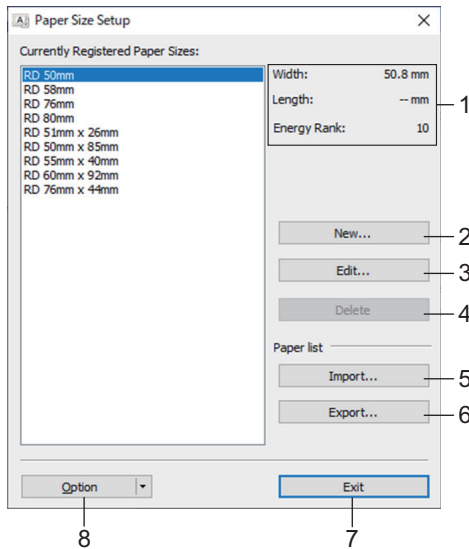

1. Current settings

Displays the current settings for the selected paper format.

2. New

Click this button to display the **New** dialog box and register a new paper size.

NOTE

Do not register a paper size already registered, to avoid incorrect print results. To use paper of the same size as one that is currently registered, select the size you want from the **Currently Registered Paper Sizes** list in the **Paper Size Setup** dialog box, and then change and overwrite the settings from the **Edit** dialog box.

3. Edit

Edits the settings for the selected paper format.

To save the selected paper format with the new settings, click **Overwrite**. To add a paper format with the new settings, change the name in the **Paper Size Name** box, and then click **Add**.

4. Delete

Deletes the selected paper format. A deleted paper format cannot be restored.

5. Import

Reads the text file containing the paper format settings and uses it to replace the contents of the **Currently Registered Paper Sizes** list.

NOTE

When the list is imported, the entire contents of the **Currently Registered Paper Sizes** list will be replaced with the imported paper formats.

6. Export

Exports the paper formats in the **Currently Registered Paper Sizes** list to a file. The exported formats can then be distributed to other computers.

7. Exit

Exits the **Paper Size Setup** window.

8. Option

Click ▼, and then select an operation.

Click **Register Paper Size With Printer** to register the settings for the selected paper format in the printer.

Click **Save in Command File** to export the paper settings as a command file. (The file extension is BIN.)

NOTE

When the paper format is registered with the printer and **Exit** is clicked, the **Paper Size Setup** dialog box appears with the added paper size in the **Currently Registered Paper Sizes** list. If the software is running, exit the software, and then restart it for the new paper format to appear in the list.



- If the following functions are being used, you can quickly apply their settings to the printer:
 - Mass storage feature
 - Bluetooth (Object Push Profile (OPP))
 - Wi-Fi (File Transfer Protocol (FTP)) (RJ-3255WB/RJ-4255WB)
- These commands are only intended to be used to apply settings to a printer. These commands cannot be imported into the Paper Size Setup.

>> [New Dialog Box](#)

>> [Advanced Printing Adjustments Dialog Box](#)

New Dialog Box

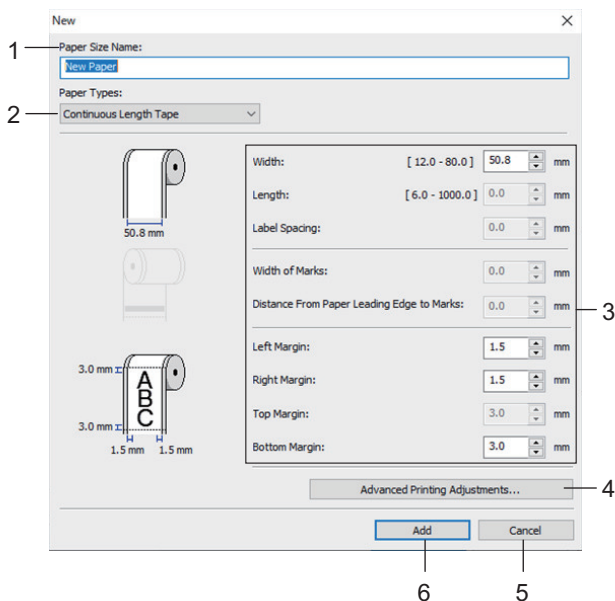

1. Paper Size Name

Type in the name of the paper format to be added.

2. Paper Types

Select the paper type.

3. Detailed settings

Specify details for the paper format to be added.

4. Advanced Printing Adjustments

Click this button to display the **Advanced Printing Adjustments** dialog box and make advanced printing adjustments for each paper format.

5. Cancel

Cancels the settings and closes the dialog box. The settings will remain unchanged.

6. Add

Click this button to add the paper format and apply the settings.

Advanced Printing Adjustments Dialog Box

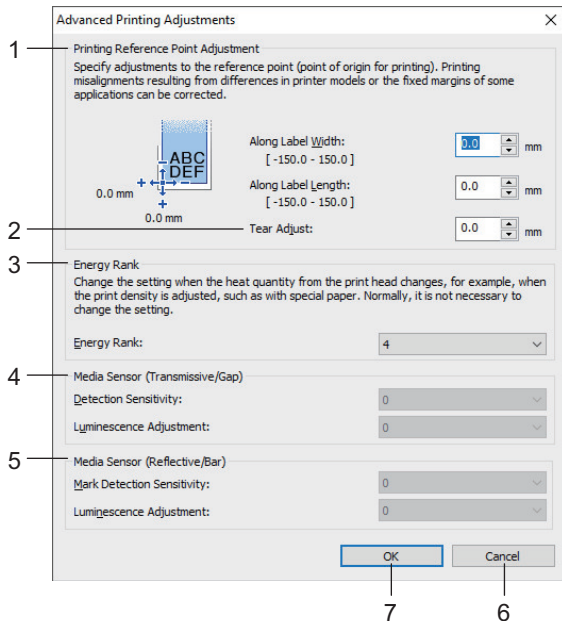

1. Printing Reference Point Adjustment

Adjust the position of the reference point (point of origin for printing). This corrects printing misalignments resulting from differences in printer models or from the fixed margins of some software.

2. Tear Adjust

Adjust the cutting position when the paper is cut using the Tear Bar.

3. Energy Rank

Adjust the amount of heat (energy) from the print head, for example, with special paper.



There may be contrast variations in the print result due to the operating environment and media used. Modify the settings as necessary.

4. Media Sensor (Transmissive/Gap)

Adjust the precision with which the transmissive/gap sensor detects the gaps (spacing) for die-cut labels and the amount of light emitted by the sensor.

Settings can be specified when **Paper Types** is set to **Die-cut Label**.



The settings for **Media Sensor (Transmissive/Gap)** in the **Device Settings** dialog box can influence the detection and calibration results. Make sure you specify the appropriate values.

Example settings:

	Setting EX1	Setting EX2
Device Settings	+2	-2
Paper Size Setup	+2	+2
Actual effect	4	0

5. Media Sensor (Reflective/Bar)

Adjust the precision with which the reflective/black mark sensor detects black marks and the amount of light emitted by the sensor.

Settings can be specified when **Paper Types** is set to **Media With Marks**.



The settings for **Media Sensor (Reflective/Bar)** in the **Device Settings** dialog box can influence the detection and calibration results. Make sure you specify the appropriate values.

Example settings:

	Setting EX1	Setting EX2
Device Settings	+2	-2
Paper Size Setup	+2	+2
Actual effect	4	0

6. Cancel

Cancels the settings and closes the dialog box. The settings will remain unchanged.

7. OK

Saves the settings and returns to the previous dialog box.



Related Information

- [Change Printer Settings Using the BRConfiguration Tool \(Windows\)](#)
 - [Distribute Paper Formats to Other Computers \(Windows\)](#)

Distribute Paper Formats to Other Computers (Windows)

The paper formats exported from the **Currently Registered Paper Sizes** list in the **Paper Size Setup** dialog box can be distributed to other computers. If the printer driver has been installed on the recipient's computer, only the paper formats need to be distributed.

1. At the sender's computer, specify the paper format settings, and then click **Export**.

The following files are created:

RJ-3235B	bsr3235ed.ptd bsr3235ed.txt pdt4737.bin
RJ-3255WB	bsr3255ed.ptd bsr3255ed.txt pdt4837.bin
RJ-4235B	bsr4235ed.ptd bsr4235ed.txt pdt4937.bin
RJ-4255WB	bsr4255ed.ptd bsr4255ed.txt pdt4A37.bin

2. Save the TXT file in any location on the recipient's computer.
3. At the recipient's computer, click **Import**.

The paper formats are replaced with the imported ones.



Related Information

- [The Paper Size Setup \(For Windows\)](#)

Change Printer Settings Using Web Based Management

Related Models: RJ-3235B/RJ-3255WB/RJ-4255WB

You can use a standard web browser to change your machine's settings using the Hyper Text Transfer Protocol (HTTP) or Hyper Text Transfer Protocol over Secure Socket Layer (HTTPS).

When using Web Based Management, the following operations are available:

- Displaying your machine status information
- Changing network settings, such as TCP/IP information
- Displaying the machine's software version information
- Changing network and machine configuration details



- We recommend Microsoft Edge for Windows. Make sure that JavaScript and Cookies are always enabled in whichever browser you use.
- The default login password to manage machine settings is located on your machine and marked "Pwd:". We recommend you change it to protect your machine from unauthorised access.

To use Web Based Management, your network must use TCP/IP, and the machine and computer must have a valid IP address.

1. Start your web browser.
2. Type "https://machine's IP address" in your browser's address bar.

For example:

https://192.168.1.2



- If you are using a Domain Name System or enable a NetBIOS name, you can type another name, such as "SharedPrinter" instead of the IP address.

For example:

https://SharedPrinter

If you enable a NetBIOS name, you can also use the node name.

For example:

https://brn123456abcdef

3. If required, type the password in the **Login** field, and then click **Login**.
4. Change the machine settings.

Every time you access Web Based Management, type the password in the **Login** field, and then click **Login**. After configuring the settings, click **Logout**.



Related Information

- [Printer Settings](#)
 - [Set or Change a Login Password for Web Based Management](#)

Set or Change a Login Password for Web Based Management

Related Models: RJ-3235B/RJ-3255WB/RJ-4255WB

We recommend changing the default login password to prevent unauthorised access to Web Based Management.

1. Start your web browser.
2. Type "https://machine's IP address" in your browser's address bar.

For example:

https://192.168.1.2



If you are using a Domain Name System or enable a NetBIOS name, you can type another name, such as "SharedPrinter" instead of the IP address.

For example:

https://SharedPrinter

If you enable a NetBIOS name, you can also use the node name.

For example:

https://brn123456abcdef

3. Do one of the following:
 - If you have previously set your own password, type it, and then click **Login**.
 - If you have not previously set your own password, type the password located on your machine and marked "Pwd", and then click **Login**.
4. Click the **Administrator** tab.
5. Type the password you want to use in the **Enter New Password** field (up to 32 characters).
6. Re-type the password in the **Confirm New Password** field.
7. Click **Submit**.



Related Information

- [Change Printer Settings Using Web Based Management](#)

Confirm Printer Settings

You can print a Printer Settings Report without connecting the printer to a computer or mobile device.

1. Turn the printer on.
2. RJ-3235B/RJ-3255WB: Load a 76 mm media into the printer.
3. RJ-4235B/RJ-4255WB: Load a 102 mm media into the printer.
4. Press and hold the  (Feed) / **OK** button.

The report starts printing.



The report indicates the model name, serial number, rechargeable Li-ion battery status, error history and more detailed information on the printer's configuration and parameter settings.



The printout displays the following sections:

- [Printer]:** Model (RJ-3235B), Serial No., Firmware Ver., etc.
- [Battery Status]:** Battery Voltage, Temperature, Charge Cycle, etc.
- [Error History]:** List of error events with timestamps and descriptions.
- [Database List]:** List of stored files with names and sizes.
- [Font List]:** List of installed fonts.
- [Printer Settings]:** Configuration for touch templates, print speed, paper size, etc.
- [Firmware]:** Version and update information.
- [Bluetooth]:** Device name, address, and pairing status.
- [WAN]:** Network settings including MAC address, IP, and DNS.

Related Information

- [Printer Settings](#)

Change Printer Settings Using the Printer

1. Press the **Menu** / ▼ (Select) button to select the menu option, and then press the  (Feed) / **OK** button.
2. Press the **Menu** / ▼ (Select) button to select an option, and then press the  (Feed) / **OK** button. .



- a. The current selection is highlighted.
- b. The scroll bar shows the position of the highlighted option on the list.

 You can also change the printer settings using the BRConfiguration Tool on a computer connected to the printer.

Related Information

- [Printer Settings](#)
 - [Settings Tables](#)

Related Topics:

- [Change Printer Settings Using the BRConfiguration Tool \(Windows\)](#)

Settings Tables

The Settings tables describe the menu selections and options.



Some settings may differ depending on the firmware (printer software) version.

>> [WLAN] (RJ-3255WB/RJ-4255WB)

>> [Bluetooth]

>> [Media]

>> [Settings]

>> [Admin Menu]

[WLAN] (RJ-3255WB/RJ-4255WB)

Level 1	Level 2	Descriptions
On/Off	On / Off	Turn the WLAN function on or off.
Mode	Direct / Infrastructure / Direct/Infra	Select the network mode when you set the WLAN function to on.
WPS	Button Push / PIN Code	Select the WPS network settings method.
IP Address		Display the IP Address.

[Bluetooth]

Level 1	Level 2	Descriptions
On/Off	On / Off	Turn the Bluetooth function on or off.
Mode	Classic & LE / Classic / Low Energy	Select the Bluetooth mode.
AutoReconnect	On / Off	Switch to Automatic Reconnection mode (only for Apple devices: iPad, iPhone, or iPod touch).
Clear History		Delete the information for auto re-paired devices registered in the printer.
Confirm Code	On / Off	Select whether to perform confirmation during Bluetooth pairing.
Security Mode	Standard Mode / Secure Mode	Select the security mode for Bluetooth connection.
BT Address		Display the Bluetooth address.
Print Barcode		Print the Bluetooth address and corresponding barcode.

[Media]

Level 1	Level 2	Descriptions
Select Media	-	Select the paper size and paper type or check the current paper size setting. The list contains: <ul style="list-style-type: none"> • Default media (Nine types. Default: 76 mm x 44 mm) • User-defined media (Ten types) • Auto-detected media • Media settings obtained using the Auto Detect function.
Auto Detect	-	Automatically adjust the sensor sensitivity and detect the length of the set paper. Specify Settings in advance.
Settings ¹	-	Configure the settings before performing Auto Detect.

Level 1	Level 2	Descriptions
Settings ¹	Width	Select the paper width to be auto-detected.
	Sensor Type	Select the sensor type: Die-cut, Mark, or Continuous.
	Sensor Calibr	Enable or disable sensor calibration during auto-detection.
	Media Timeout	Set the auto-detected paper to Continuous if Auto Detect does not find any gap or black mark according to the Media Timeout length.
	Energy Rank	Select the energy rank to adjust the print density.

¹ Requires from the firmware version 1.09 or later.

[Settings]

Level 1	Level 2	Descriptions
Exit Position (RJ-3235B/ RJ-3255WB)	Tear / Peeler	Select the media exit method.
Language	Dansk / Deutsch / English / Español / Français / Italiano / Nederlands / Norsk / Português / Suomi / Svenska / 日本語	Select the language.
LCD Contrast	+2 / +1 / 0 / -1 / -2	Set the contrast of the LCD. The higher the number, the stronger the contrast.
Beeper	On / Off	Enable or disable the beeper.
Eco Charging	100% / 80%	Charging settings
Configuration		Check the firmware version, font version, and available memory.
Tear Bar	Upward / Downward	Adjust the tear position. This setting appears when the Linerless is set to Off in the Advanced tab of the BRConfiguration Tool.
Cover Setting ¹	Select Media	Shows the Select Media screen for ten seconds after you close the Roll Compartment Cover.
	Feed	Feeds the label automatically when you close the Roll Compartment Cover.
	Auto Detect	Performs Auto Detect automatically when you close the Roll Compartment Cover. The printer displays the detected paper size, and then displays the Ready screen.
	None	No action and no change on the LCD.
Clock	On / Off	Show or hide the clock icon on the LCD.
AutoSync Time	On / Off	This setting appears when Clock is set to On.
Time Zone		Set the time zone. This setting appears when Clock is set to On.
Date&Time		Display the date and time. This setting appears when Clock is set to On.

¹ Requires from the firmware version 1.09 or later.

[Admin Menu]

Level 1	Level 2	Descriptions
Menu Lock	Update (RJ-3235B/ RJ-3255WB/ RJ-4255WB)	Select the checkboxes for any options you want to prevent changes from the printer's LCD. After selecting the checkboxes, press the Menu / ▼ (Select) button to select Finish , and then press the  (Feed) / OK button to complete the settings.
	WLAN (RJ-3255WB/ RJ-4255WB)	If the Menu Locks are set, the selected options would not be displayed on the LCD.
	Bluetooth	
	Wired LAN (RJ-3235B/ RJ-3255WB)	
	Media	
	Settings	
	Finish	
Menu Security	On / Off	Select if a passcode is required to enter the Administration mode. When set to on, specify the four-digit password.
Dump Mode	Start / Back	Print information on data received to date.
Web Admin	On / Off	Select whether to use Web Based Management.



Related Information

- [Change Printer Settings Using the Printer](#)

Routine Maintenance

- [Maintenance](#)

Maintenance

Maintenance of the printer may be carried out as required. However, some environments may require more frequent maintenance (for example, dusty environments).

- >> [Clean the Printer \(Exterior\)](#)
- >> [Clean the Print Head](#)
- >> [Clean the Roller](#)
- >> [Clean the Paper Exit Slot](#)
- >> [Linerless Platen Maintenance](#)
- >> [Label Peeler Maintenance \(RJ-3235B/RJ-3255WB\)](#)

Clean the Printer (Exterior)

Wipe any dust and marks from the printer's exterior using a soft, dry cloth. Use a cloth slightly damp with water on difficult to remove marks.

IMPORTANT

Do not use paint thinner, benzene, alcohol, or any other organic solvent. These may deform or damage the printer.

Clean the Print Head

Wipe the print head with a lint-free cloth dipped in isopropyl alcohol or ethanol. Carry out the maintenance frequently.

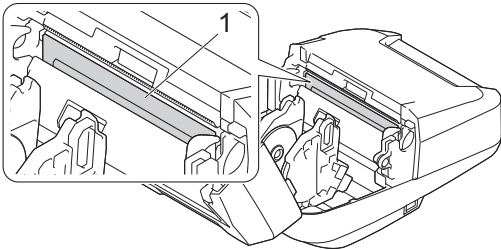

1. Print Head



Use the isopropyl alcohol or ethanol according to the manufacturer's safety guidelines, as applicable.

Clean the Roller

Wipe the roller with a lint-free cloth dipped in isopropyl alcohol or ethanol. After cleaning the roller, make sure that no lint or other material remains on the roller.

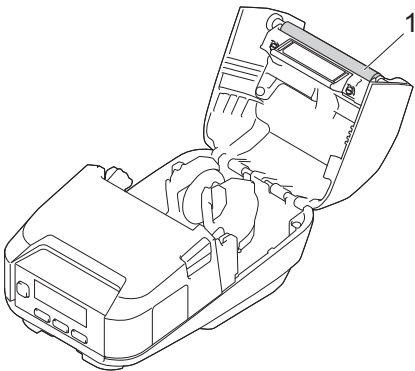

1. Roller



Use the isopropyl alcohol or ethanol according to the manufacturer's safety guidelines, as applicable.

Clean the Paper Exit Slot

If adhesive accumulates at the paper exit slot and media becomes jammed, or if the paper exit slot becomes dirty, wipe the paper exit slot with a lint-free cloth dipped in isopropyl alcohol or ethanol.

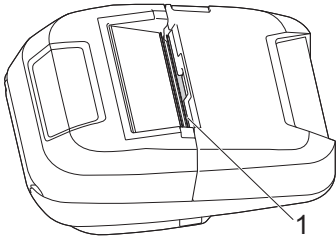

1. Paper Exit Slot



Use the isopropyl alcohol or ethanol according to the manufacturer's safety guidelines, as applicable.

Linerless Platen Maintenance

- RJ-3235B/RJ-3255WB:
When using the Linerless Platen Kit (PA-LPR-004), paper dust may stick to the print head.
- RJ-4235B/RJ-4255WB:
When using the Linerless Platen Kit (PA-LPR-001), paper dust may stick to the print head.

Clean the print head regularly with a lint-free cloth or cotton swab dipped in isopropyl alcohol or ethanol as shown in the illustration.

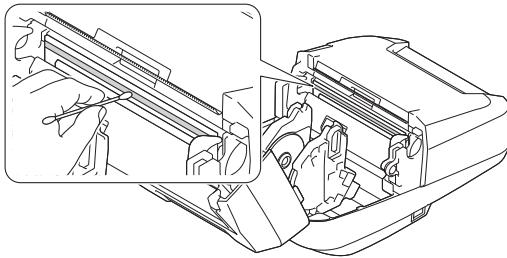

After cleaning the print head, make sure that no lint or other material remains on the print head.



-
- Do not clean the roller of the Linerless Platen to prevent its deterioration.
 - Use the isopropyl alcohol or ethanol according to the manufacturer's safety guidelines, as applicable.
-

Label Peeler Maintenance (RJ-3235B/RJ-3255WB)

When using the Label Peeler (PA-LP-007), adhesive may accumulate at the slot and roller parts, resulting in a media jam, or the slot and roller parts may become dirty.

Wipe the paper exit slot, peeler roller, and platen roller with a lint-free cloth dipped in isopropyl alcohol or ethanol as shown in the illustration.

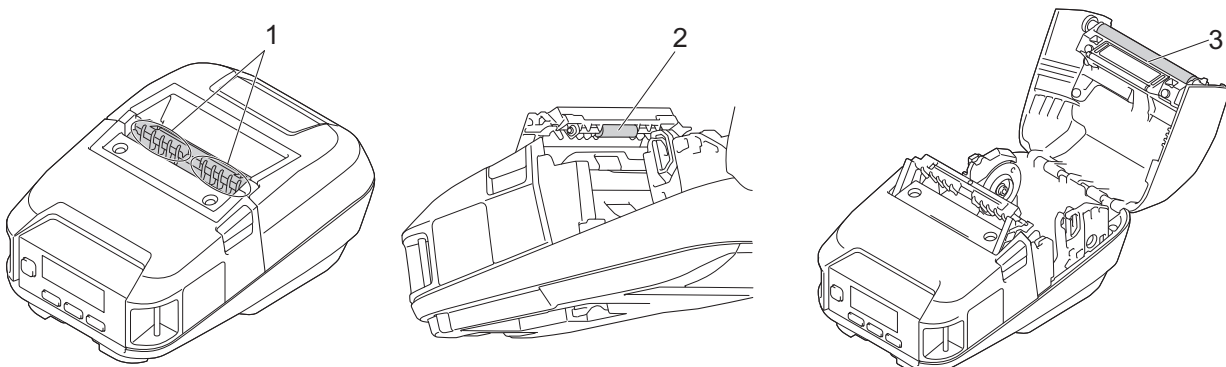

1. Paper Exit Slot
2. Peeler Roller

3. Platen Roller



Use the isopropyl alcohol or ethanol according to the manufacturer's safety guidelines, as applicable.



Related Information

- [Routine Maintenance](#)
-

Troubleshooting

- [If You Are Having Difficulty with Your Machine](#)
- [Error and Maintenance Messages](#)
- [Printing Problems](#)
- [Network Problems](#)
- [Version Information](#)
- [Reset the Printer](#)
- [Battery Charger \(Optional\) Problems](#)
- [Charging Cradle \(Optional\) Problems](#)
- [Linerless Platen Kit \(Optional\) Problems](#)

If You Are Having Difficulty with Your Machine

This chapter explains how to resolve typical problems you may encounter when using the printer. If you have any problems with the printer, first make sure you have performed the following tasks correctly:

- Connect the printer to a computer using a USB cable or install the rechargeable Li-ion battery.
- Connect the AC Adapter (Optional). For more information, see *Related Information*.
- Connect the Car Adapter (Optional). For more information, see *Related Information*.
- Remove all protective packaging from the printer.
- Install and select the correct printer driver. For more information, see *Related Topics*.
- Connect the printer to a computer or mobile device. For more information, see *Related Information*.
- Close the Roll Compartment Cover completely.
- Insert the media correctly. For more information, see *Related Information*.

If you still have problems, see *Related Information*. If after reading the topics you are unable to resolve the problem, visit the Brother support website at support.brother.com.



Related Information

- [Troubleshooting](#)

Related Topics:

- [Charge the Rechargeable Li-ion Battery](#)
- [Install the Rechargeable Li-ion Battery](#)
- [Connect Using a USB Cable](#)
- [Connect the Printer to a Mobile Device Using NFC \(Android\)](#)
- [Load the Roll](#)

Error and Maintenance Messages

Error Message	Cause/Solution
Batt.VeryPoor Replace battery	The rechargeable Li-ion battery may be depleted. Replace the rechargeable Li-ion battery with a new one. Visit the Brother support website at support.brother.com .
Cannot Update Data Try updating the data again.	Data acquisition has been unsuccessful when using Remote Update function or the specified file does not exist. <ul style="list-style-type: none"> • Check the FTP server setting of Remote Update function. • Make sure the setting file is stored in the specified location. • Make sure the update file is available that is specified in the setting file.
ChargingError Cannot Charge	Is rechargeable Li-ion battery charging incomplete despite continuous charging? Confirm that the rechargeable Li-ion battery is correctly installed. If charging is still unsuccessful, the rechargeable Li-ion battery may be deteriorated. Replace the rechargeable Li-ion battery with a new one.
Clock Not Set	Set the date and time.
Communication Error	<ul style="list-style-type: none"> • Data transfer has been unsuccessful. When sending a template as a BLF file, make sure the model name listed in the file matches your printer's model name. • Has the Wi-Fi or Bluetooth connection been interrupted? Turn the printer off, and then turn it on again.
Cover Open Close Cover	Is the Roll Compartment Cover open? Check that the Roll Compartment Cover is closed.
High Temp!	Is the printer temperature too high? When the Linerless rolls setting is active and the printer overheats, the error message appears. Wait until the printer cools down.
Invalid Database Record	An error will occur when printing a template which specifies an incorrect key code, or a non-existent key code in a linked database.
Mass Storage Operation error!	Is the printer in mass storage mode? <ul style="list-style-type: none"> • The printer's file system may be corrupted, or a file's name or contents were changed while the file was being transferred or processed. Turn the printer off, and then turn it on again. • Do not access the files on the printer during mass storage processing to avoid further problems.
Media Error! Check Loading	<ul style="list-style-type: none"> • Is the correct roll installed? Check that the correct media type (die-cut label or continuous length tape) and size is installed. • Is the roll installed correctly? If not, remove the roll, and then reinstall it. For more information, see <i>Related Topics</i>. • Is there enough roll remaining? If not, install a new roll.
Memory Full!	Make sure the data you transfer does not exceed the capacity of the user storage area.
No Template Selected	<ul style="list-style-type: none"> • There is no template with the specified number. Specify the correct number. • When printing a template, an error is indicated if the specified template does not exist. • The template was not transferred. Register the template with the specified number to the printer.

Error Message	Cause/Solution
Recharge Battery!	<p>Does the rechargeable Li-ion battery have a low charge?</p> <p>Use the AC Adapter and AC power cord to connect the printer to an electrical socket, or use the car adapter to connect the printer to a DC power socket to charge the rechargeable Li-ion battery.</p> <p>You can also charge the rechargeable Li-ion battery using a USB cable (not included).</p>
System Error! XX	If the error message is displayed, contact Brother customer service.
<p>WPS did not connect 1 Try to connect again</p> <p>WPS did not connect 2 Try to connect again</p>	<p>The Wi-Fi router/access point could not be found or multiple Wi-Fi routers/access points were found.</p> <ul style="list-style-type: none"> • Confirm that only one Wi-Fi router/access point within range has the WPS method active and try again. • Try again after a few minutes to avoid interference from other routers/access points.



Related Information

- [Troubleshooting](#)



Related Topics:

- [Load the Roll](#)

Printing Problems

- >> Printing Problems
- >> Printed Image Problems
- >> Printer Problems

Printing Problems

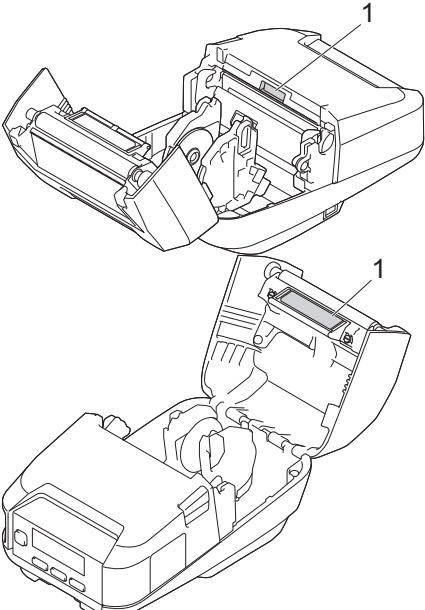

Problem	Solution
<p>The printer does not print, or there is a printing error.</p>	<ul style="list-style-type: none"> • Is the cable not fully connected (when you are using a USB cable)? Make sure the cable is connected securely. • Is the roll installed correctly? If not, remove the roll and reinstall it. For more information, see <i>Related Topics</i>. • Is there enough roll remaining? If not, install a new roll. • Is the Roll Compartment Cover open? Make sure the Roll Compartment Cover is closed. • Has a print error or transmission error occurred? Turn the printer off, and then turn it on again. If there is still a problem, contact Brother customer service.
<p>The printer does not feed paper.</p>	<ul style="list-style-type: none"> • Is there dirt or lint on the roller preventing it from rotating freely? Clean the roller. For more information, see <i>Related Topics</i>. • Make sure the ejection path of the paper is not blocked. • Remove the roll and install it again. For more information, see <i>Related Topics</i>. • Make sure the Roll Compartment Cover is closed completely.
<p>The printer feeds paper continuously.</p>	<ul style="list-style-type: none"> • Open the Roll Compartment Cover. • Press the  (Power) button or  (Back) button to cancel the print job. • Turn the printer off.
<p>The printer does not pause between labels.</p>	<ul style="list-style-type: none"> • Make sure you entered the media information correctly. You can set the media information using Paper Size Setup. • If the sensor is dirty, wipe it with a dry cotton swab. 

Problem	Solution
	<ol style="list-style-type: none"> Media Sensor <ul style="list-style-type: none"> Make sure there are no items blocking the sensor.
When printing via the USB cable, the printer repeatedly pauses, and then continues printing.	<p>Is the printer set for sequential printing? If so, set print mode to buffered printing.</p> <ul style="list-style-type: none"> Windows 10/Windows Server 2016/Windows Server 2019/Windows Server 2022: Click Start > Settings > Devices > Printers & scanners. Click the printer you want to set up, and then click Open queue. Click Printer > Printing Preferences. Click the Other tab and select the After one page of data is received option. Windows 8.1/Windows Server 2012/Windows Server 2012 R2: Click Control Panel in the Apps screen. Click Hardware and Sound > Devices and Printers. Right-click the printer you want to set up, and then click the Printing preferences menu. Click the Other tab and select the After one page of data is received option. Windows 7: Click Start > Devices and Printers. Right-click the printer you want to set up, and then click the Printing preferences menu. Click the Other tab and select the After one page of data is received option.
An error occurs when the roll cannot be fed to the print start position.	If a feed error occurs, use the Paper Size Setup to assign the correct paper settings to the printer or click <i>Select Media</i> to check whether correct media is set in the printer.

Printed Image Problems

Problem	Solution
Printed paper contains streaks or poor quality characters, or paper is not fed correctly.	<p>Is the print head or roller dirty?</p> <p>Although the print head generally remains clean under normal use, lint or dirt from the roller may become stuck on the printer head. If this occurs, clean the roller. For more information, see <i>Related Topics</i>.</p>
The print quality is poor.	<ul style="list-style-type: none"> Is there dust or dirt on the print head or roller preventing it from rotating freely? Clean the print head or roller. For more information, see <i>Related Topics</i>. Adjust the printing density. The print density can be specified in the BRConfiguration Tool.
Printed barcodes cannot be read.	<ul style="list-style-type: none"> Print labels so that barcodes are aligned with the print head as shown below: <div data-bbox="874 1615 1198 1776" data-label="Diagram"> <p>The diagram illustrates the correct alignment for printing barcodes. It shows a horizontal print head (labeled 1) positioned above a label. The label contains a barcode (labeled 2). A vertical arrow (labeled 3) points downwards from the print head to the barcode, indicating the printing direction. The barcode is centered under the print head.</p> </div> <ol style="list-style-type: none"> Print Head Barcodes Printing orientation Try using another barcode reader. Set Print Speed to a slower option. The print speed can be specified in the BRConfiguration Tool. For more information, see <i>Related Topics</i>. Adjust Print Density. The print density can be specified in the BRConfiguration Tool. For more information, see <i>Related Topics</i>. Always check that barcode labels can be read by the barcode reader.

Printer Problems

Problem	Solution
The LED indicator or the LCD is not lit.	<ul style="list-style-type: none"> Is the rechargeable Li-ion battery inserted correctly? Make sure the rechargeable Li-ion battery is inserted correctly. If it is, check that the rechargeable Li-ion battery has sufficient charge remaining. Is the adapter cord securely connected? Make sure the cord is connected correctly. If the LED Indicator or the LCD still does not light up, contact Brother customer service.
A data transmission error appears on the computer.	<ul style="list-style-type: none"> Is the correct port selected? Make sure the correct port is selected. Is the printer in cooling mode? The message <code>Cooling</code> appears on the LCD. Wait until the message disappears and then try printing again. Are there any unfinished print jobs? If you try to print while other users are printing large amounts of data, the printer is unable to accept your print job until the current print jobs are completed. If this occurs, send the print job again after the other jobs are completed.
I want to reset the printer/delete the data transferred from the computer.	See <i>Related Topics</i> .
I want to cancel the current print job.	Make sure that the printer is On, and then press the  (Power) button or  (Back) button.
Print head, motor, or rechargeable Li-ion battery is too hot.	<ul style="list-style-type: none"> Head: If the print head becomes too hot, it may produce imaging on the paper in areas not intended to be printed. This condition is normal when printing documents with a lot of “black” content. The printer will stop and resume printing after the print head has cooled down. To avoid or delay this condition, print using a lighter density setting, reduce the amount of black space being printed (for example, remove background shading and colors in graphs and presentation documents), and make sure that the printer has adequate ventilation and is not located in an enclosed space. Motor or rechargeable Li-ion battery: Do not use the printer continuously. If the printer is used continuously, the motor or rechargeable Li-ion battery will become too hot. In this case, the printer will stop and resume printing after the motor or rechargeable Li-ion battery has cooled down.
Transferring the program failed.	The system will recover if the program is transferred again. To resolve the issue, contact your Brother dealer or Brother customer service for assistance.

Related Information

- [Troubleshooting](#)



Related Topics:

- [Load the Roll](#)
- [Reset the Printer](#)
- [Change Printer Settings Using the BRConfiguration Tool \(Windows\)](#)

Network Problems

- >> [Network Setup Problems](#)
- >> [Cannot Print over the Network / Printer Is Not Found on the Network Even after Successful Installation](#)
- >> [Security Software Problems](#)
- >> [Check the Operation of Network Devices](#)

Network Setup Problems

Problem	Solution
You are using security software	<ul style="list-style-type: none"> • Confirm your settings in the printer driver installer dialog box. • Allow access when the security software alert message appears during the printer driver installation.
Your security settings (SSID/Network Key) are incorrect	<p>Make sure the network security settings are correct:</p> <ul style="list-style-type: none"> • See the instructions supplied with your Wi-Fi router/access point for information on how to find the security settings. • The default SSID (Network Name) may be your Wi-Fi router/access point's manufacturer name or model number. • Contact the manufacturer of your Wi-Fi router/access point or ask your Internet provider or network administrator.
The printer cannot connect to the mobile device using Wi-Fi or Bluetooth.	<ul style="list-style-type: none"> • Move the printer within about one metre of the mobile device when you configure the Wi-Fi network settings. • Move the printer to an obstruction-free area. • If a wireless computer, Bluetooth-equipped device, microwave oven, digital cordless phone, or other device is near the printer or the Wi-Fi router/access point, move the device away from the printer or Wi-Fi router/access point.
The printer cannot print using Wi-Fi or Bluetooth.	
Your Wi-Fi access point/router is in stealth mode (not broadcasting the SSID)	<ul style="list-style-type: none"> • Enter the correct SSID name during the installation or when using Communication Settings in the BRConfiguration Tool. • Check the SSID name in the instructions supplied with your Wi-Fi router/access point and set up your wireless network again.
The printer is not connected correctly to the network.	<p>Check the WLAN icon on the LCD.</p> <div style="display: flex; align-items: flex-start;"> <div style="margin-right: 20px;">  </div> <div> <p>: The printer is already connected to a wireless network. Check the wireless network information and connect your Wi-Fi router/access point correctly.</p> </div> </div> <div style="display: flex; align-items: flex-start; margin-top: 10px;"> <div style="margin-right: 20px;">  </div> <div> <p>: The printer is searching for the network. Make sure the Wi-Fi router/access point is available and wait a while. If the printer is still not connected, set up the printer's Wi-Fi connection again.</p> </div> </div> <p>No icon</p> <p>: The wireless network feature on your printer is off. Make sure that the printer is in the mode you want to use to connect.</p>
I have checked and tried all of the above, but still cannot complete the wireless configuration.	Turn the printer off, and then turn it on again. Then try to configure the Wi-Fi settings again.

Cannot Print over the Network / Printer Is Not Found on the Network Even after Successful Installation

Problem	Solution
You are using security software	For more information, see <i>Related Topics</i> .

Problem	Solution
The printer is not assigned with an available IP address	<ul style="list-style-type: none"> Confirm the IP address and the Subnet Mask. Verify that both the IP addresses and Subnet Masks of your computer and the printer are correct and located on the same network. For more information on how to verify the IP address and the Subnet Mask, contact your network administrator. Confirm your IP address, Subnet Mask and other network settings in Communication Settings in the BRConfiguration Tool. For more information, see <i>Related Topics</i>.
Your previous printing job failed.	<p>If the failed printing job is still in your computer's print queue, delete it. For example, when using Windows 10:</p> <p>Click Start > Settings > Devices > Printers & scanners. Click your printer, and then click Open queue. Click Printer > Cancel All Documents</p>
I have checked and tried all the above, but my printer does not print.	Uninstall the printer driver and software, and then reinstall them.

Security Software Problems

Problem	Solution
You did not choose to allow access when the security alert dialog box appeared during either the standard installation or when printing.	If you did not choose to accept the security alert dialog box, the firewall function of your security software may be rejecting access. Some security software may block access without showing a security alert dialog box. To allow access, see the instructions of your security software or contact the manufacturer.
Incorrect port numbers are being used for the Brother network features	<p>The following port number is used for Brother network features: BRAdmin Professional: Port number 161 / Protocol UDP</p> <p>For more information about how to open the port, see the instructions for the security software or contact its manufacturer.</p>

Check the Operation of Network Devices

Problem	Solution
The printer and Wi-Fi router/access point are not turned on.	Make sure you have confirmed all the instructions listed in the Related Information topics.
I do not know my printer's network settings, such as the IP address.	Check Communication Settings in the BRConfiguration Tool. For more information, see <i>Related Topics</i> .

✓ Related Information

- [Troubleshooting](#)

Related Topics:

- [Change Printer Settings Using the BRConfiguration Tool \(Windows\)](#)

Version Information

Problem	Solution
I do not know the current version of the printer's firmware.	You can confirm the version number of the firmware by printing the configuration report.
I want to confirm whether I am using the latest version of the software.	Windows Use the P-touch Update Software to confirm whether you have the latest version. For more information, see <i>Related Topics</i> : Update P-touch Editor.



Related Information

- [Troubleshooting](#)







Related Topics:

- [Update P-touch Editor](#)

Reset the Printer

Reset the internal memory of your printer to clear all the saved label files, or if the printer is not operating correctly.

You can reset settings on the printer.

1. Press the  (Power) button to turn the printer off.
2. Press and hold the  (Power) button and the  (Feed) / **OK** button for about five seconds.
3. While holding the  (Power) button, press the  (Feed) / **OK** button as follows:
 - Two times: Reset the network settings
 - Four times: Reset the printer and user settings
 - Six times: Reset all settings to their factory settings
4. Release the  (Power) button.



Related Information

- [Troubleshooting](#)

Related Topics:

- [Change Printer Settings Using the BRConfiguration Tool \(Windows\)](#)

Battery Charger (Optional) Problems

If you experience any problems that you cannot resolve, contact your Brother dealer or Brother customer service for assistance.

Problem	Solution
The Charge Indicator turned off, but the rechargeable Li-ion battery has not fully charged.	Charging stopped because the rechargeable Li-ion battery became too hot or too cold. Wait and try charging the rechargeable Li-ion battery later.
The Charge Indicator flashes in orange.	An error occurred during charging. <ul style="list-style-type: none">• Wipe the Charging Terminals of the charger and the rechargeable Li-ion battery with a dry cloth.• Replace the rechargeable Li-ion battery with a new one.• Wait and try charging the rechargeable Li-ion battery later.



Related Information

- [Troubleshooting](#)

Charging Cradle (Optional) Problems

If you experience any problems that you cannot resolve, contact your Brother dealer or Brother customer service for assistance.

Problem	Solution
The Charging LED turned off, but the rechargeable Li-ion battery has not fully charged.	Charging stopped because the rechargeable Li-ion battery became too hot or too cold. Wait and try charging the rechargeable Li-ion battery later.
The Charging LED flashes in red.	<ul style="list-style-type: none">• The rechargeable Li-ion battery is not charged. Make sure the AC Adapter is plugged into the Charging Cradle.• Wipe the Charging Cradle Terminals of the Charging Cradle and the rechargeable Li-ion battery with a dry cloth.• Replace the rechargeable Li-ion battery with a new one.
The printer does not turn on when placed on the Charging Cradle.	<ul style="list-style-type: none">• Place the printer on the Charging Cradle correctly.• Make sure that the AC Adapter is correctly connected.• Reconnect the AC Adapter.
The printer does not print via LAN cable. (RJ-3235B/RJ-3255WB)	<ul style="list-style-type: none">• Place the printer on the Charging Cradle correctly.• Connect the LAN cable correctly.• Select the correct driver in the Devices and Printers. If the Charging Cradle is connected, your operating system will also display a copy of the printer driver icon (for example: Brother RJ-:****WB (Copy 1)) in the Devices and Printers. Make sure it is not selected.
The printer does not print via USB cable. (RJ-4235B/RJ-4255WB)	<ul style="list-style-type: none">• Place the printer on the Charging Cradle correctly.• Connect the USB cable correctly.• If USB cables are connected to the printer and the Charging Cradle simultaneously, disconnect the one connected to the printer, turn off the printer and turn on again.• RJ-4255WB: Select the correct driver in the Devices and Printers. If the Charging Cradle is connected, your operating system will also display a copy of the printer driver icon (for example: Brother RJ-:****WB (Copy 1)) in the Devices and Printers. Make sure it is not selected.



Related Information

- [Troubleshooting](#)

Linerless Platen Kit (Optional) Problems

Problem	Solution
The print quality is poor.	<ul style="list-style-type: none">• Install the Linerless Platen Kit correctly.• Clean the print head.
The printer does not feed paper.	<ul style="list-style-type: none">• Install the Linerless Platen Kit correctly.• Set the roll correctly.• Check if a label or adhesive has stuck under the Roll Compartment Cover. If so, clean the inside of the cover.
The media is jammed.	<p>Check the following points. If the printer still remains jammed, replace the Linerless Platen Kit.</p> <ul style="list-style-type: none">• Install the Linerless Platen correctly.• Wipe any adhesive residue left along the ejection path of the paper.• Clean the Roll Compartment and the Media Roll Holders.• The roll's adhesive may be too strong. Try using a different roll (with less adhesive).



Related Information

- [Troubleshooting](#)

Appendix

- [Specifications](#)
- [Software Development Kit](#)
- [LabelCLT](#)
- [Optional Accessories](#)
- [Product Dimensions](#)
- [Brother Help and Customer Support](#)
- [Compatible Operating Systems](#)

Specifications

- >> [Printing](#)
- >> [Printer Size](#)
- >> [Interface](#)
- >> [Environment](#)
- >> [Power Supply](#)
- >> [Media Specification](#)
- >> [Others](#)
- >> [Compatible Operating Systems](#)

Printing

Printing Technology	Direct Thermal
Print Resolution	203 dpi
Print Speed (depending on the media used) ¹	Maximum 127 mm/s Maximum 127 mm/s (When the Label Peeler is used.) Maximum 76.2 mm/s (When the Linerless Platen Kit is used.)
Maximum Print Width	<ul style="list-style-type: none"> • RJ-3235B/RJ-3255WB 72 mm • RJ-4235B/RJ-4255WB 104 mm
Maximum Print Length	<ul style="list-style-type: none"> - Continuous: 3,000 mm - Die-cut/Media with black marks: 1,000 mm
Minimum Print Length	<ul style="list-style-type: none"> • Continuous: 12.0 mm • Die-cut: 18.0 mm • Media with black marks: 12.7 mm

¹ RJ-3235B/RJ-3255WB: When using Brother's printing test data <76 mm x 29 mm, print coverage 10%> and printing continuously with a USB connection using a new fully charged lithium-ion battery in an environment of 23°C.
RJ-4235B/RJ-4255WB: When using Brother's printing test data <102 mm x 29 mm, print coverage 7%> and printing continuously with a USB connection using a new fully charged lithium-ion battery in an environment of 23°C.

Printer Size

Weight (including the rechargeable Li-ion battery)	<ul style="list-style-type: none"> • RJ-3235B/RJ-3255WB Approximately 810 g • RJ-4235B/RJ-4255WB Approximately 850 g
Dimensions	<ul style="list-style-type: none"> • RJ-3235B/RJ-3255WB Approximately 117 mm (W) x 77 mm (H) x 180 mm (D) • RJ-4235B/RJ-4255WB Approximately 153 mm (W) x 68 mm (H) x 159 mm (D)

Interface

USB	USB Ver.2.0 (Full Speed) (Type-C)
------------	-----------------------------------

Bluetooth	SPP, OPP, HCRP (Bluetooth Classic), GATT (Bluetooth Low Energy)
Ethernet	10 or 100 Mbps Ethernet (Enabled automatically when the printer is placed on the Charging Cradle)
Wireless LAN (5 GHz)	IEEE 802.11 a/n (Infrastructure Mode)
Wireless LAN (2.4 GHz)	IEEE 802.11 b/g/n (Infrastructure Mode) IEEE 802.11 g/n (Wireless Direct mode)
Protocol (IPv4)	ARP, RARP, BOOTP, DHCP, APIPA(Auto IP), WINS/NetBIOS Name Resolution, DNS Resolver, mDNS, LLMNR Responder, LPR/LPD, Custom Raw Port/Port9100, IPP/IPPS, FTP Client and Server, SNMPv1/v2c/v3, HTTP/HTTPS Client and Server, TFTP Server, ICMP, Web Services (Print), SNTP Client
Protocol (IPv6)	NDP, RA, DNS Resolver, mDNS, LLMNR Responder, LPR/LPD, Custom Raw Port/Port9100, IPP/IPPS, FTP Client and Server, SNMPv1/v2c/v3, HTTP/HTTPS Client and Server, TFTP Server, ICMPv6, Web Services (Print), SNTP Client
Network Security (Wired)	SSL/TLS1.0/1.1/1.2/1.3 (HTTPS, IPPS) SNMPv3, 802.1x (EAP-MD5, EAP-FAST, PEAP, EAP-TLS, EAP-TTLS)
Network Security (Wireless)	SSL/TLS1.0/1.1/1.2/1.3 (HTTPS, IPPS) SNMPv3, 802.1x (EAP-FAST, PEAP, EAP-TLS, EAP-TTLS)
Wireless Network Security	WEP 64/128 bit, WPA-PSK (TKIP/AES), WPA2-PSK (AES), WPA3-SAE (AES)
Wireless Certification	Wi-Fi Certification Mark License (WPA™/WPA2™/WPA3™ - Enterprise, Personal), Wi-Fi Protected Setup™ (WPS) Identifier Mark License

Environment

Operating Temperature	<ul style="list-style-type: none"> • RJ-3235B/RJ-3255WB <ul style="list-style-type: none"> - Operation: <ul style="list-style-type: none"> Rechargeable Li-ion Battery: -15°C to 50°C Recommended: 0°C to 40°C With Label Peeler: -10°C to 35°C With Linerless Platen Kit: 10°C to 30°C - Charging: <ul style="list-style-type: none"> 0°C to 40°C Recommended: 5°C to 35°C ¹ • RJ-4235B/RJ-4255WB <ul style="list-style-type: none"> - Operation: <ul style="list-style-type: none"> Rechargeable Li-ion Battery: -15°C to 50°C Recommended: 0°C to 40°C AC Adapter: -10°C to 40°C Car Adapter: -10°C to 50°C With Linerless Platen Kit: 10°C to 30°C - Charging: <ul style="list-style-type: none"> 0°C to 40°C Recommended: 5°C to 35°C ¹
Operating Humidity ²	<p>From 10% to 90%</p> <p>From 10% to 50% (When the Label Peeler/Linerless Platen Kit is used).</p>

¹ If the internal temperature of the battery is out of this range, charging may stop.

² No Condensation, Maximum wet bulb temperature: 27°C

Power Supply

Rechargeable Li-ion Battery	Rechargeable Li-ion battery: 7.2 V
AC Adapter (Optional)	AC Adapter (15 V)
Car Adapter (Optional)	Car Adapter or Wired type (12 V (DC))
Maximum number of printed labels ^{1 2}	<ul style="list-style-type: none"> • RJ-3235B/RJ-3255WB 15,000 • RJ-4235B/RJ-4255WB 10,000
Charging time ³	<ul style="list-style-type: none"> • About 3 hours (with AC adapter) • About 3 hours (with USB Type-C (C-C) cable) • About 9 hours (with USB Type-C (C-A) cable)

¹ RJ-3235B/RJ-3255WB: Using Brother's printing test data <76 mm x 29 mm, printing rate 10%> at 23°C.
RJ-4235B/RJ-4255WB: Using Brother's printing test data <102 mm x 29 mm, print coverage 7%> at 23°C.

² When using a fully charged new rechargeable battery and continuously printing via USB connection. However, the above information cannot be guaranteed as it changes depending on printing conditions, usage environment, battery deterioration, etc.

³ When the printer is turned off, a new Rechargeable Li-ion Battery is used, and charged at 23°C.
Charging time from when `Recharge Battery!` appears on the LCD to full charge.

Media Specification

The media material may affect the print quality.

In order to achieve optimum print results, we recommend using genuine Brother media.

Media Type	Receipt, Gap/Black mark Label, Tag, Linerless (Optional)
Media Width	<ul style="list-style-type: none"> • RJ-3235B/RJ-3255WB From 25.4 mm to 80 mm • RJ-4235B/RJ-4255WB From 45 mm to 114 mm
Thickness	Receipt: From 0.058 mm to 0.090 mm Tag: From 0.090 mm to 0.135 mm Label: From 0.080 mm to 0.170 mm
Roll Outside Diameter (maximum)	<ul style="list-style-type: none"> • RJ-3235B/RJ-3255WB 66 mm • RJ-4235B/RJ-4255WB 58 mm
Media Roll Holder Core Diameter	Standard (Grey): 25.4 mm (Default) In-box (Black): 12.7 mm - 13.0 mm /19.0 mm
Media Sensor	Transmissive, Reflective

Others

Drop Protection ¹	<ul style="list-style-type: none"> • RJ-3235B/RJ-3255WB 2.0 m • RJ-4235B/RJ-4255WB 2.1 m
Sealing	IP54 rated
Vibration/Shock	MIL-STD-810G

¹ Multiple drops to concrete, under controlled environment.

Compatible Operating Systems

For the latest list of compatible software, visit support.brother.com/os.



Related Information

- [Appendix](#)

Related Topics:

- [Load the Roll](#)
-

Software Development Kit

Software Development Kit (SDK) is available from the Brother Developer Center (<https://support.brother.com/g/s/es/dev/en/index.html>).

The b-PAC SDK and the SDKs for mobile devices (Android™, iPhone, and iPad) can also be downloaded. (The SDKs available are subject to change without notice.)



Related Information

- [Appendix](#)

LabelCLT

- [LabelCLT Overview](#)
- [Transfer the Template Data File with LabelCLT](#)
- [Transferring a PDZ Firmware File via USB: Example](#)

LabelCLT Overview

Overview

LabelCLT is a command line tool that allows you to transfer files and obtain status from the printer using the command line.

To download LabelCLT, go to your model's **Downloads** page on the Brother support website at support.brother.com.

Operating Environment

Supported Operating Systems

Windows only. For the latest list of supported Windows Operating Systems, visit support.brother.com.

Communication Interface

USB, Wired LAN, or Wireless LAN

File Types

File Type	Generated From	Supported Interfaces
BIN	Device Settings, Communication Settings, P-touch Template Settings, and Paper Size Setup	USB, LAN
PDZ	Firmware and P-touch Editor	USB
BLF	Device Settings, Communication Settings, P-touch Template Settings, Paper Size Setup, P-touch Editor, and LabelCLT	USB, LAN
CSV	Windows applications	USB, LAN
OTF	Font file types	USB
TTF		
PEM	File format used for security certificates.	USB



Related Information

- [LabelCLT](#)

Transfer the Template Data File with LabelCLT

For supported commands, usage examples, and errors not listed here, see the LabelCLT manual on the Brother support website at support.brother.com.

>> [Install LabelCLT](#)

>> [Basic File Transfer Procedure](#)

Install LabelCLT

1. Download LabelCLT to your computer.
2. Type "cmd" in the Windows search box to start the command prompt.
3. Type the drive where LabelCLT is saved and press Enter. (In this example, LabelCLT is saved on the "C" drive.)

```
J:\>c:
```

4. Type **cd**, add a space, and then copy and paste the path of the folder where the "LabelCLT.exe" file is located (in this example: **cd c:\LabelCLT**). Press Enter.

```
c:\>cd c:\LabelCLT
```

5. Type **LabelCLT.exe /eula** and press Enter to display the License Agreement. If you agree to the terms of the License Agreement, type "y" (for "yes") on your keyboard and press Enter.

Basic File Transfer Procedure

1. Access the printer using one of the commands below depending on your interface.

Command	Function	Example
/ip:"IP Address"	LAN: Specify IP or NodeName.	/ip:"192.168.0.250" or /ip:"BRW00AABBFF"
/printer:"Printer Name"	USB: Specify the printer name.	/printer:"Brother RJ-4235B"

2. Transfer files using commands below.

Command	Function	Example
/send_pdz:"FilePath"	Send the specified PDZ file	/printer:"Brother RJ-4235B/send_pdz:"c:\test\a.pdz"
/send_blf:"FilePath"	Send the specified BLF file	/ip:"192.168.0.250" /send_blf:"c:\test\a.blf"
/send_bin:"FilePath"	Send the specified BIN file	/ip:"192.168.0.250" /send_bin:"c:\a.bin"
/send_csv:"FilePath"	Send the specified CSV file	/ip:"192.168.0.250" /send_csv:"c:\test\a.csv"

✓ Related Information

- [LabelCLT](#)

Transferring a PDZ Firmware File via USB: Example

1. Specify the printer with the **LabelCLT.exe /printer** command, and specify the file to be transferred with the **/send_pdz** command, and then press Enter.

```
c:\LabelCLT>LabelCLT.exe /printer:"Brother RJ-4235B" /send_pdz:"c:\test\1a.pdz"
```

2. The transfer will start, and the transfer progress will be displayed.
3. When the transfer is complete, LabelCLT will wait until the printer finishes writing the firmware.
4. When the printer has finished writing the firmware, it will restart and LabelCLT will reconnect.
5. After reconnection, compare the transferred firmware version with the current printer firmware version.
6. If the update has been successfully completed, **Succeeded** is displayed.

Integration with the **Windows Task Scheduler** allows to implement instructions at specified times or on a regular basis.

1. Prepare a batch file with the command you want to implement - for example, check the firmware version.

```
cd/d %~dp0  
LabelCLT.exe /printer:"Brother RJ-4235B" /get_firmwarever  
pause
```

2. Start the **Windows Task Scheduler**.

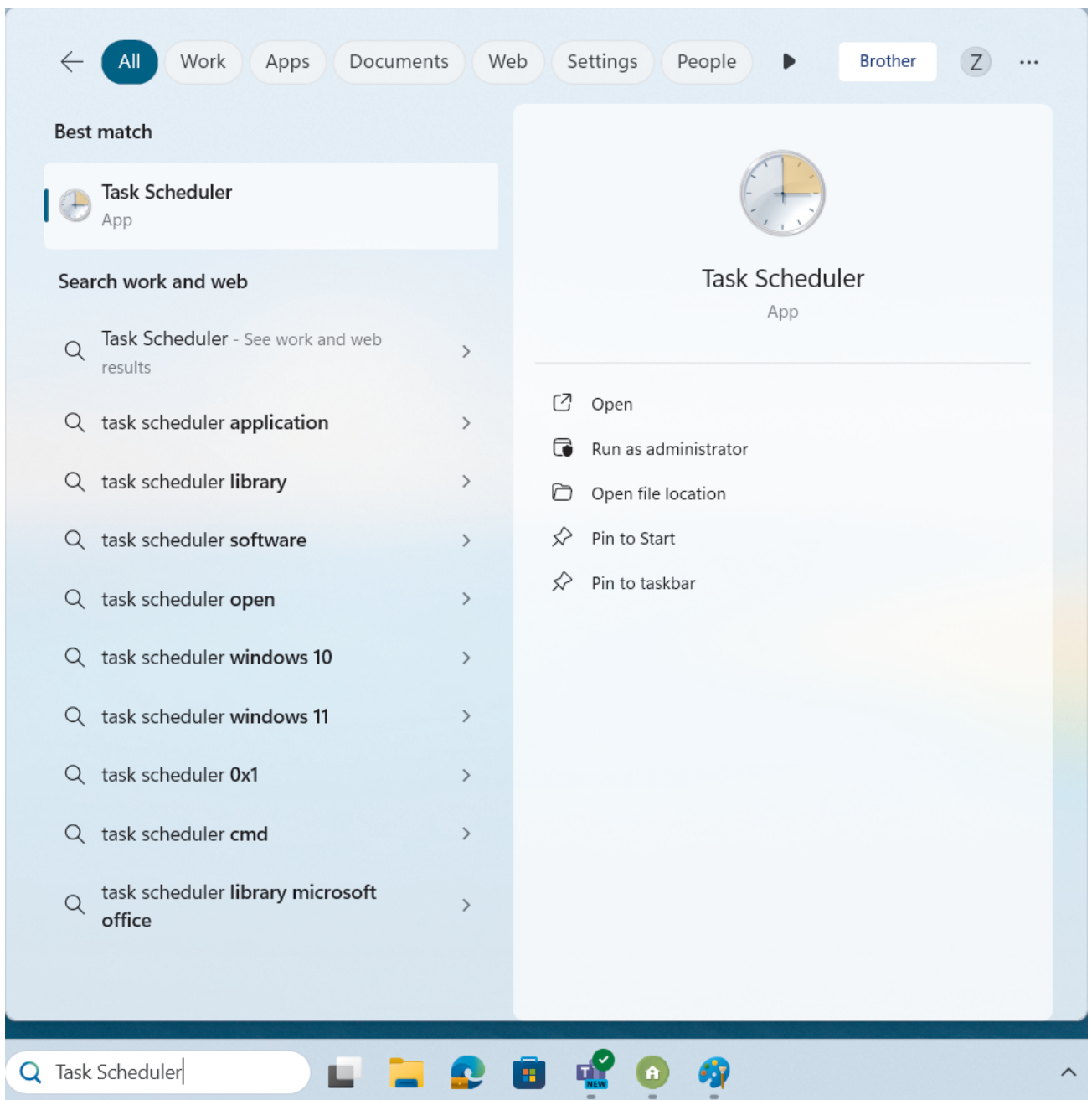

3. Click **Create Basic Task**.

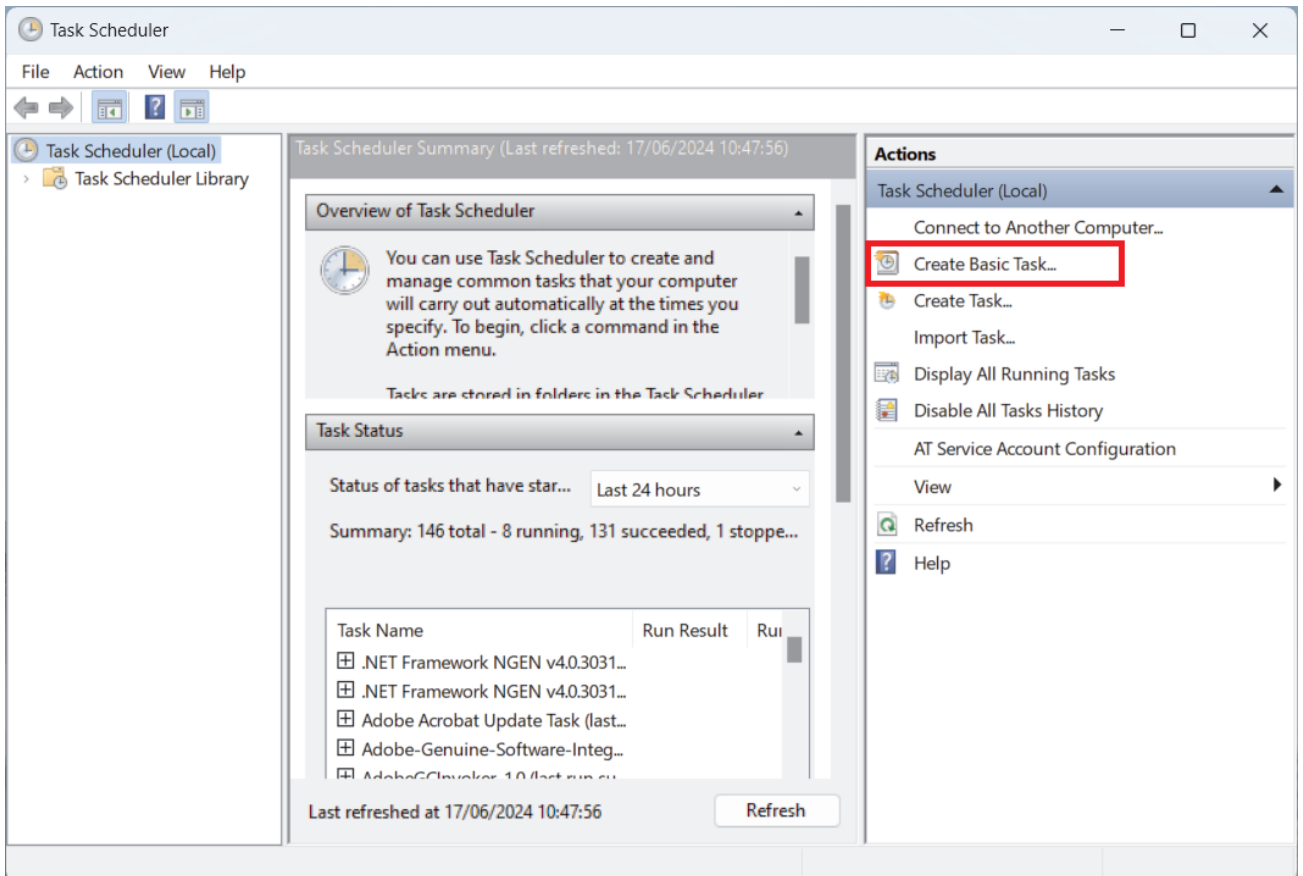

4. Type the task name in the **Name** field, and then click **Next**.

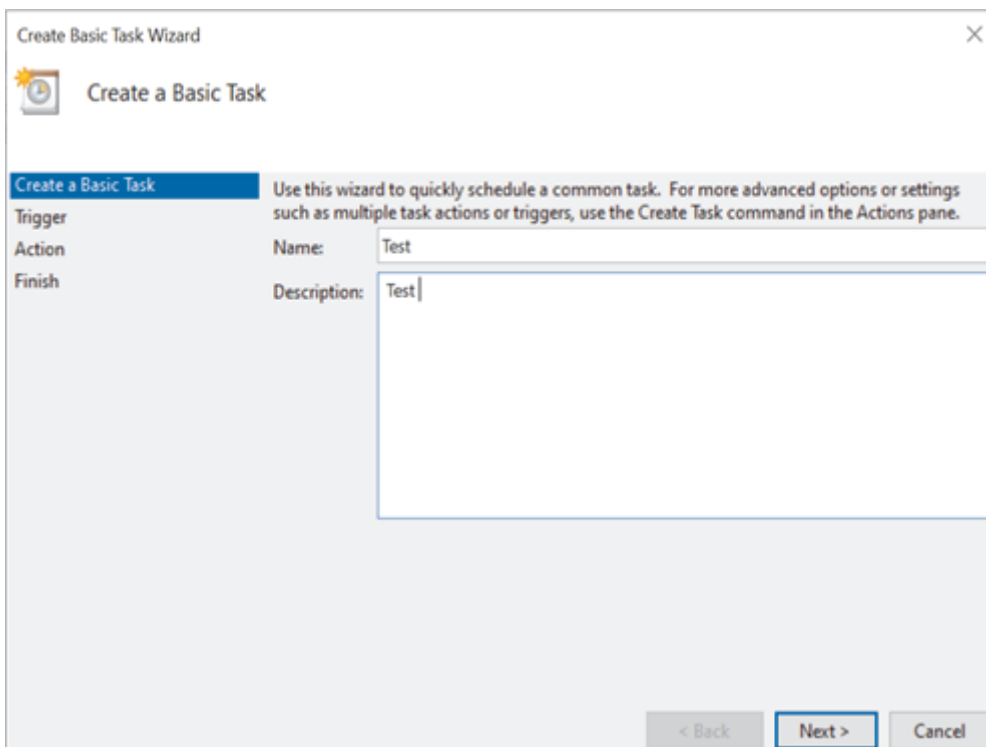

5. Select the trigger for the task.

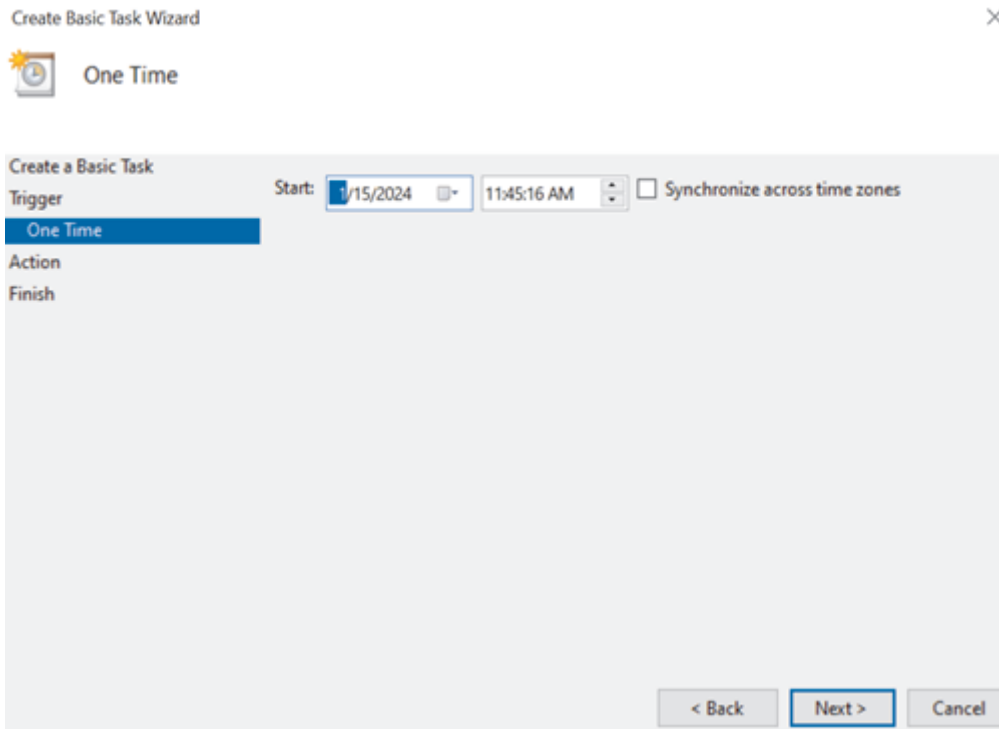
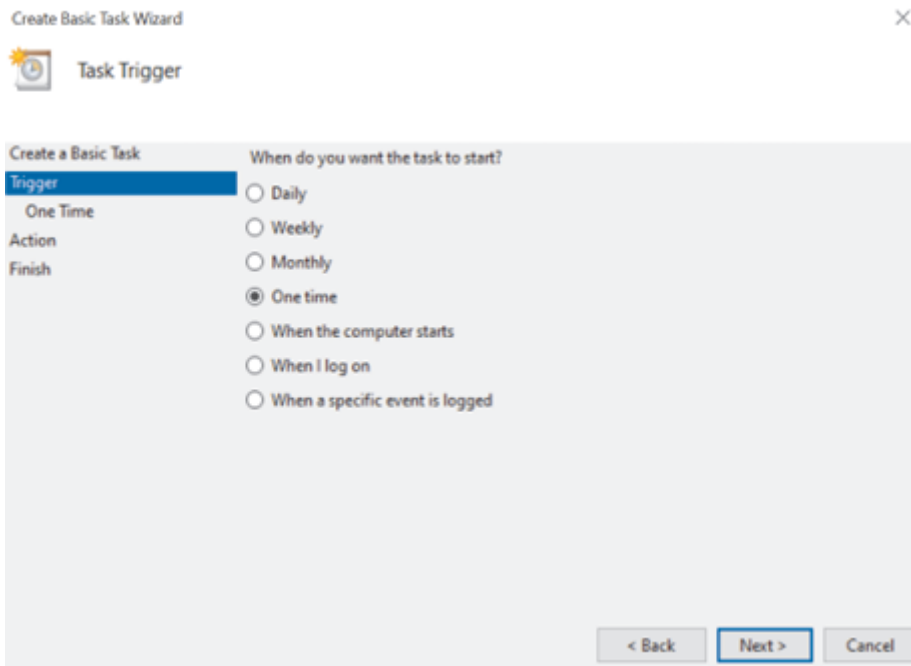

6. Select what you want to perform in the task (in this example, we have selected to **Start a program**), and then click **Next**.

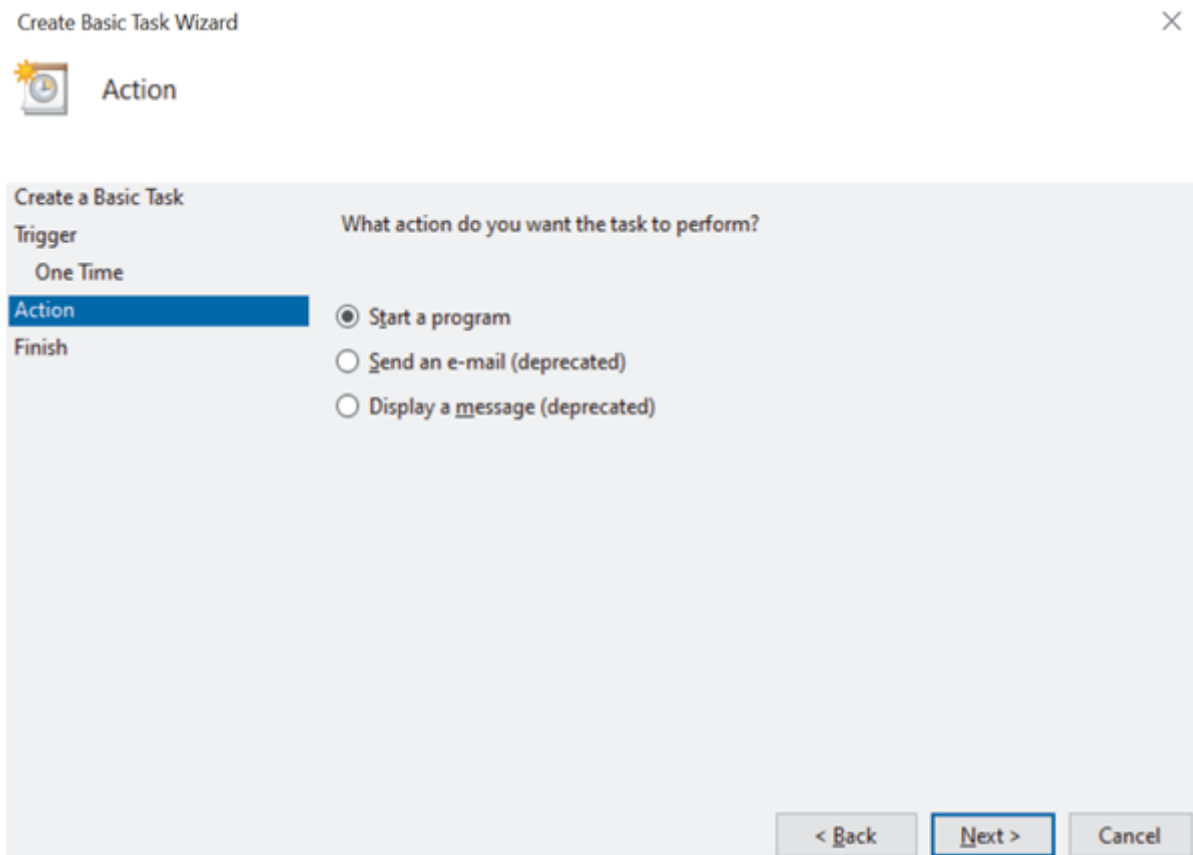

7. Specify the prepared batch file in the **Program/script** field, and then click **Next**.

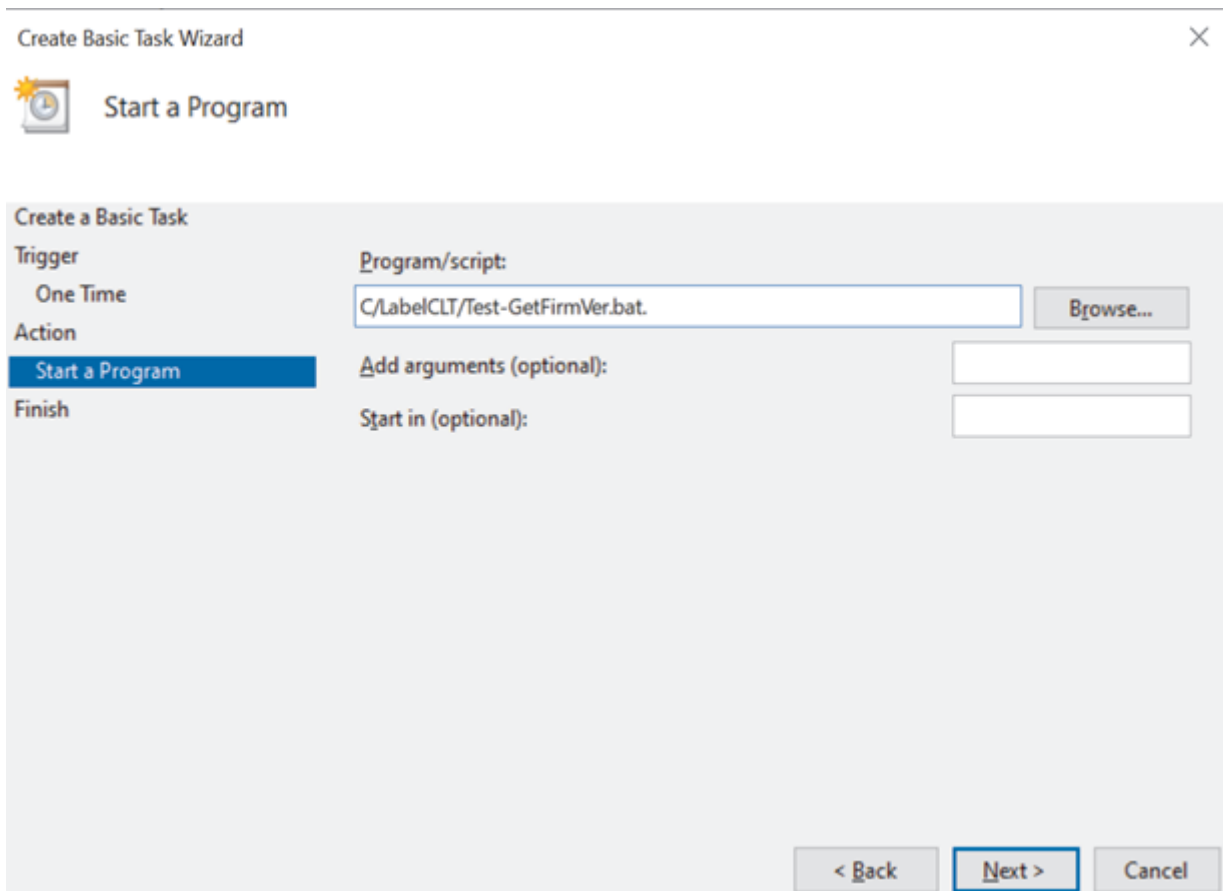

- Click **Finish** to complete creating the task.

Create Basic Task Wizard

Summary

Create a Basic Task

Trigger

One Time

Action

Start a Program

Finish

Name: Test

Description: Test

Trigger: One time; At 11:45 AM on 1/15/2024

Action: Start a program; C:/LabelCLT/Test-GetFirmVer.bat.

Open the Properties dialog for this task when I click Finish

When you click Finish, the new task will be created and added to your Windows schedule.

< Back Finish Cancel

- The task of checking the target printer's firmware will be completed at the specified time and using the specified batch file.

✓ Related Information

- [LabelCLT](#)

Optional Accessories

- [Battery Charger \(Optional: PA-BC-003\)](#)
- [Label Peeler \(Optional: PA-LP-007\)](#)
- [Linerless Platen Kit \(Optional: PA-LPR-004/PA-LPR-001\)](#)
- [Charging Cradle \(Optional: PA-CR-005\)](#)
- [4-bay Charging Cradle \(Optional:PA-4CR-003\)](#)
- [Charging Cradle \(Optional: PA-CR-002A\)](#)

Battery Charger (Optional: PA-BC-003)

- [Battery Charger Overview](#)
- [Charge the Rechargeable Li-ion Battery Using the Battery Charger](#)
- [Mount the Battery Charger on the Wall](#)
- [Connect Multiple Battery Chargers Together](#)

Battery Charger Overview

Parts Description

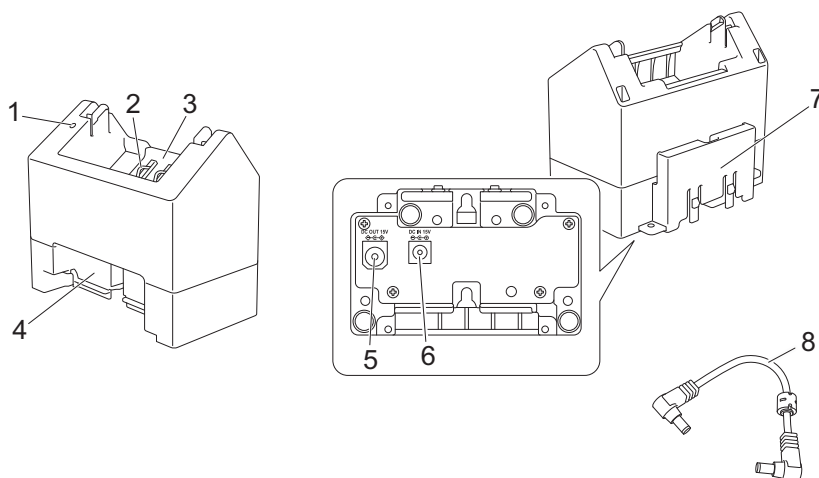

1. Charge Indicator
2. Battery Charging Terminals
3. Rechargeable Li-ion Battery Compartment
4. Locking Expansion Slot
5. DC Connector OUT
6. DC Connector IN
7. Locking Expansion Hook
8. DC Cord

Specifications

Charge time	Approximately 4 hours ¹
Charge temperature	0°C to 40°C (Recommended: 5°C to 35°C)
Operating humidity	10% to 90% (No condensation)

¹ Varies depending on the operating environment and the condition of the rechargeable Li-ion battery.

✓ Related Information

- [Battery Charger \(Optional: PA-BC-003\)](#)

Charge the Rechargeable Li-ion Battery Using the Battery Charger

To charge the rechargeable Li-ion battery, use the Battery Charger (PA-BC-003) together with the AC Adapter (PA-AD-600A, sold separately).

The Battery Charger cannot charge the rechargeable Li-ion battery alone.

1. Connect the AC Adapter to the Battery Charger's DC Connector IN.
2. Connect the AC power cord to the AC Adapter.

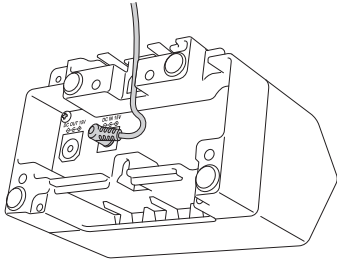

Insert the AC Adapter cord through the opening in the Battery Charger as shown in the illustration. Make sure you do not pinch the cord.

3. Connect the AC power cord to a nearby electrical socket.
4. Align the Battery Charging Terminals of the charger and the rechargeable Li-ion battery, and then insert the rechargeable Li-ion battery.

The Charge Indicator lights in orange when the rechargeable Li-ion battery is charging.

5. The Charge Indicator will turn off when charging is complete. Remove the rechargeable Li-ion battery.

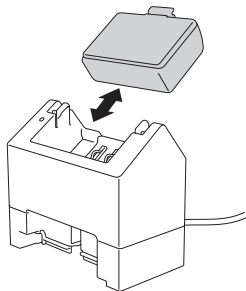

Related Information

- [Battery Charger \(Optional: PA-BC-003\)](#)

Mount the Battery Charger on the Wall

Use two screws to mount the Battery Charger to a wall.

Install the screws vertically with the spacing shown below.

Ensure the screws are correctly secured with wall anchors or studs. The rechargeable Li-ion battery compartment must face upwards (as shown) to hold the rechargeable Li-ion battery in place.

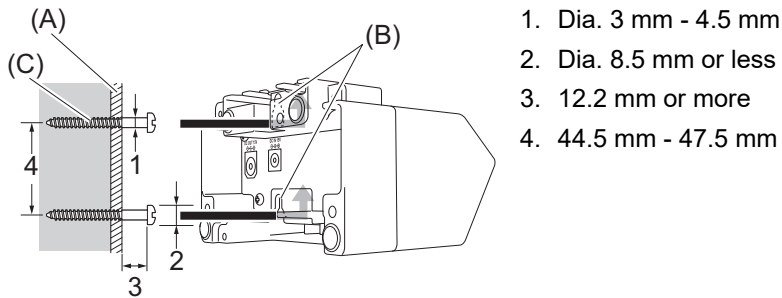

- (A) Wall material
(B) Wall-mount slots
(C) Screw

Use the insert nuts on the base of the Battery Charger to fasten the screws to the wall.

Use the following types of screws.

- M2.6 Pitch 0.45 screws
- Screws that are between 3.5 mm and 7 mm longer than the thickness of the board (when attaching to a vertical board).



- When attaching to a vertical board, the method of installation is the same as wall mounting.
- Be sure not to pinch the cables between the base of the Battery Charger and the board.

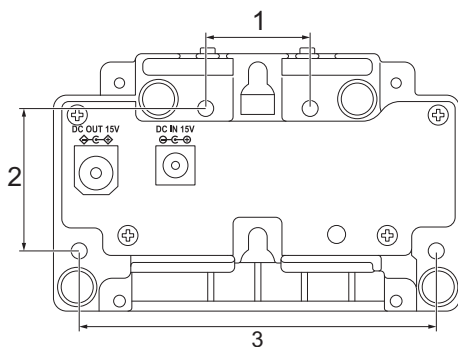

1. 27.7 mm
2. 38 mm
3. 95 mm



Related Information

- [Battery Charger \(Optional: PA-BC-003\)](#)

Connect Multiple Battery Chargers Together

Up to four battery chargers can be connected in-line together.

>> [Connect the Battery Chargers](#)

>> [Disconnect the Battery Chargers](#)

Connect the Battery Chargers

1. Insert the Locking Expansion Hook of the first Battery Charger into the Locking Expansion Slot of the second Battery Charger until it locks into place.

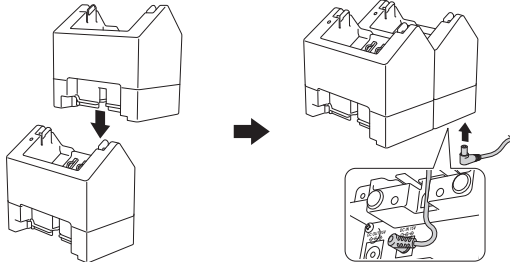

2. Connect the AC Adapter to the first Battery Charger.
3. Connect one end of the included DC cord to the DC Connector OUT of the first Battery Charger.
4. Connect the other end of the DC cord to the DC Connector IN of the second Battery Charger.

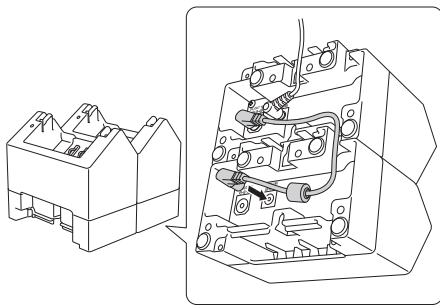

- Connect the AC Adapter and DC cord through the opening in the Battery Charger as shown in the illustration.

Make sure you do not pinch the cords when connecting the Battery Chargers.

- When connecting the Battery Chargers, we recommend using self-tapping screws (M2.6 x 6 mm) (not included) to firmly secure the Battery Chargers to one another.

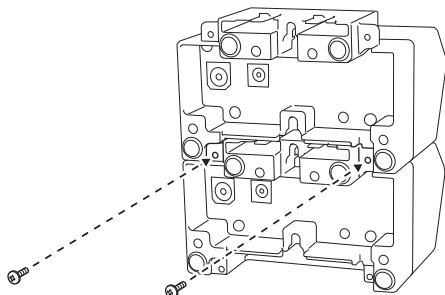

Disconnect the Battery Chargers

1. Disconnect the DC cord and the AC Adapter from the Battery Chargers.
2. Push the tab on the Locking Expansion Hook to release the lock.

3. Disconnect the Battery Chargers.

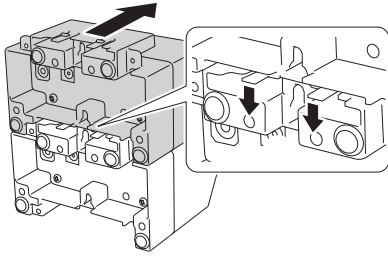

 **Related Information**

- [Battery Charger \(Optional: PA-BC-003\)](#)

Label Peeler (Optional: PA-LP-007)

Related Models: RJ-3235B/RJ-3255WB

- [Install the Label Peeler](#)
- [Change the Label Peeler Options \(Windows\)](#)

Install the Label Peeler

Related Models: RJ-3235B/RJ-3255WB

This printer is compatible with the Label Peeler (PA-LP-007).

Parts Description

Label Peeler Assembly Screws (2 each)

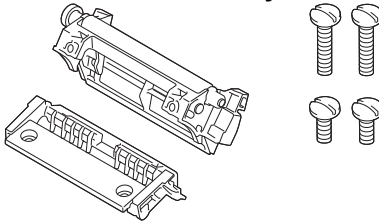

1. Push the Roll Cover Release Lever to open the Roll Compartment Cover.

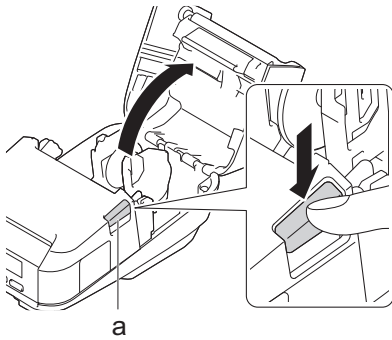

a. Roll Cover Release Lever

2. Remove the standard platen and holder unit by removing the four screws shown in the illustration.

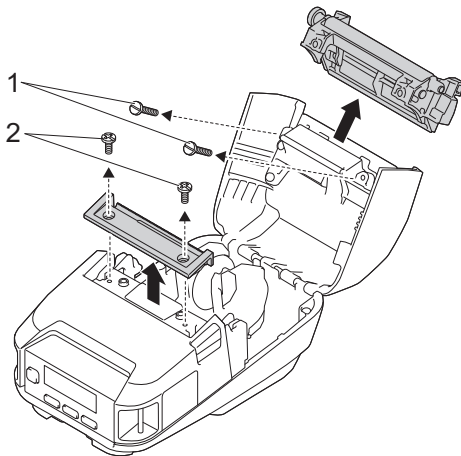

⚠ CAUTION

- Do not touch the blade when removing the standard platen.
- Do not touch the tear bar when removing the holder unit.



Recommended tightening torque:

(1) 0.4 ± 0.049 N·m

(2) 0.5 ± 0.049 N·m

3. Install the platen and holder unit, and fasten them using the four screws supplied with the Label Peeler.

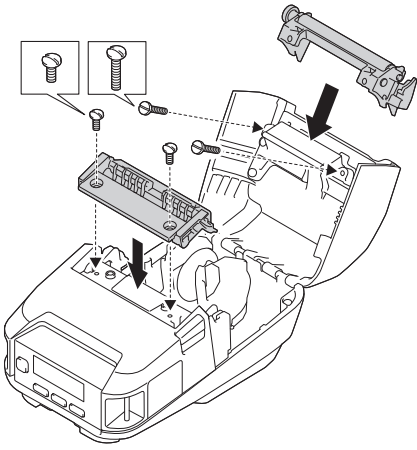

The upper tear bar and lower tear bar cannot be used when the Label Peeler is installed.

4. Peel off a few labels. Then, set the Roll so that the next label does not cover the Media Sensor area.

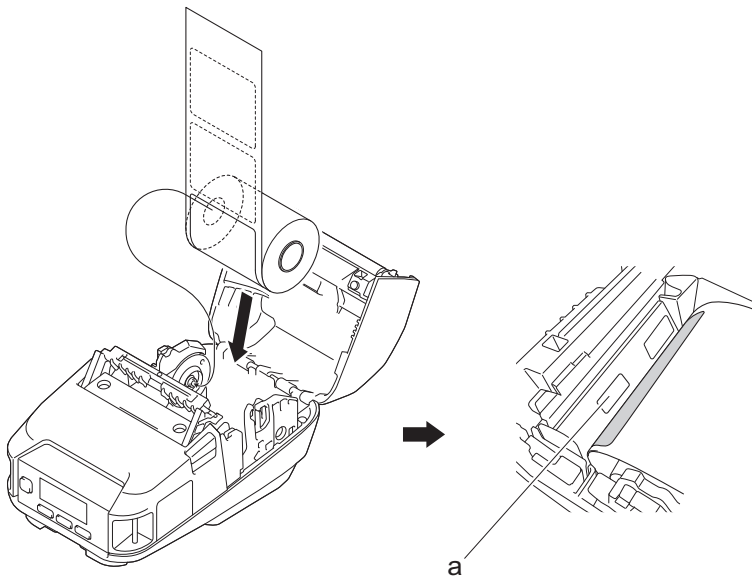

a. Media sensor

5. Close the Roll Compartment Cover.
6. Lightly pull on the paper in the Paper Exit Slot to remove any slack in the roll.

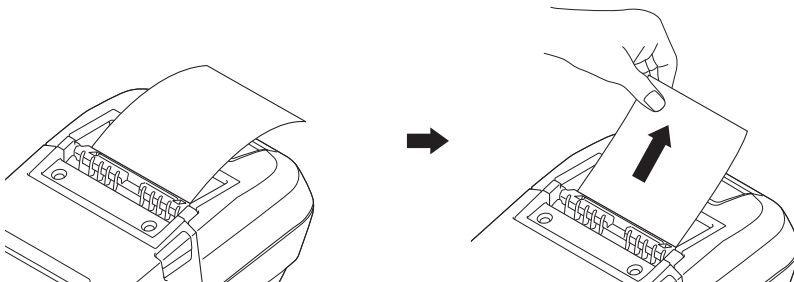

IMPORTANT

- Before using the Label Peeler, specify the following settings:
 - Set **Exit Position** to **Peeler** in the **Basic** tab of the BRConfiguration Tool.
 - Select the **Use Peeler Function** checkbox on the **Basic** tab of the printer driver properties. For more information, see *Related Topics*.
- When not using the Label Peeler, specify the following settings:
 - Set **Exit Position** to **Tear** in the **Basic** tab of the BRConfiguration Tool.

-
- Clear the **Use Peeler Function** checkbox on the **Basic** tab of the printer driver properties.
7. Set **Exit Position** to **Peeler** in the **Basic** tab of the BRConfiguration Tool.

NOTE

- When **Peeler** is set to **Exit Position**, [Tear Bar] in [Settings] and [Auto Detect] in [Media] cannot be selected on the printer's LCD.
- For best performance, make sure the paper's head margin is at least 3 mm.
- When using the Label Peeler, paper dust may stick to the print head. Clean the print head regularly. For more information, see *Related Topics*:
- Use the latest firmware when printing with the Label Peeler.



Related Information

- [Label Peeler \(Optional: PA-LP-007\)](#)

Related Topics:

- [Maintenance](#)
-

Change the Label Peeler Options (Windows)

After attaching the Label Peeler, set the printer driver peeler option:

1. Select the **Use Peeler Function** checkbox in the printer driver.
2. Click **OK**.



Related Information

- [Label Peeler \(Optional: PA-LP-007\)](#)
-

Linerless Platen Kit (Optional: PA-LPR-004/PA-LPR-001)

RJ-3235B/RJ-3255WB	PA-LPR-004
RJ-4235B/RJ-4255WB	PA-LPR-001

- [Install the Linerless Platen Kit](#)

Install the Linerless Platen Kit

This printer is compatible with linerless media.

Parts Description

Linerless Platen Screws (2)

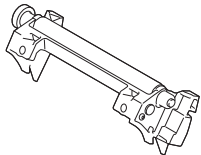

1. Push the Roll Cover Release Lever to open the Roll Compartment Cover.

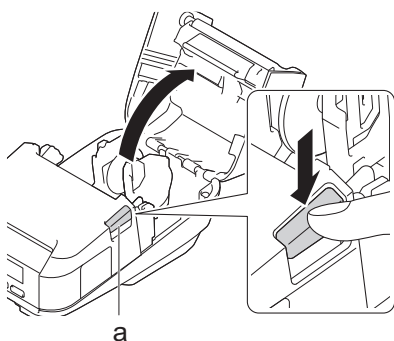

a. Roll Cover Release Lever

2. Remove the standard platen by removing the two screws shown in the illustration.

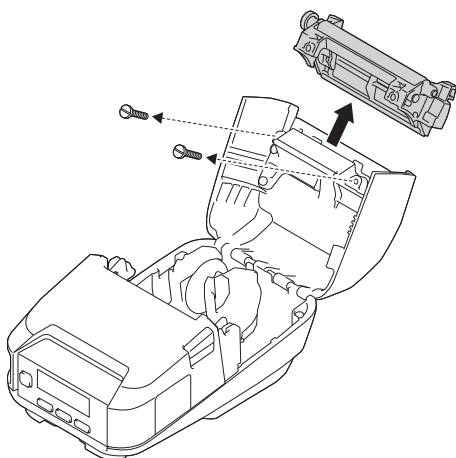

CAUTION

Do not touch the blade when removing the standard platen.



Recommended tightening torque: 0.4 ± 0.049 N·m.

-
3. Install the Linerless Platen, and fasten it using the two screws included in the Linerless Platen Kit.

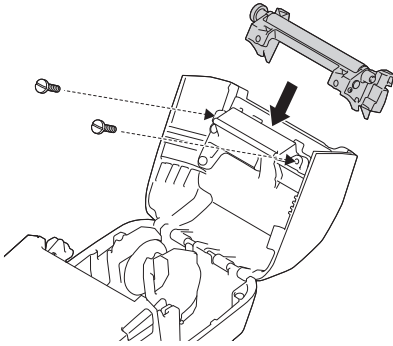

The lower tear bar cannot be used when the Linerless Platen is installed.

4. Set **Linerless** to **On** in the **Advanced** tab of the BRConfiguration Tool.

NOTE

- When **Linerless** is set to **On**, [Tear Bar] in [Settings] and [Auto Detect] in [Media] cannot be selected on the printer's LCD.
- For best performance, make sure the paper's head margin is as follows:
 - RJ-3235B/RJ-3255WB: At least 12 mm
 - RJ-4235B/RJ-4255WB: At least 9 mm
- When using the Linerless Platen, paper dust may stick to the print head. Clean the print head regularly. For more information, see *Related Topics*:
- Use the latest firmware when printing with the Linerless Platen.



Related Information

- [Linerless Platen Kit \(Optional: PA-LPR-004/PA-LPR-001\)](#)

Related Topics:

- [Maintenance](#)
 - [Linerless Platen Kit \(Optional\) Problems](#)
-

Charging Cradle (Optional: PA-CR-005)

Related Models: RJ-3235B/RJ-3255WB

- [Charging Cradle Overview \(Optional: PA-CR-005\)](#)
- [Charge the Rechargeable Li-ion Battery Using the Charging Cradle \(Optional: PA-CR-005\)](#)
- [Connect the Printer to a Wired LAN Network via Charging Cradle \(Optional: PA-CR-005\)](#)
- [Mount the Charging Cradle on the Wall \(Optional: PA-CR-005\)](#)

Charging Cradle Overview (Optional: PA-CR-005)

Related Models: RJ-3235B/RJ-3255WB

Parts Description

Charging Cradle

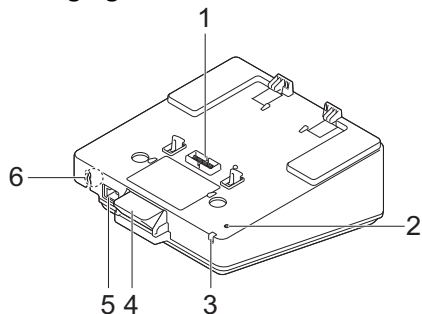

1. Charging Cradle Terminals
2. Ethernet (LAN) LED
3. Charging LED
4. Eject Button
5. Ethernet (LAN) Port
6. DC Connector

Charging Cradle Terminal Attachment

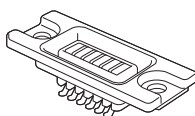

Screws (2)

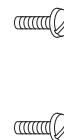

Specifications

Charging time	About 3 hours ¹
Charging temperature	From 5°C to 35°C
Operating temperature	From 0°C to 40°C
Operating humidity	From 10% to 90% (without condensation)

¹ Varies depending on the operating environment and the condition of the rechargeable Li-ion battery.

NOTE

When the printer is placed on the Charging Cradle, we recommend using the **After one page of data is received** setting in the **Other** tab of the printer driver properties before printing.

✓ Related Information

- [Charging Cradle \(Optional: PA-CR-005\)](#)

Related Topics:

- [Charging Cradle \(Optional\) Problems](#)

Charge the Rechargeable Li-ion Battery Using the Charging Cradle (Optional: PA-CR-005)

Related Models: RJ-3235B/RJ-3255WB

The Charging Cradle (PA-CR-005) cannot recharge the printer's rechargeable Li-ion battery without being connected to an electrical socket using the AC Adapter (PA-AD-600A).

- >> [Before Charging the Rechargeable Li-ion Battery](#)
- >> [Charge the Rechargeable Li-ion Battery](#)
- >> [Remove the Printer from the Charging Cradle](#)
- >> [Lock the Eject Button](#)

Before Charging the Rechargeable Li-ion Battery

1. Remove the Charging Cradle terminal cover with a flathead screwdriver.

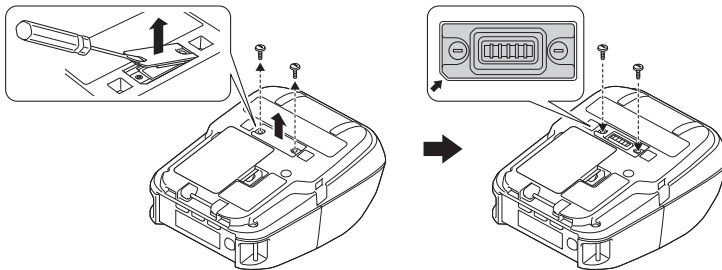

2. Install the Charging Cradle Terminal Attachment onto the printer using the Charging Cradle Terminal Attachment and screws included with the Charging Cradle.



Make sure the notched corner is aligned correctly.

Charge the Rechargeable Li-ion Battery

1. Connect the AC Adapter to the Charging Cradle's DC Connector.

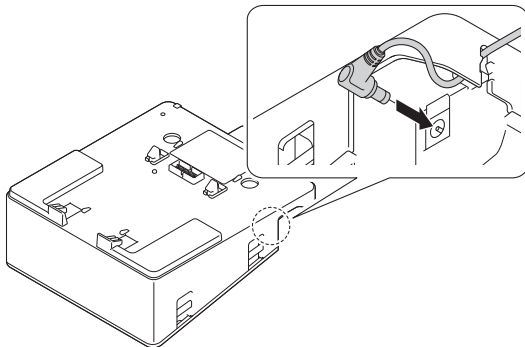

2. Connect the AC power cord to the AC Adapter.
3. Connect the AC power cord to a nearby electrical socket.

4. Align the Charging Cradle Terminals of the Charging Cradle and the printer.

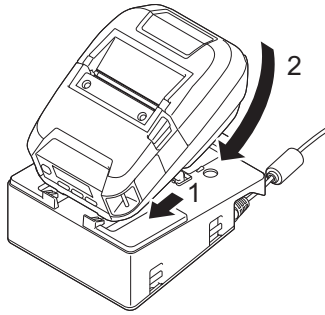

5. Press the printer down and onto the Charging Cradle until the latches lock it firmly in place.
The printer's LED Indicator lights in orange when charging.

The printer's LED Indicator will turn off when charging is complete.

Remove the Printer from the Charging Cradle

Push the Eject Button on the back of the Charging Cradle, lift the printer, and then remove it from the Charging Cradle.

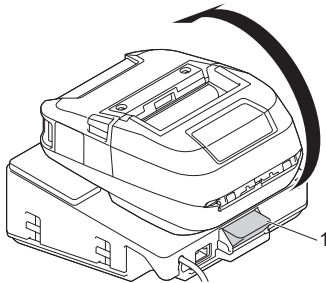

1. Eject Button

Lock the Eject Button

Insert a cotter pin (or similar) through the hole as illustrated below.



Use a Low Carbon Steel Extended Prong Retaining Cotter Pin (not included): Length: 50 mm, Pin Diameter: 2 mm

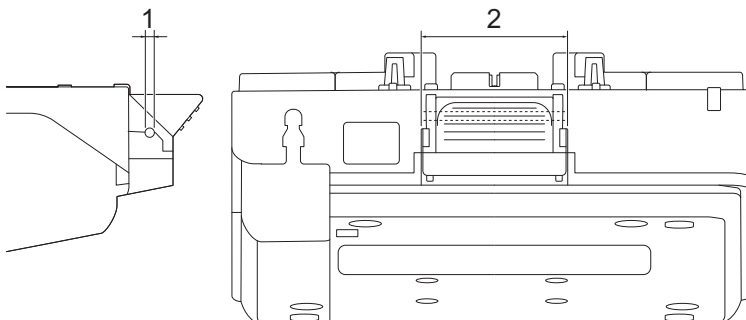
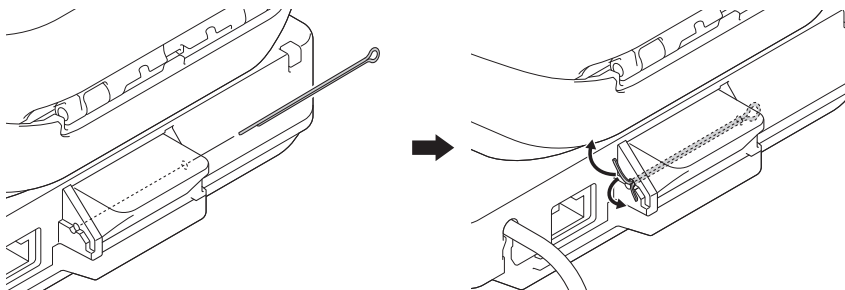

1. Diameter: 2.3 mm

2. Length: 41.2 mm



To purchase the Cotter Pin, contact your local Brother dealer.



Related Information

- [Charging Cradle \(Optional: PA-CR-005\)](#)
-

Connect the Printer to a Wired LAN Network via Charging Cradle (Optional: PA-CR-005)

Related Models: RJ-3235B/RJ-3255WB

Use an Ethernet (LAN) connection to configure your printer and upgrade its firmware.

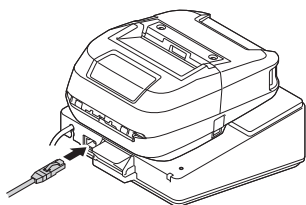

LED Indicators

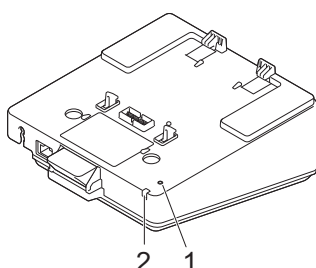

1. Ethernet (LAN) LED

LED Indicator	Status
	Ethernet (LAN) not connected
	<ul style="list-style-type: none"> Ethernet (LAN) connected Receiving or sending data via Ethernet (LAN)



The Ethernet (LAN) LED does not light up unless the printer is placed on the Charging Cradle.

2. Status LED

LED Indicator	Status
	The printer is placed on the Charging Cradle and the rechargeable Li-ion battery is fully charged.
	The printer is charging via Charging Cradle

Interface compatibility

Use the [WLAN] and [Wired LAN] menus to select WLAN, Wired LAN, or no connection when the printer is on the Charging Cradle.

Cradle LAN Setting	WLAN Setting	Connection type when using the Charging Cradle
On	On	WLAN →Wired LAN ¹
On	Off	Wired LAN
Off	On	WLAN
Off	Off	No connection enabled

¹ Wireless Direct function is not affected.



Related Information

- [Charging Cradle \(Optional: PA-CR-005\)](#)

Mount the Charging Cradle on the Wall (Optional: PA-CR-005)

Related Models: RJ-3235B/RJ-3255WB

1. Drill four holes in a commercially available board according to the spacing of the screw holes of the Charging Cradle.

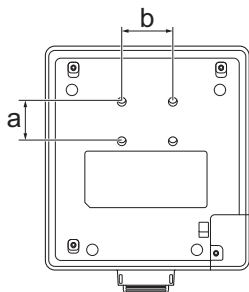

- a. Height: 30 mm
- b. Width: 38.1 mm

2. Affix the Charging Cradle to the board using four screws, as shown in the illustration.

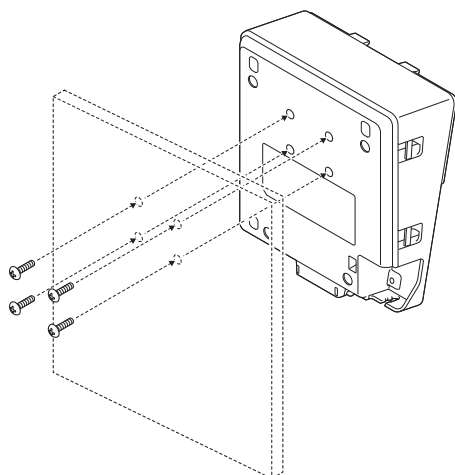

- Make sure you install the Charging Cradle in the correct direction so that the printer will not fall.
- Use M5 size screws.

3. Lean the board against the wall or secure the board to the wall.

✓ Related Information

- [Charging Cradle \(Optional: PA-CR-005\)](#)

4-bay Charging Cradle (Optional:PA-4CR-003)

Related Models: RJ-3235B/RJ-3255WB

- [4-bay Charging Cradle Overview](#)
- [Charge the Rechargeable Li-ion Battery Using the 4-bay Charging Cradle](#)
- [Connect the Printer to a Wired LAN Network via 4-bay Charging Cradle](#)
- [Mount the 4-bay Charging Cradle on the Wall](#)

4-bay Charging Cradle Overview

Related Models: RJ-3235B/RJ-3255WB

Parts Description

4-bay Charging Cradle

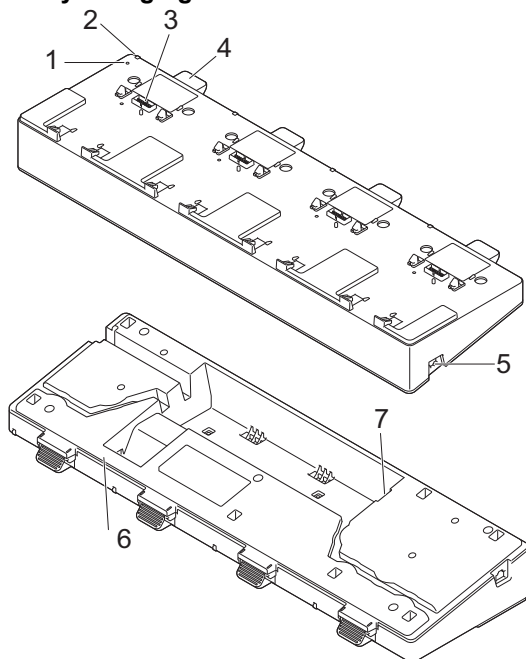

1. Ethernet (LAN) LED
2. Charging LED
3. Charging Cradle Terminals
4. Eject Button
5. Ethernet (LAN) Port 1
For connecting to a wired network.
6. DC Connector
7. Ethernet (LAN) Port 2
For connecting multiple 4-bay Charging Cradles to each other.

Charging Cradle Terminal Attachment

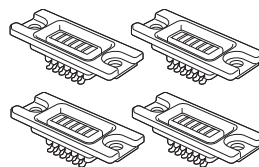

Screws (8)



Specifications

Charging time	About 3 hours ¹
Charging temperature	From 5°C to 35°C
Operating temperature	From 0°C to 40°C
Operating humidity	From 10% to 90% (without condensation)

¹ Varies depending on the operating environment and the condition of the rechargeable Li-ion battery.

NOTE

When the printer is placed on the Charging Cradle, we recommend using the **After one page of data is received** setting in the **Other** tab of the printer driver properties before printing.



Related Information

- [4-bay Charging Cradle \(Optional:PA-4CR-003\)](#)

Related Topics:

- [Charging Cradle \(Optional\) Problems](#)

Charge the Rechargeable Li-ion Battery Using the 4-bay Charging Cradle

Related Models: RJ-3235B/RJ-3255WB

The 4-bay Charging Cradle cannot recharge the printer's rechargeable Li-ion battery without being connected to an electrical socket using the AC adapter (PA-AD-600A).

- >> [Before Charging the Rechargeable Li-ion Battery](#)
- >> [Charge the Rechargeable Li-ion Battery](#)
- >> [Remove the Printer from the Charging Cradle](#)

Before Charging the Rechargeable Li-ion Battery

1. Remove the Charging Cradle terminal cover with a flathead screwdriver.

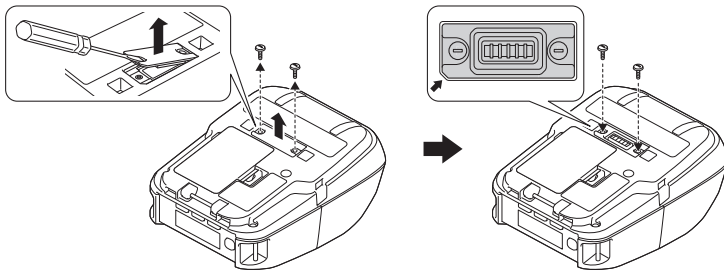

2. Install the Charging Cradle Terminal Attachment onto the printer using the Charging Cradle Terminal Attachment and screws included with the Charging Cradle.

 Make sure the notched corner is aligned correctly.

Charge the Rechargeable Li-ion Battery

1. Connect the AC Adapter to the Charging Cradle's DC Connector.

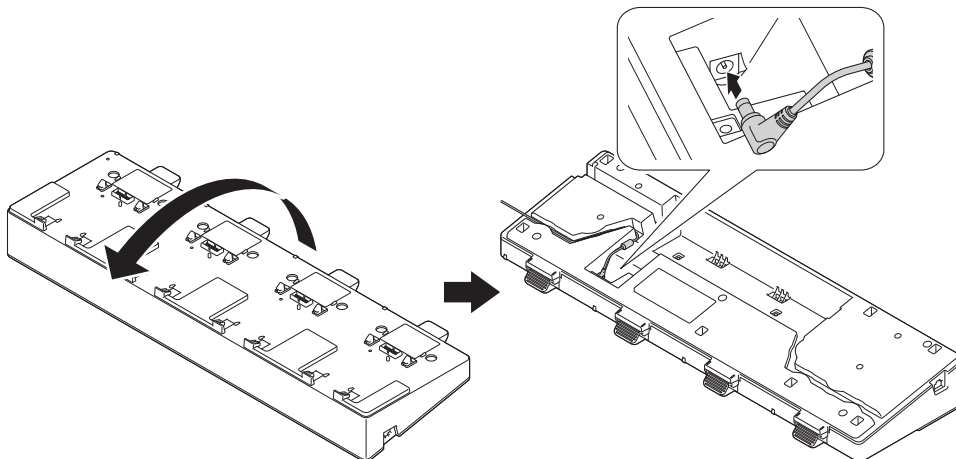

2. Connect the AC power cord to the AC Adapter.
3. Connect the AC power cord to a nearby electrical socket.

4. Align the Charging Cradle Terminals of the Charging Cradle and the printer.

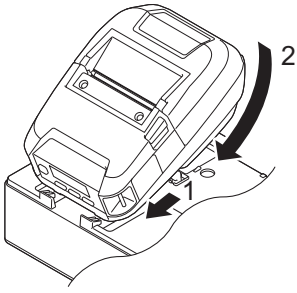

5. Press the printer down and onto the Charging Cradle until the latches lock it firmly in place.
The printer's LED Indicator lights in orange when charging.

The printer's LED Indicator will turn off when charging is complete.

Remove the Printer from the Charging Cradle

Push the Eject Button on the back of the Charging Cradle, lift the printer, and then remove it from the Charging Cradle.

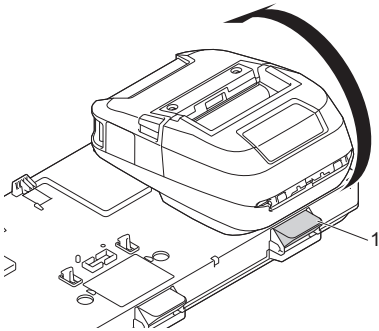

1. Eject Button

✓ Related Information

- [4-bay Charging Cradle \(Optional:PA-4CR-003\)](#)

Connect the Printer to a Wired LAN Network via 4-bay Charging Cradle

Related Models: RJ-3235B/RJ-3255WB

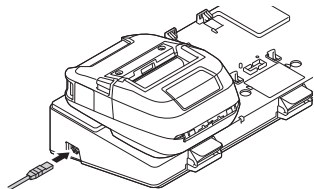

Use an Ethernet (LAN) connection to configure your printer and upgrade its firmware.



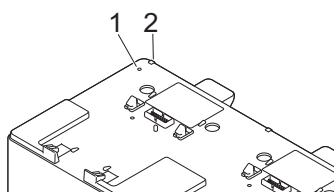

LED Indicators



1. Ethernet (LAN) LED

LED Indicator	Status
	Ethernet (LAN) not connected
	Ethernet (LAN) connected
	Receiving or sending data via Ethernet (LAN)

2. Status LED

LED Indicator	Status
	The printer is placed on the 4-bay Charging Cradle and the rechargeable Li-ion battery is fully charged.
	The printer is charging via 4-bay Charging Cradle

Interface Compatibility

Use the [WLAN] and [Wired LAN] menus to select WLAN, Wired LAN, or no connection when the printer is on the 4-bay Charging Cradle.

Cradle LAN Setting	WLAN Setting	Connection type when using the 4-bay Charging Cradle
On	On	WLAN →Wired LAN ¹
On	Off	No connection enabled →Wired LAN
Off	On	WLAN
Off	Off	No connection enabled

¹ Wireless Direct function is not affected.



Related Information

- [4-bay Charging Cradle \(Optional:PA-4CR-003\)](#)

Mount the 4-bay Charging Cradle on the Wall

Related Models: RJ-3235B/RJ-3255WB

1. Drill four holes in a commercially available board according to the spacing of the screw holes of the 4-bay Charging Cradle.

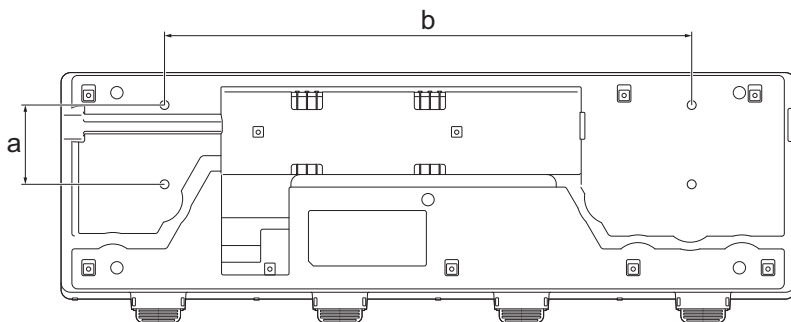

- a. Height: 61 mm
- b. Width: 406.4 mm

2. Affix the Charging Cradle to the board using four screws, as shown in the illustration.

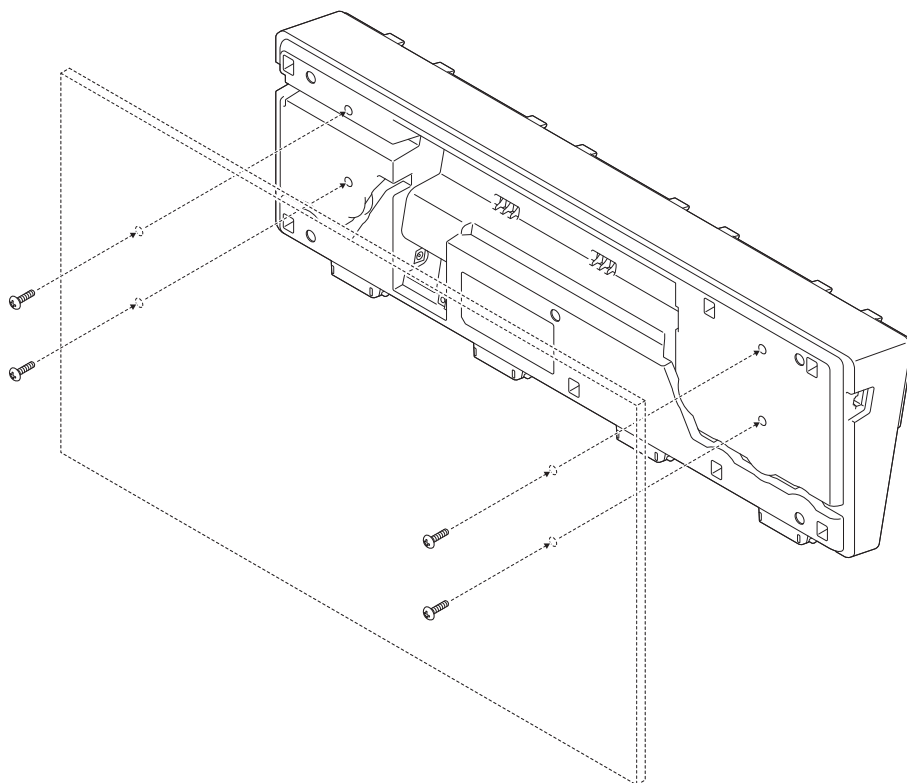

- Make sure you install the Charging Cradle in the correct direction so that the printer will not fall.
- Use M5 size screws.

3. Lean the board against the wall or secure the board to the wall.



Related Information

- [4-bay Charging Cradle \(Optional:PA-4CR-003\)](#)

Charging Cradle (Optional: PA-CR-002A)

Related Models: RJ-4235B/RJ-4255WB

- [Charging Cradle Overview \(Optional: PA-CR-002A\)](#)
- [Charge the Rechargeable Li-ion Battery Using the Charging Cradle \(Optional: PA-CR-002A\)](#)
- [Mount the Charging Cradle on the Wall \(Optional: PA-CR-002A\)](#)
- [Install the Mounting Arm on the Charging Cradle \(Optional: PA-CR-002A\)](#)

Charging Cradle Overview (Optional: PA-CR-002A)

Related Models: RJ-4235B/RJ-4255WB

Parts Description

Charging Cradle

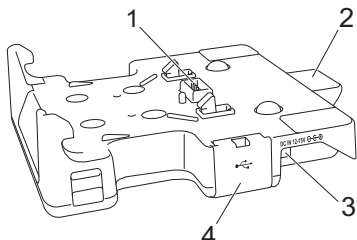

Charging Cradle Terminal Attachment

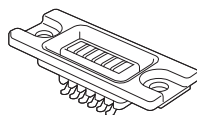

Screws (2)

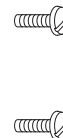

1. Charging Cradle Terminals
2. Eject Button
3. DC Connector
4. USB Port

(Allows to print from a mobile device or a computer by connecting it to the Charging Cradle using a USB cable.)

Specifications

Charging time	About 4 hours ¹
Charging temperature	From 5°C to 35°C
Operating temperature	AC adapter: From -10°C to 40°C Car adapter: From -10°C to 50°C
Operating humidity	From 10% to 90% (without condensation)

¹ Varies depending on the operating environment and the condition of the rechargeable Li-ion battery.

NOTE

- The Charging Cradle can be used without a rechargeable Li-ion battery as a power supply or for printing.
- Do not turn on the printer and the Charging Cradle simultaneously.
- Sequential printing and the mass storage mode are not supported when the Charging Cradle is used to print.
- When the printer is placed on the Charging Cradle, we recommend using the **After one page of data is received** setting in the **Other** tab of the printer driver properties before printing.



Related Information

- [Charging Cradle \(Optional: PA-CR-002A\)](#)

Related Topics:

- [Charging Cradle \(Optional\) Problems](#)

Charge the Rechargeable Li-ion Battery Using the Charging Cradle (Optional: PA-CR-002A)

Related Models: RJ-4235B/RJ-4255WB

The Charging Cradle (PA-CR-002A) cannot recharge the printer's rechargeable Li-ion battery without being connected to an electrical socket using the AC Adapter (PA-AD-600A).

- >> [Before Charging the Rechargeable Li-ion Battery](#)
- >> [Charge the Rechargeable Li-ion Battery](#)
- >> [Remove the Printer from the Charging Cradle](#)
- >> [Lock the Eject Button](#)

Before Charging the Rechargeable Li-ion Battery

1. Remove the Charging Cradle terminal cover with a flathead screwdriver.

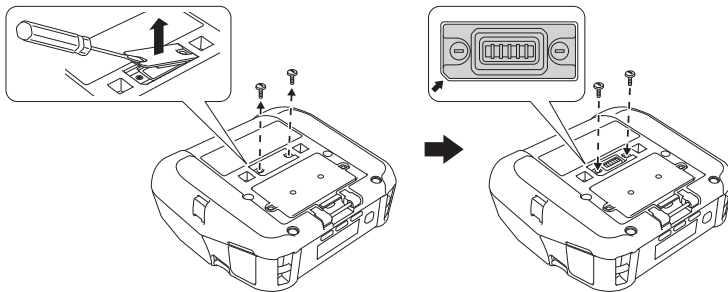

2. Install the Charging Cradle Terminal Attachment onto the printer using the Charging Cradle Terminal Attachment and screws included with the Charging Cradle.



Make sure the notched corner is aligned correctly.

Charge the Rechargeable Li-ion Battery

1. Connect the AC Adapter to the Charging Cradle's DC Connector.

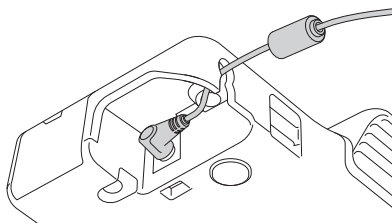

2. Connect the AC power cord to the AC Adapter.
3. Connect the AC power cord to a nearby electrical socket.
4. Align the Charging Cradle Terminals of the Charging Cradle and the printer.

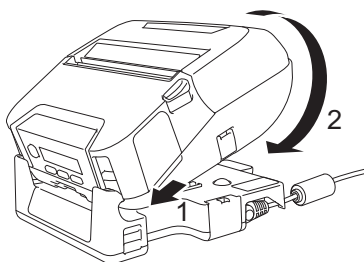

5. Press the printer down and onto the Charging Cradle until the latches lock it firmly in place.
The printer's LED Indicator lights in orange when charging.

The printer's LED Indicator will turn off when charging is complete.

Remove the Printer from the Charging Cradle

Push the Eject Button on the back of the Charging Cradle, lift the printer, and then remove it from the Charging Cradle.

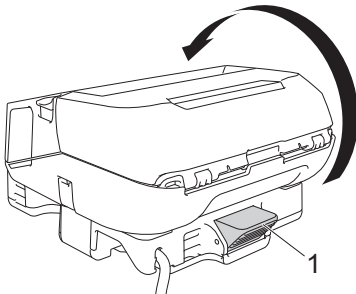

1. Eject Button

Lock the Eject Button

Insert a cotter pin (or similar) through the hole as illustrated below.



Use a Low Carbon Steel Extended Prong Retaining Cotter Pin (not included): Length: 50 mm, Pin Diameter: 2 mm

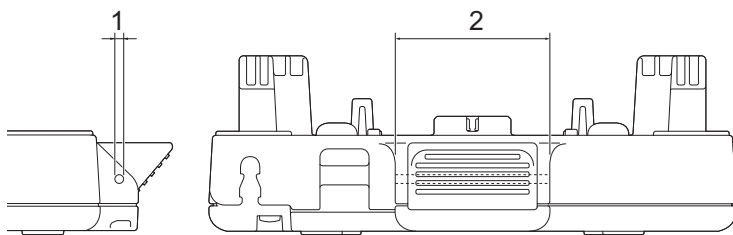
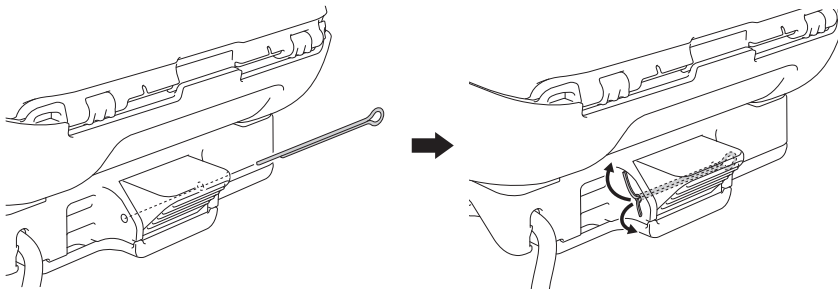

1. Diameter: 2.3 mm
2. Length: 41.2 mm



To purchase the Cotter Pin, contact your local Brother dealer.

✓ Related Information

- [Charging Cradle \(Optional: PA-CR-002A\)](#)

Mount the Charging Cradle on the Wall (Optional: PA-CR-002A)

Related Models: RJ-4235B/RJ-4255WB

Affix the Charging Cradle to the wall using four screws, as shown in the illustration.

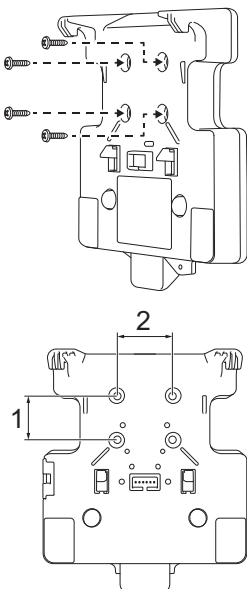

1. Height: 30 mm
2. Width: 38.1 mm



- Make sure you install the Charging Cradle in the correct direction so that the printer will not fall.
- Use screws with the following dimensions: Length: 25 mm or more, Diameter: 9.8 mm or less.



Related Information

- [Charging Cradle \(Optional: PA-CR-002A\)](#)

Install the Mounting Arm on the Charging Cradle (Optional: PA-CR-002A)

Related Models: RJ-4235B/RJ-4255WB

Optional Mounting Arms corresponding to the RAM-202U mount are offered for use with the Charging Cradle which allow a more versatile method of positioning the printer.

1. Secure one of the mounting flanges from the movable arm to the bottom of the Charging Cradle, with the four (4) #10 - 32 or #10 - 24 screws supplied with the Mounting Arm.
2. Secure the other mounting flange on the movable arm to the desired mounting surface.

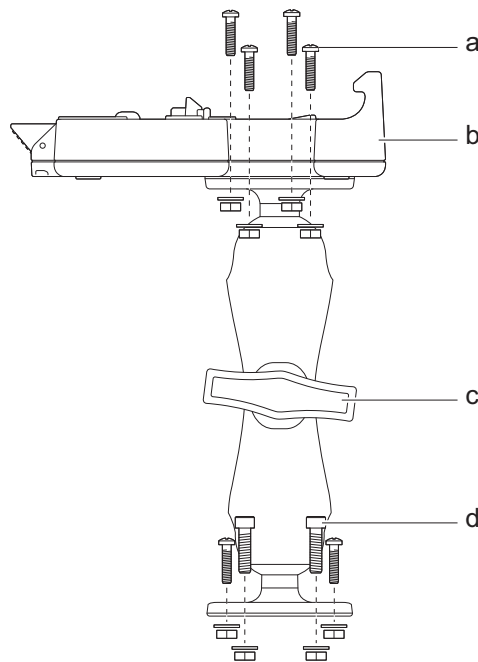
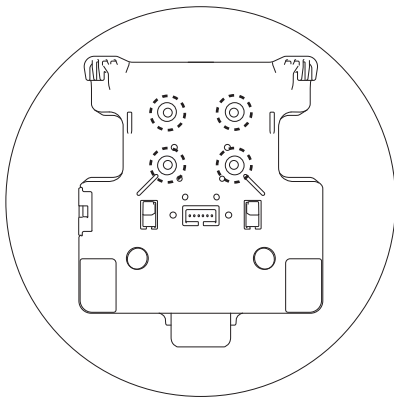

- a. Screw to secure to the Charging Cradle
- b. Charging Cradle
- c. Tightening Clamp
- d. Screw to secure to mounting surface

You can use the #10 - 24 x 19.05 mm screws and associated hardware supplied in the Mounting Arm Kit, or use other hardware suitable for the mounting conditions.

✓ Related Information

- [Charging Cradle \(Optional: PA-CR-002A\)](#)

Product Dimensions



All measured values are in millimeters.

- >> Printer (RJ-3235B/RJ-3255WB)
- >> Printer (RJ-4235B/RJ-4255WB)
- >> Battery Charger
- >> Charging Cradle (PA-CR-005)
- >> Charging Cradle (PA-CR-002A)
- >> 4-bay Charging Cradle

Printer (RJ-3235B/RJ-3255WB)

Front view / Back view

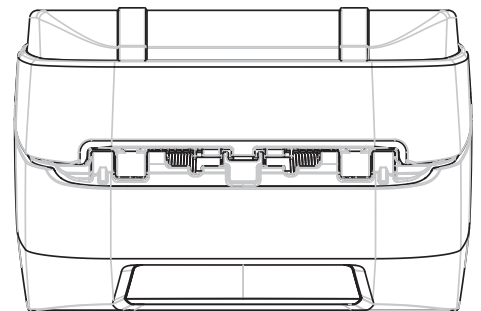
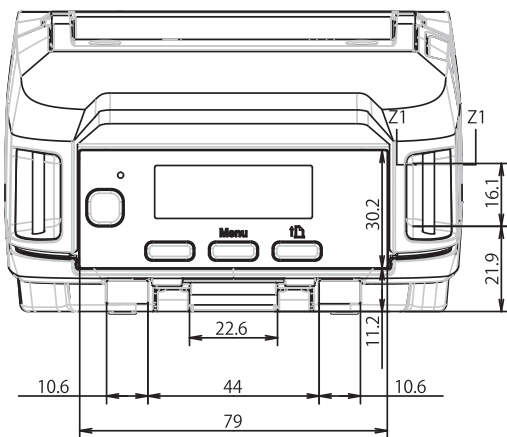

Top view / Bottom view

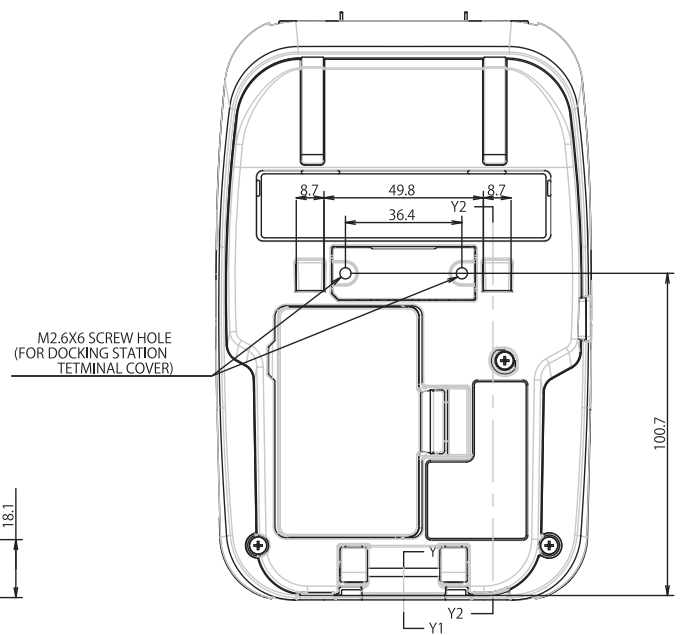
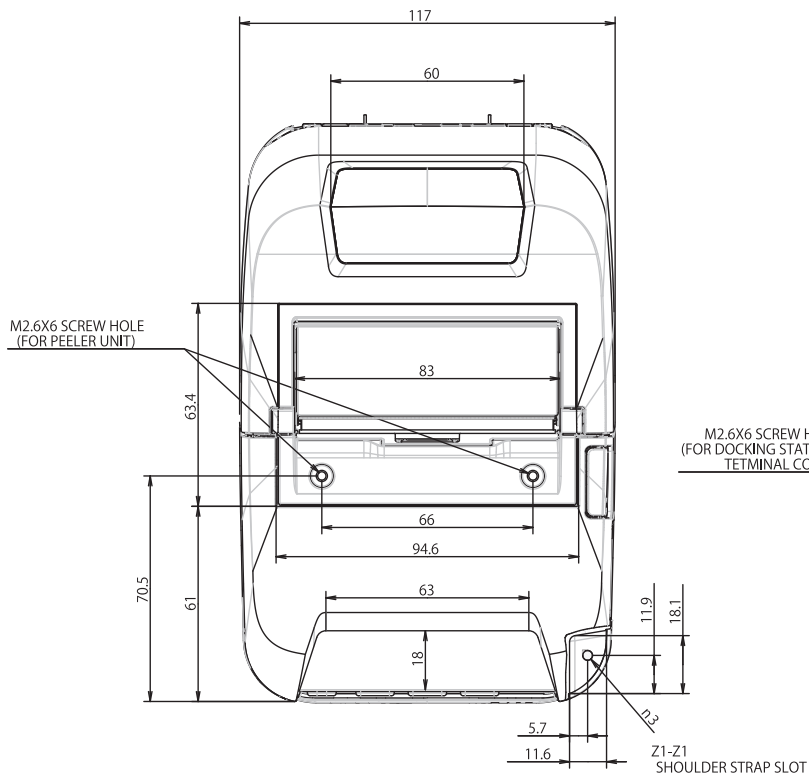

Side view

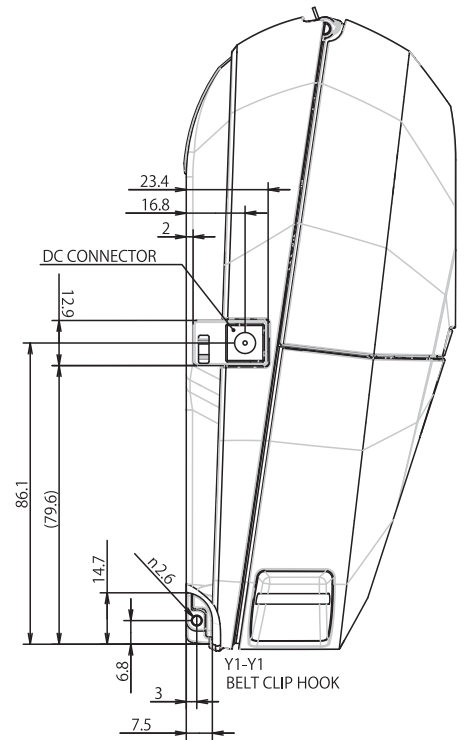
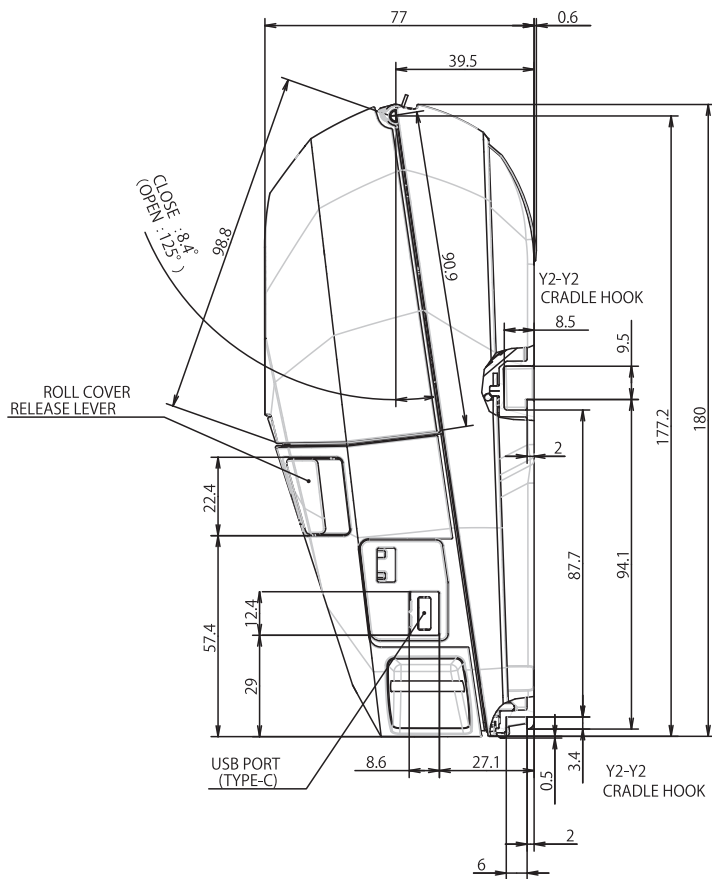

Printer (RJ-4235B/RJ-4255WB)

Front view / Back view

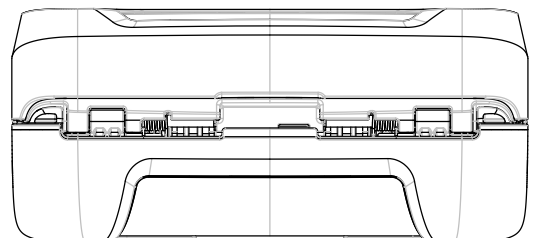
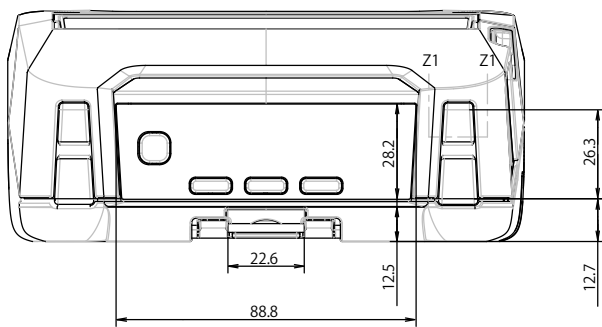

Top view / Bottom view

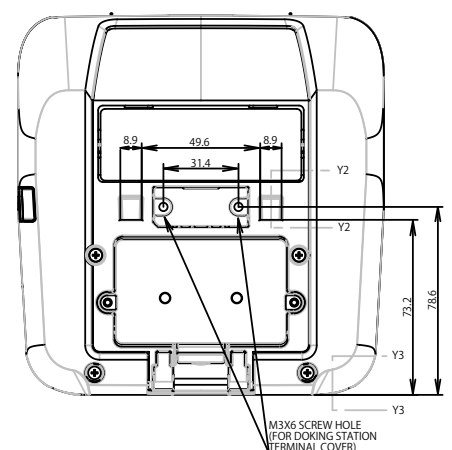
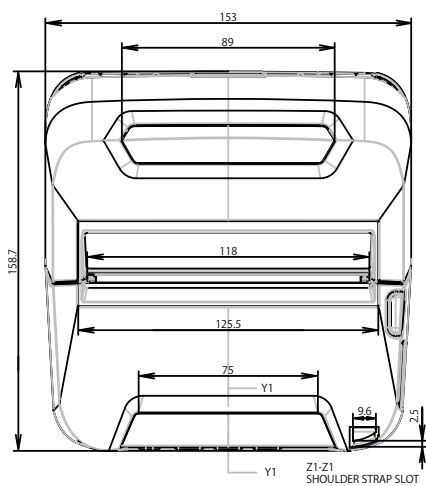

Side view

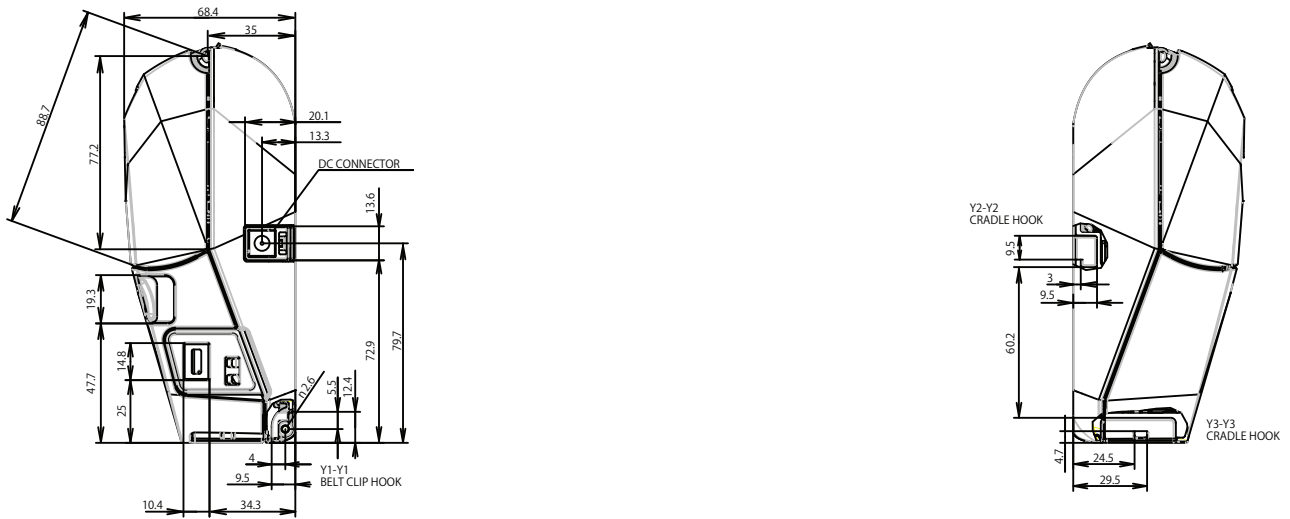

Battery Charger

Front view / Back view

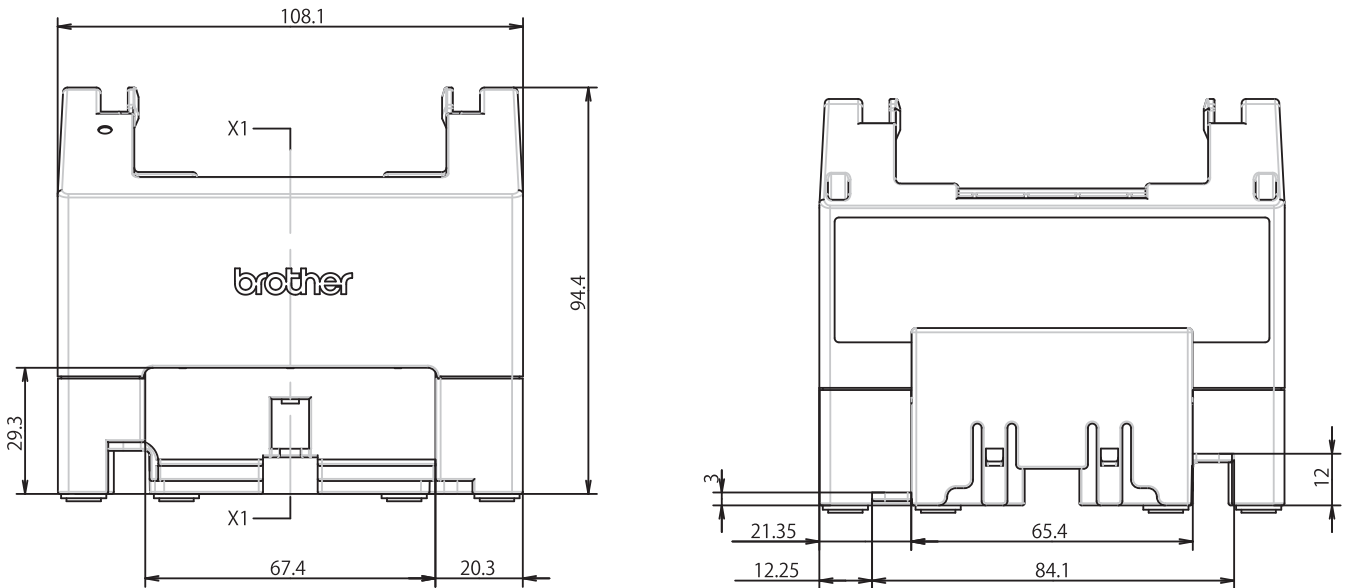

Top view / Bottom view

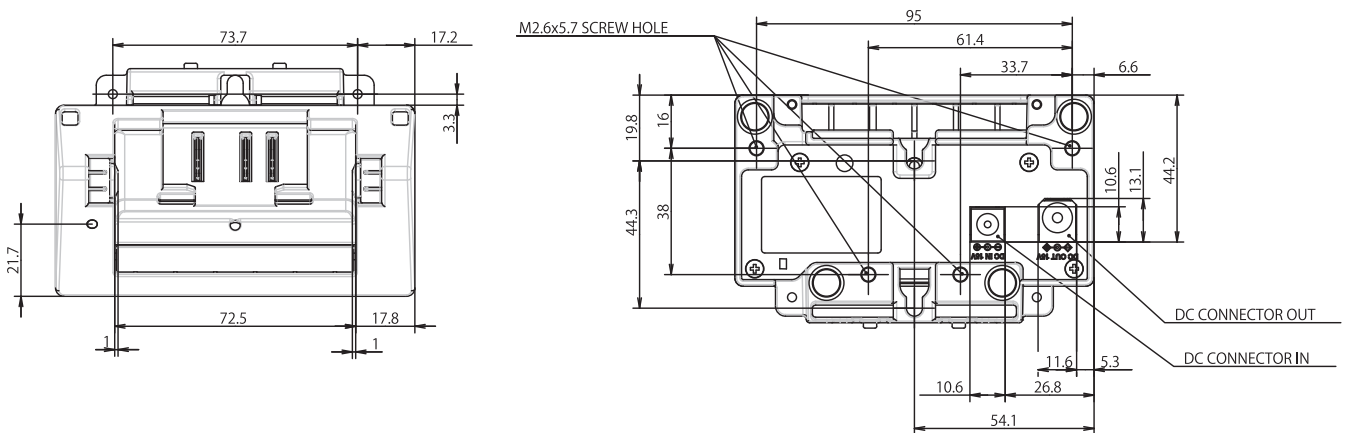

Side view

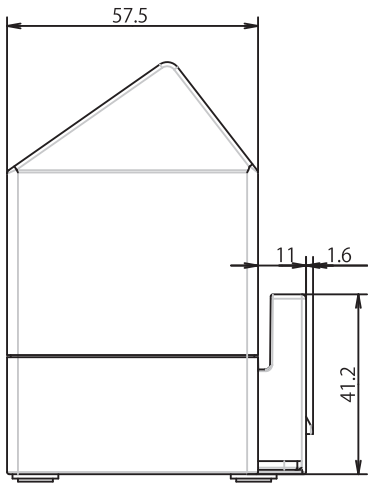

Cross section

X1-X1

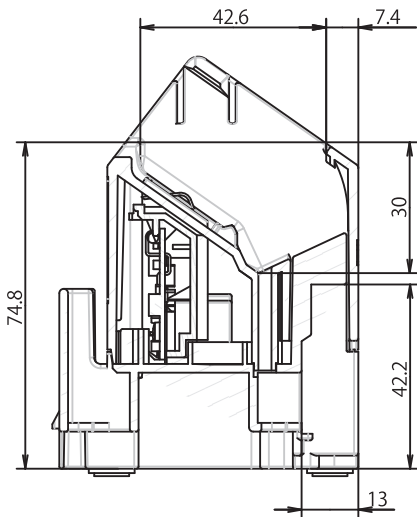

Charging Cradle (PA-CR-005)

Front view / Back view

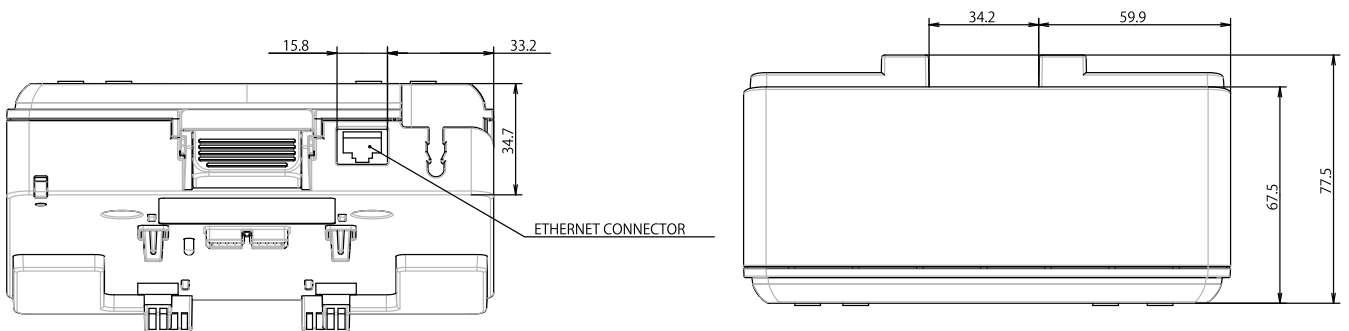

Top view / Bottom view

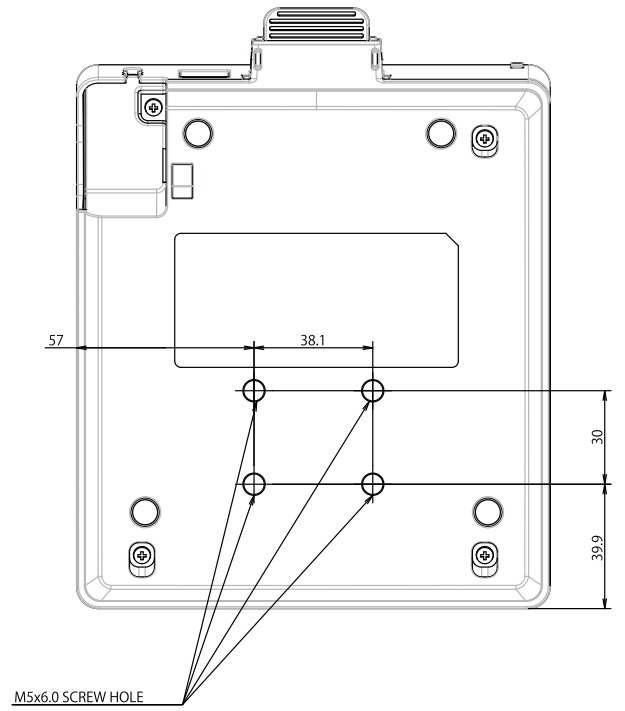
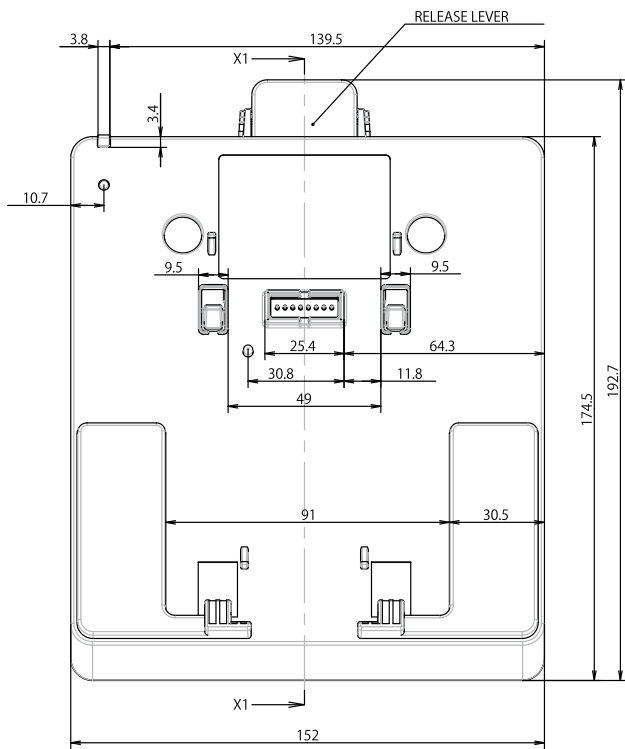

Side view

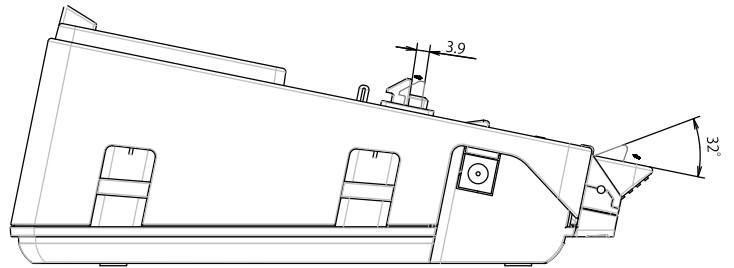
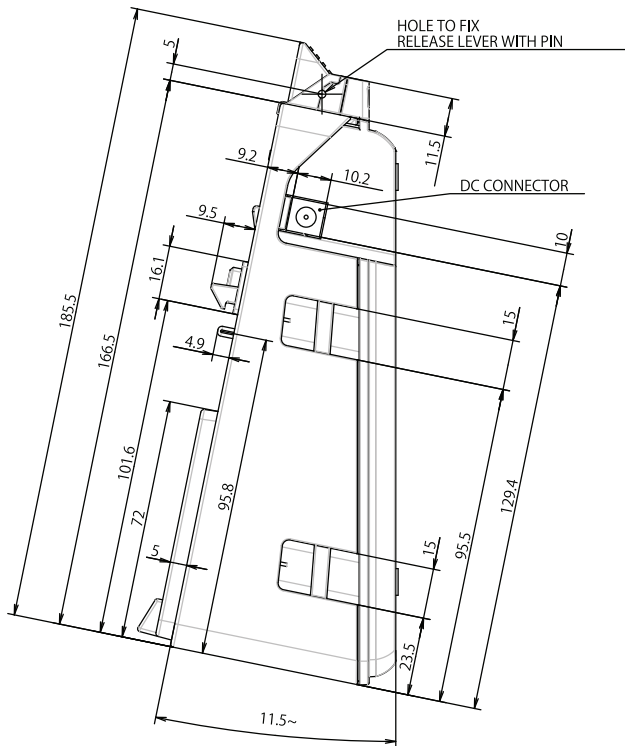

Cross section

X1-X1

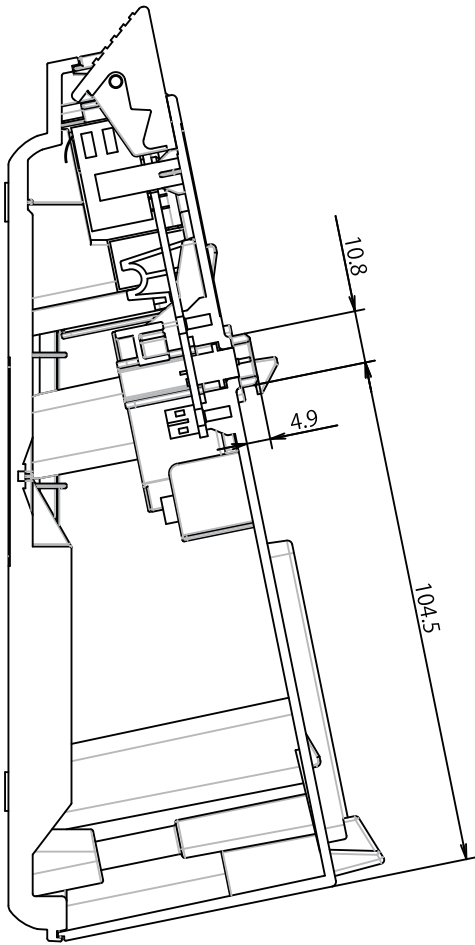

Charging Cradle (PA-CR-002A)

Front view / Back view

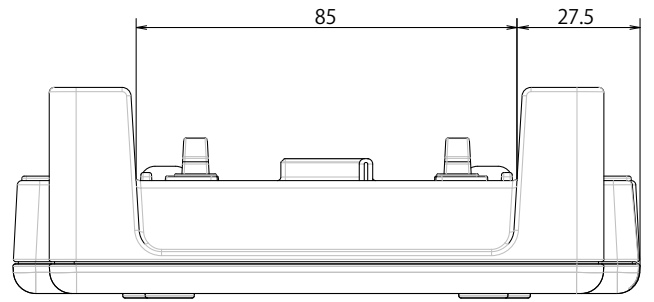
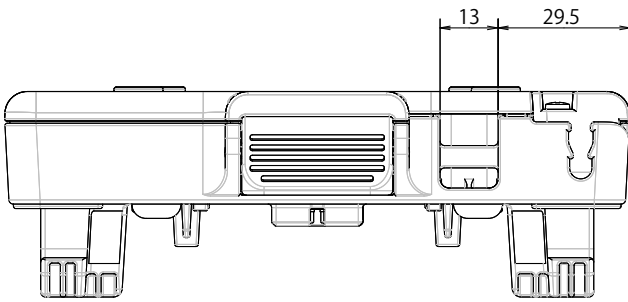

Top view / Bottom view

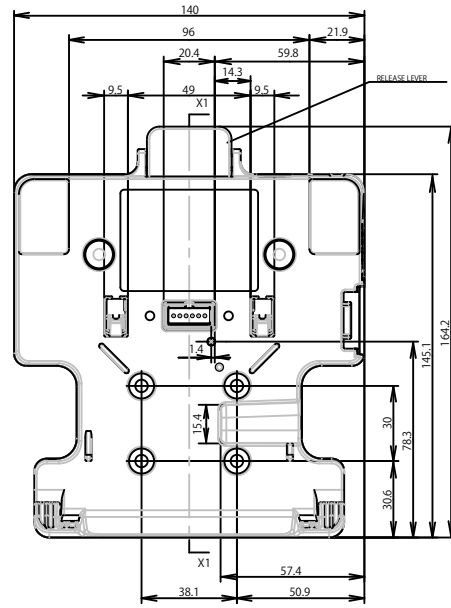
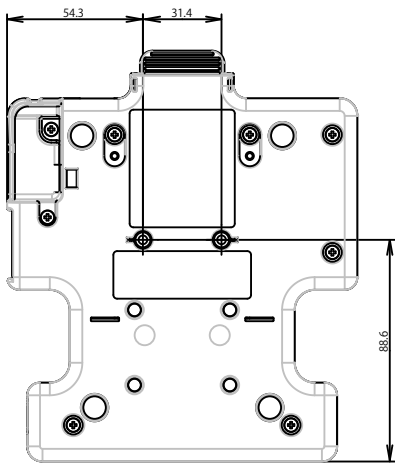

Side view

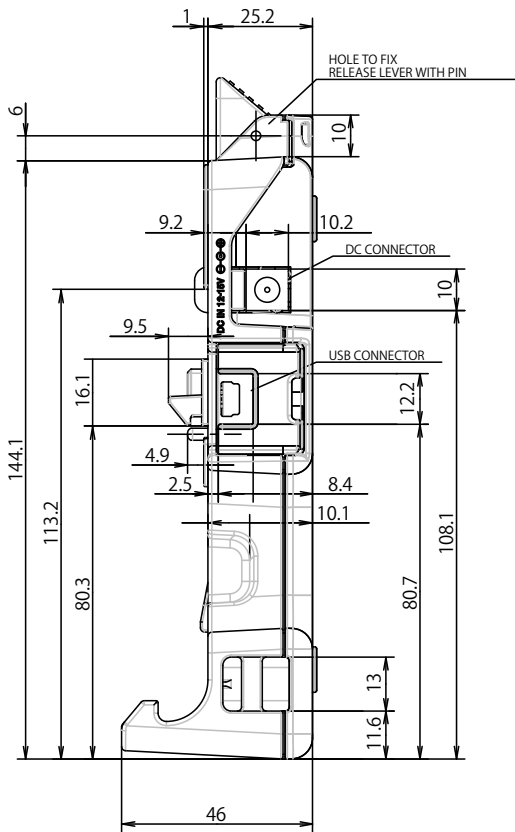

X1-X1

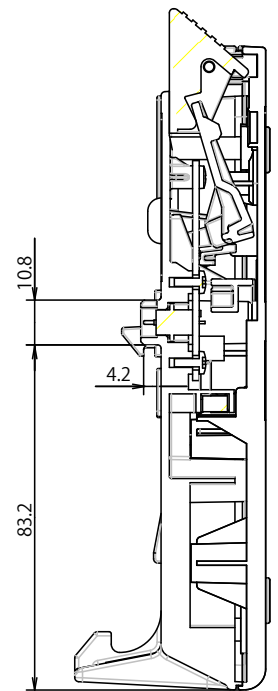

Cross section

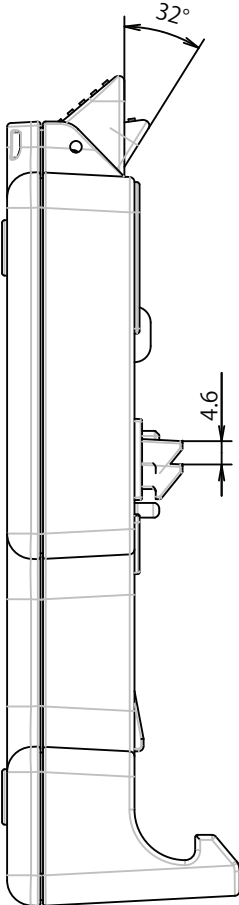

Back view

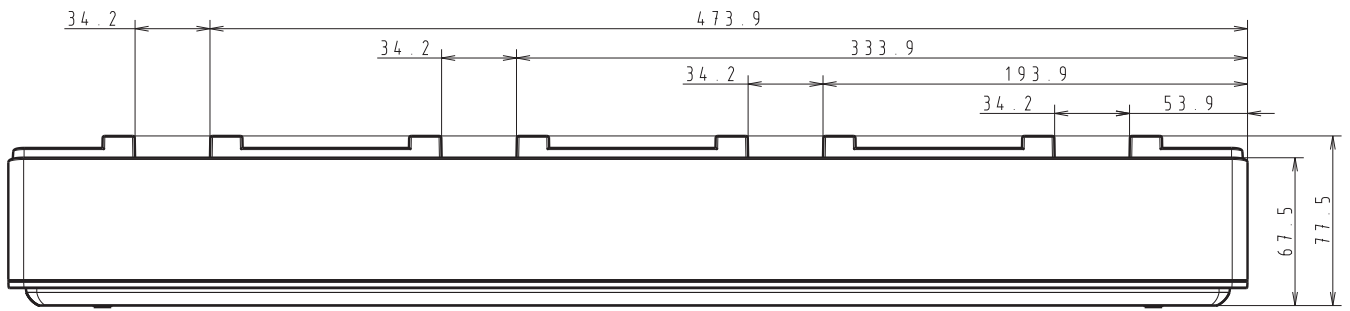

Side view

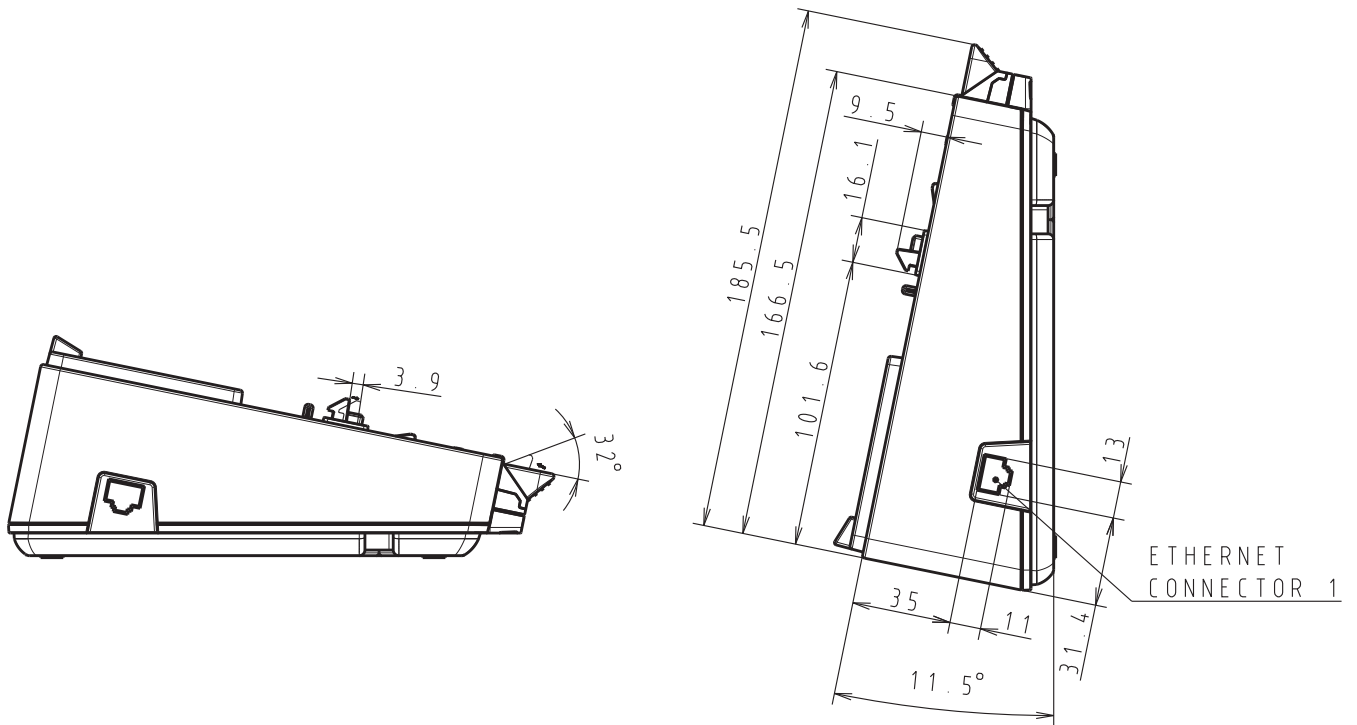

Cross section

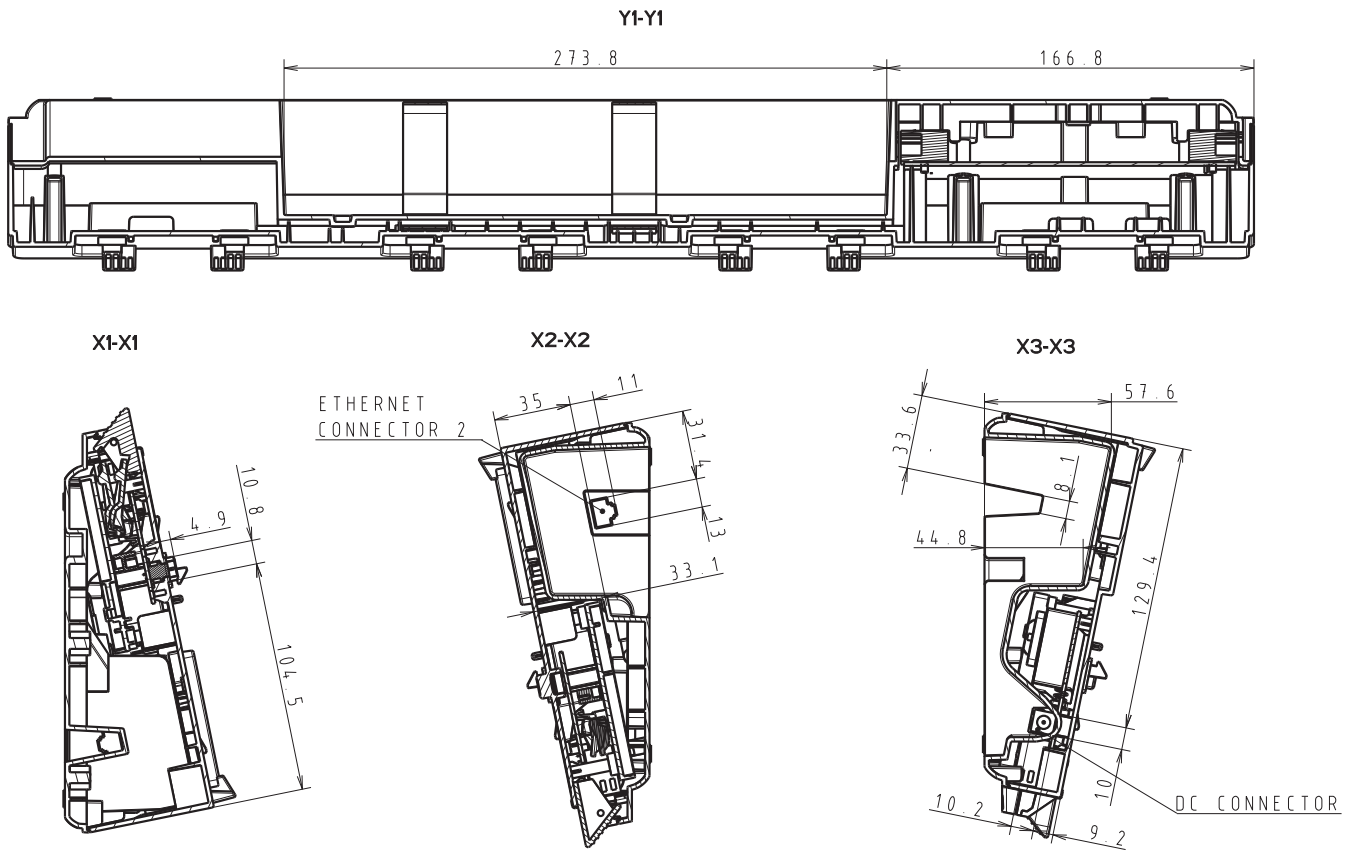

Related Information

- [Appendix](#)

Brother Help and Customer Support

If you need help with using your Brother product, visit support.brother.com for FAQs and troubleshooting tips. You can also download the latest software, drivers and firmware, to improve the performance of your machine, and user documentation, to learn how to get the most from your Brother product.

Further product and support information is available from your local Brother office website. Visit global.brother/en/gateway to find the contact details for your local Brother office and to register your new product.



Related Information

- [Appendix](#)
-

Compatible Operating Systems

For the latest list of compatible software, visit support.brother.com/os.



Related Information

- [Appendix](#)
-

brother

