

# Product Safety Guide

**MFC-J3660DW/MFC-J3960DW/MFC-J5010DW/MFC-J5110DW/MFC-J5115DW/MFC-J5117DW/  
MFC-J6560DW/MFC-J6960DW/MFC-J6975DW/MFC-J6977DW**

Read this guide before attempting to operate the product, or before attempting any maintenance, and ensure that you follow all warnings and instructions marked on the product. Brother shall not be liable for the damage caused where the product owner has failed to follow the instructions set out in this guide or on the product.

For more detailed instructions, information, and product specifications, see the *Online User's Guide* at [support.brother.com/manuals](http://support.brother.com/manuals).

## Symbols and Conventions Used in the Documentation

The following symbols and conventions are used throughout the documentation.

### WARNING

WARNING indicates a potentially hazardous situation which, if not avoided, could result in death or serious injuries.

### CAUTION

CAUTION indicates a potentially hazardous situation which, if not avoided, may result in minor or moderate injuries.

### IMPORTANT

IMPORTANT indicates a potentially hazardous situation which, if not avoided, may result in damage to property or loss of product functionality.



Prohibition icons indicate actions that must not be performed.



This icon indicates that flammable sprays must not be used.



This icon indicates that organic solvents/liquids such as alcohol must not be used.



Electrical Hazard icons alert you to the possibility of an electric shock.



Fire Hazard icons alert you to the possibility of a fire.



Explosion Hazard icons alert you to the possibility of an explosion.



This icon alerts you to the possibility of being injured by moving parts.



This icon alerts you to the areas that contain moving parts.

**Bold** Bold typeface identifies specific buttons on the product's control panel or on the computer screen.

*Italics* Italicised style emphasises an important point or refers you to a related topic.

*Courier New* Text in Courier New font identifies messages on the LCD of the product.

## Compilation and Publication Notice

Not all models are available in all countries.

In this guide, the illustrations of the following model is used unless otherwise specified:

MFC-J3960DW

These machines are approved for use in the country of purchase only. Local Brother companies or their dealers may only support machines purchased in their own countries.

This product's manuals have been compiled and published to provide the latest product safety information at the time of publication. The information contained in these manuals may be subject to change.

For the latest manuals, visit [support.brother.com](http://support.brother.com).

©2025 Brother Industries, Ltd. All rights reserved.

## Choose a Safe Location for Your Product

### WARNING



- Choose a location where the temperature remains between 10°C and 35°C, the humidity is between 20% and 80%, and where there is no condensation.
- DO NOT expose the product to direct sunlight, excessive heat, open flames, corrosive gasses, moisture, or dust.
- DO NOT place the product near chemicals or in a place where chemicals could be spilled on it. In particular, organic solvents or liquids such as benzene, paint thinner, polish remover, or deodoriser may melt or dissolve the plastic cover and/or cables. These or other chemicals may cause the product to malfunction or become discoloured.



Do not install or use in areas where explosive or electrically conductive dusts are generated.

Make sure you place this product on a stable and level surface free from vibration and shocks. The product is heavy and may fall, causing injury to you or others and serious damage to the product.

### CAUTION



- Install the product near a telephone socket (models with the fax function only) and a standard grounded electrical socket.
- Install the product in a safe location where it cannot be accidentally knocked over.
- Ensure that cables and cords are secured so as not to pose a tripping hazard.
- DO NOT place heavy objects on the product.
- DO NOT place any objects around the product that may block access to the electrical socket. It is important that the product can be unplugged whenever needed.

## IMPORTANT

- DO NOT place your product next to devices that contain magnets or generate magnetic fields. Doing so may interfere with the operation of the product, causing print quality problems.
- DO NOT tilt the product if the ink cartridges are installed, to avoid ink spillage and internal damage to the product.
- DO NOT place your product next to sources of interference, such as speakers or the base units of cordless telephones. Doing so may interfere with the operation of the product's electronic components.
- DO NOT place anything in front of the product that will block printed pages or received faxes (models with the fax function only).



## Connect the Product Safely

### ⚠ WARNING

	<ul style="list-style-type: none"> <li>• There are high-voltage electrodes inside the product. Before cleaning or other routine maintenance of your product, disconnect the telephone line cord first, and then unplug the power cord and disconnect all other cables.</li> <li>• Always make sure the plug is fully inserted. DO NOT use the product if the power cord has become worn or frayed.</li> <li>• DO NOT drop any metal objects or any type of liquid on the product's power plug.</li> <li>• Connect this product to an AC power source within the range shown on your machine's rating label. DO NOT connect it to a DC power source, inverter or UPS (uninterruptible power supply). If you are not sure what kind of power source you have, contact a qualified electrician.</li> </ul>
	<p>DO NOT handle the plug with wet hands.</p>
	<p>To prevent the accumulation of dust, unplug the power plug regularly to clean it. Use a dry cloth to clean the base of the plug pins and between the pins.</p>

## Use the Product Safely

### ⚠ WARNING

	<ul style="list-style-type: none"> <li>• DO NOT dismantle this product.</li> <li>• DO NOT attempt to service this product yourself. Opening or removing covers may expose you to dangerous voltage points and other risks and may void your warranty. Refer all servicing to Brother customer service or your local Brother dealer.</li> <li>• If the product has been dropped or the casing has been damaged, there may be the possibility of an electric shock. Unplug the product from the electric socket and contact Brother customer service or your local Brother dealer.</li> <li>• If water, other liquids, or metal objects get inside the product, immediately unplug the product from the electrical socket and contact Brother customer service or your local Brother dealer.</li> <li>• If the product becomes unusually hot, releases smoke, or generates any strong smells, immediately unplug the product from the electrical socket. Contact Brother customer service or your local Brother dealer.</li> </ul>
	<p><b>Power Cord Safety</b></p> <ul style="list-style-type: none"> <li>• This product is equipped with an earthed plug. This plug will only fit into an earthed electrical socket. This is a safety feature. If you are unable to insert the plug into the socket, ask your electrician to replace your obsolete socket.</li> </ul>

- DO NOT allow anything to rest on the power cord.
- DO NOT place this product where others might step on the cord.
- DO NOT place this product in a position where the cord is stretched as it may become worn or frayed.
- DO NOT use the product or handle the cord if the cord has become worn or frayed. If unplugging your product, DO NOT touch the damaged/frayed part.
- DO NOT pull on the middle of the power cord; pulling on the middle may cause the cord to separate from the plug.
- DO NOT use unsupported hardware. Cables must meet the cable specifications described in the *Specifications* chapter of the *Online User's Guide*.
- Brother strongly recommends that you DO NOT use any type of extension cord.
- If the power cord is provided with this product, use ONLY the provided cord. Installation must be performed correctly as described in the *Quick Setup Guide*.

	<ul style="list-style-type: none"> <li>• DO NOT use or install this product during a thunderstorm.</li> <li>• (Models with the fax function only) Use caution when installing or modifying telephone lines. Never touch telephone wires or terminals that are not insulated unless the telephone line has been unplugged from the wall socket. Never install a telephone wall socket in a location that is wet or may become wet.</li> </ul>
---	--

	<p>DO NOT use flammable substances, any type of spray, or an organic solvent/liquid containing alcohol or ammonia to clean the inside or outside of the product. Instead, use only a dry, lint-free cloth. For instructions on how to clean the product, see the <i>Online User's Guide</i>.</p>
---	--

- (Models with the Wireless LAN function only) DO NOT use the product near any medical electrical equipment. The radio waves emitted from the product may affect medical electrical equipment and cause a malfunction, which may result in accident or injury.
- For users with pacemakers: This product generates a weak magnetic field. If you feel anything wrong with the operation of your pacemaker when near the product, move away from the product and consult a doctor immediately.

Plastic bags are used in the packing of this product. Plastic bags are not toys. To avoid the danger of suffocation, keep these bags away from babies and children, and dispose of them correctly.

### ⚠ CAUTION

Wait until pages have exited the product before picking them up. Failure to do this may cause injury to your fingers by trapping them inside the machine.

Keep your hands and any objects away from the ink insertion slot.

To prevent injury or product damage, position the product safely to avoid the product being accidentally knocked over.

- If the trays are extended, as shown, position the product so that the trays do not extend past the edge of the surface on which the product sits.

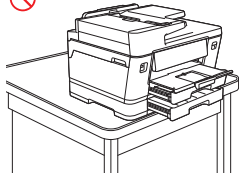
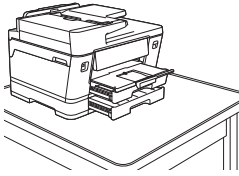

- MFC-J5010DW/MFC-J5110DW/MFC-J5115DW/MFC-J5117DW:  
If the flap (1) is open, as shown, position the product so that the flap does not extend past the edge of the surface on which the product sits.

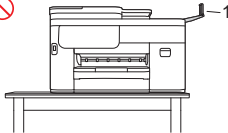
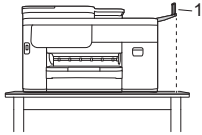

To prevent injuries, keep your hands away from the areas shown in the illustrations.

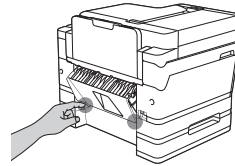
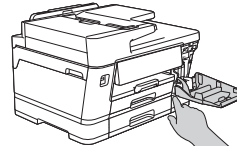
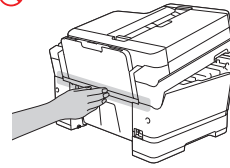
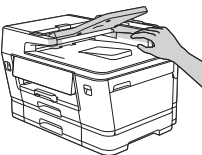
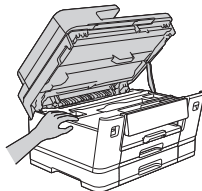
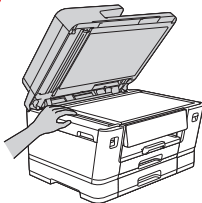

When changing the tray size from the large paper size to the original size, be careful not to trap your fingers in the gaps or slots in the bottom of the tray.

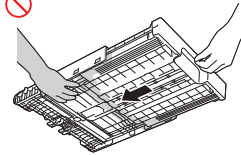
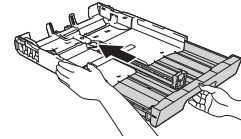

MFC-J3660DW/MFC-J3960DW/MFC-J6560DW/MFC-J6960DW/MFC-J6975DW/MFC-J6977DW:  
Keep your hands away from the areas shown in the illustration.

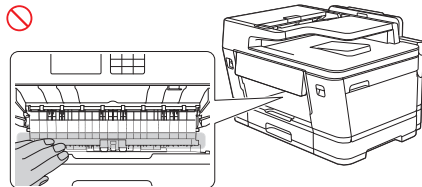

MFC-J3660DW/MFC-J3960DW/MFC-J5110DW/MFC-J5115DW/MFC-J5117DW/MFC-J6560DW/MFC-J6960DW/MFC-J6975DW/MFC-J6977DW:  
To prevent possible injuries, at least two people should lift the product. One person should stand in front of the product, and another person should stand behind it, as shown in the illustration below. Carry the product by sliding your hands into the handhold indentations located

on each side of the product. Be careful not to trap your fingers when you put the product down.

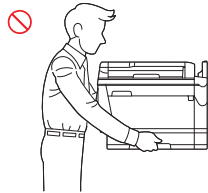
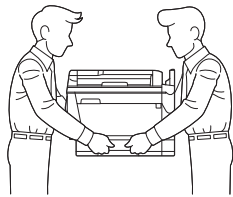

DO NOT carry the product by holding the areas shown in the illustrations. Doing this may cause the product to slip out of your hands and may result in injury.

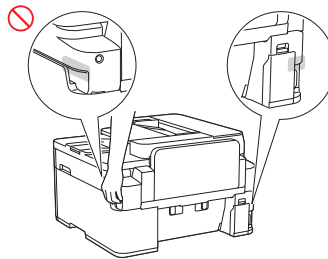
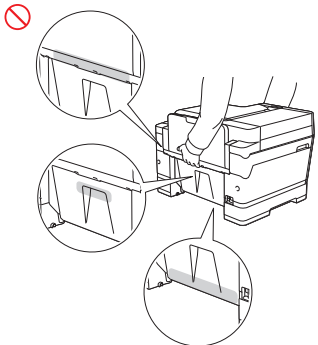
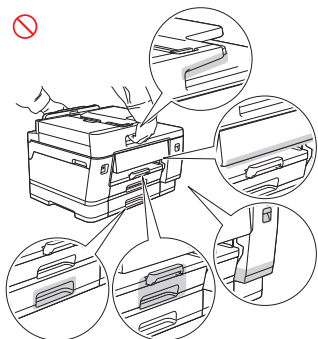
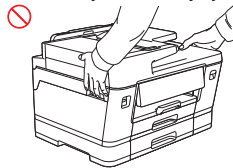

- **MFC-J5010DW:**  
Carry the product by sliding your hands into the handhold indentations located on each side of the product.



- When carrying the product, remove the trays if they have been extended to hold large paper. The weight of the paper could cause the trays to fall and cause injury to you or others.

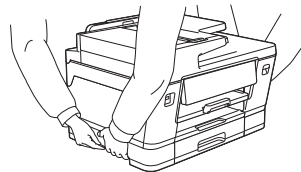

When multiple devices, including this product, are connected to a computer using USB cables, you may feel an electric charge when you touch metal parts of the product.

- Be careful not to get the ink in your eyes when replacing ink cartridges.
- Keep ink cartridges out of the reach of children.
- Avoid swallowing ink.
- DO NOT shake ink cartridges unless specifically instructed to do so. Ink may leak if the cartridge is shaken.
- DO NOT dismantle ink cartridges. The ink may get in your eyes, or on your skin.

If the ink contacts your skin or gets into your eyes or mouth, follow these steps immediately:

- If your skin comes into contact with the ink, wash your skin with water and soap immediately.
- If the ink gets into your eyes, rinse them with water, and consult your doctor immediately. If left untreated, it may cause redness or mild inflammation of the eyes.
- If the ink gets into your mouth or you swallow it, spit it out, rinse your mouth, and consult your doctor immediately. Failure to seek medical attention could lead to sickness.

DO NOT run your hand over the edge of the paper. The thin and sharp edges of the paper may cause an injury.

## ⚠ CAUTION

- MFC-J3660DW/MFC-J3960DW/MFC-J6560DW/MFC-J6960DW/MFC-J6975DW/MFC-J6977DW:  
DO NOT remove or damage any of the caution or warning labels inside the product.

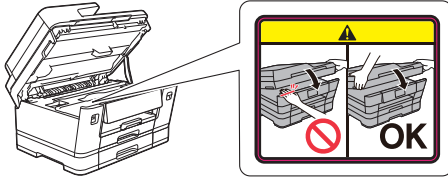

- Moving parts are located in the grey-shaded areas shown in the illustration. Keep your hands away from those areas when the parts are moving.  
DO NOT remove or damage any of the caution or warning labels inside the product.

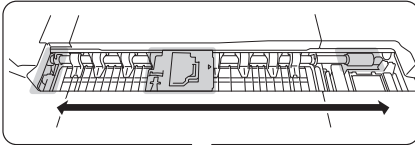

## IMPORTANT

- A distinct change in the product's performance may indicate a need for service.
- DO NOT connect your product to an electrical socket controlled by wall switches or automatic timers, or to the same circuit as a large appliance or other equipment that requires a significant amount of electricity. It could disrupt the power supply. Disruption of the power supply may also delete information from the product's memory, and repeated cycling of the power supply can damage the product.
- If the product does not operate normally when the operating instructions are followed, adjust only those controls that are covered by the operating instructions. Incorrect adjustment of other controls may result in damage and will often require extensive work by a qualified technician to restore the product to normal operation.

## Product Warranty & Liability

Nothing in this guide shall affect any existing product warranty or be construed as granting any additional product warranty. Failure to follow the safety instructions in this guide may invalidate your product's warranty.

## ⚠ WARNING



- Only use the power cord supplied with this product (if included in the box).
- This product must be installed near an electrical socket that is easily accessible. In case of an emergency, you must unplug the power cord from the electrical socket to shut off the power completely.

## Declaration of Conformity (Europe Only)

We, Brother Industries, Ltd.

15-1, Naeshiro-cho, Mizuho-ku, Nagoya 467-8561 Japan declare that this product is in conformity with the relevant EU harmonization legislation (Europe only) and UK legislation (Great Britain only).

The Declaration of Conformity (DoC) can be downloaded from our website. Visit [support.brother.com/manuals](http://support.brother.com/manuals).

## EU Declaration of Conformity for RE Directive 2014/53/EU (Europe Only) (Applicable to Models with Radio Interfaces)

We, Brother Industries, Ltd.

15-1, Naeshiro-cho, Mizuho-ku, Nagoya 467-8561 Japan declare that these products are in conformity with the provisions of the RE Directive 2014/53/EU. A copy of the Declaration of Conformity can be downloaded by following the instructions in the Declaration of Conformity (Europe Only) section.

## LAN Connection (Models with the Wired LAN Function Only)

## ⚠ CAUTION

DO NOT connect this product to a LAN connection that is subject to overvoltages.

## For Models with FAX Function (New Zealand Only)

1. The grant of a Telepermit for any item of terminal equipment indicates only that Telecom has accepted that the item complies with minimum conditions for connection to its network. It indicates no endorsement of the product by Telecom, nor does it provide any sort of warranty. Above all, it provides no assurance that any item will work correctly in all respects with another item of Telepermitted equipment of a different make or model, nor does it imply that any product is compatible with all of Telecom's network services.
2. This equipment does not fully meet Telecom's impedance requirements. Performance limitations may occur when used in conjunction with some parts of the network. Telecom will accept no responsibility should difficulties arise in such circumstances.
3. This equipment should not be used under any circumstances which may constitute a nuisance to other Telecom customers.
4. This equipment shall not be set up to make automatic calls to the Telecom "111" Emergency Service.
5. This equipment is not capable, under all operating conditions, of correct operation at the higher speeds for which it is designed. Telecom will accept no responsibility should difficulties arise in such circumstances.
6. Some parameters required for compliance with Telecom's Telepermit requirements are dependent on the equipment (PC) associated with this device. The associated equipment shall be set to operate within the following limits for compliance with Telecom's Specifications:
  - There shall be no more than 10 call attempts to the same number within any 30 minute period for any single manual call initiation.
  - The equipment shall go on-hook for a period of not less than 30 seconds between the end of one attempt and the beginning of the next call attempt.
  - Automatic calls to different numbers are spaced such that there is no less than 5 seconds between the end of one call attempt and the beginning of another.
  - Equipment shall be set to ensure that calls are answered between 3 and 30 seconds of receipt of ringing.
7. Many CPE devices have features such as "last number redial" or "memory dial" which depend on a small on-hook line current for the maintenance of memory information. Such terminal devices used with the series connected device may lose their memory functions.
8. Telepermitted equipment only may be connected to the EXT telephone port. This port is not specifically designed for 3-wire-connected equipment. 3-wire-connected equipment might not respond to incoming ringing when attached to this port.
9. In the event of any problem with this device, it is to be disconnected, and a CPE item connected to one of its

terminal ports may be connected directly in its place. The user should then arrange for the product to be repaired. Should the matter be reported to Telecom as a wiring fault, and the fault is proven to be due to this product, a call-out charge will be incurred by the customer.

10. If a charge for local calls is unacceptable, the "Dial" button should NOT be used for local calls. Only the 7-digits of the local number should be dialed from your telephone. DO NOT dial the area code digit or the "0" prefix.
11. This equipment may not provide for the effective hand-over of a call to another device connected to the same line.
12. This unit will only work in conjunction with a tone signalling (DTMF) telephone, but some telephones may not be compatible. Since noise or speech from the telephone can upset dialling from this unit, errors may result if the devices are used together in other than quiet conditions.
13. Where it is necessary to dial prefix digits, such as a Caller Display override code ("0196" or "0197"), this unit will have to be used in conjunction with an associated tone signalling (DTMF) telephone.
14. Note that some telephones are NOT compatible with this unit and dialling errors may result if the two devices are used together in other than quiet conditions. The Telecom Faults Service is NOT to be called should such problems arise. In such cases, it is recommended that the prefix and wanted number are dialled manually.
15. The answer delay setting of this equipment shall not be set to less than the default setting as this will destroy Caller ID information.
16. The caller ID telephone numbers which are displayed and stored in this equipment include the caller's area code or cellular code but do not include the toll access "0" prefix. When calling back it is necessary to add a "0" to the telephone number, or if the telephone number is a local number, omit the area code digit. If the toll services of a service provider other than Telecom are being used then a toll charge may be incurred if the "0" prefix toll access code and area code are used.
17. When using the Caller Line Identification incorporated in this device, verify the integrity of the recorded digits prior to dialling.

## For WLAN models (Taiwan only)

### Caution!

Without permission granted by the NCC, any company, enterprise, or user is not allowed to change frequency, enhance transmitting power or alter original characteristic as well as performance to a approved low power radio-frequency devices. The low power radio-frequency devices shall not influence aircraft security and interfere legal communications; If found, the user shall cease operating immediately until no interference is achieved. The said legal communications means radio communications is operated in compliance with the Telecommunications Management Act. The low power radio-frequency devices must be susceptible with the interference from legal communications or ISM radio wave radiated devices. Avoid affecting the operation of nearby radar systems.

## Compliance Statement of Wireless equipment (Thailand only)

เครื่องโทรคมนาคมและอุปกรณ์นี้มีความสอดคล้องตามมาตรฐานหรือข้อกำหนดทางเทคนิคของ กสทช.

This telecommunication equipment conforms to the standard or technical requirements of NBTC.

เครื่องวิทยุคมนาคมนี้มีระดับการแผ่คลื่นแม่เหล็กไฟฟ้าสอดคล้องตาม มาตรฐานความปลอดภัยต่อสุขภาพของมนุษย์จากการใช้เครื่องวิทยุคมนาคมที่คณะกรรมการกิจการ โทรคมนาคมแห่งชาติประกาศกำหนด

This radiocommunication equipment has the electromagnetic field strength in compliance with the Safety Standard for the Use of Radiocommunication Equipment on Human Health announced by the National Telecommunications Commission.

## Recycling information in accordance with the India E-Waste (Management) Rules (India only)



### India only

This product is RoHS compliant and meets the requirements of the India E-Waste (Management) Rules. The above recycling symbol means that at the end of the life of the equipment, you must dispose of it separately at an appropriate collection point, and not place it in the normal domestic unsorted waste stream. This will benefit the environment for all. For detailed information, please refer to the following Brother India website: <https://www.brother.in/>

For inquiries on the collection program, please call Toll Free: 1800 222422 or 1800 2098904 (Between 9AM-5PM Mon-Sat).

## Declaration of the Presence Condition of the Restricted Substances Marking (Taiwan Only)

We, Brother Industries, Ltd.

15-1 Naeshiro-cho, Mizuho-ku, Nagoya 467-8561 Japan

Disclaimer This product complies with the Taiwan RoHS Certification Practice.

The "Declaration of the Presence Condition of the Restricted Substances Marking" can be download from our website, Visit [support.brother.com/g/d/afm4/](http://support.brother.com/g/d/afm4/) and:

-> Select a product category

-> Select the product model.

The "Declaration of the Presence Condition of the Restricted Substances Marking" will be downloaded as a PDF file.

## Trademarks

Wi-Fi® and Wi-Fi Direct® are registered trademarks of Wi-Fi Alliance®.

Mac is a trademark of Apple Inc., registered in the U.S. and other countries.

QR Code is a registered trademark of DENSO WAVE INCORPORATED in Japan and in other countries.

Each company whose software title is mentioned in this manual has a Software Licence Agreement specific to its proprietary programs.

**Any trade names and product names of companies appearing on Brother products, related documents and any other materials are all trademarks or registered trademarks of those respective companies.**

## Customer Service and Service Centre Locations

Visit [global.brother/en/gateway](http://global.brother/en/gateway).

## Unlawful Use of Copying or Scanning Equipment (Products with the scanning function only)

It is an offence to make reproductions of certain items or documents with the intent to commit fraud. The following is a non-exhaustive list of documents which it may be unlawful to produce copies of. We suggest you check with your legal adviser and/or the relevant legal authorities if in doubt about a particular item or document:

- Currency
- Bonds or other certificates of debt
- Certificates of deposit
- Armed forces service or draft papers
- Passports

- Postage stamps (cancelled or uncanceled)
- Immigration papers
- Welfare documents
- Cheques or drafts drawn by governmental agencies
- Identifying badges or insignias

In addition, driving licences and/or Certificates of Title to motor vehicles may not be copied or scanned under certain national laws.

Copyrighted works cannot be copied or scanned lawfully, subject to the "fair dealing" exception relating to sections of a copyrighted work. Multiple copies would indicate improper use. Works of art should be considered the equivalent of copyrighted works.

## **Disclaimer**

Brother disclaims any warranties with respect to avoidance, mitigation or non-occurrence of any breakdowns, malfunctions, system crashes, virus infections, damage and disappearances of data, and any other kind of errors by using this product. AS LONG AS PERMITTED BY APPLICABLE LAWS, BROTHER WILL NOT BE LIABLE FOR ANY LOST REVENUES OR INDIRECT, SPECIAL, INCIDENTAL, CONSEQUENTIAL, EXEMPLARY, OR PUNITIVE DAMAGES OF THE CUSTOMERS OR ANY OTHER THIRD PARTY.